

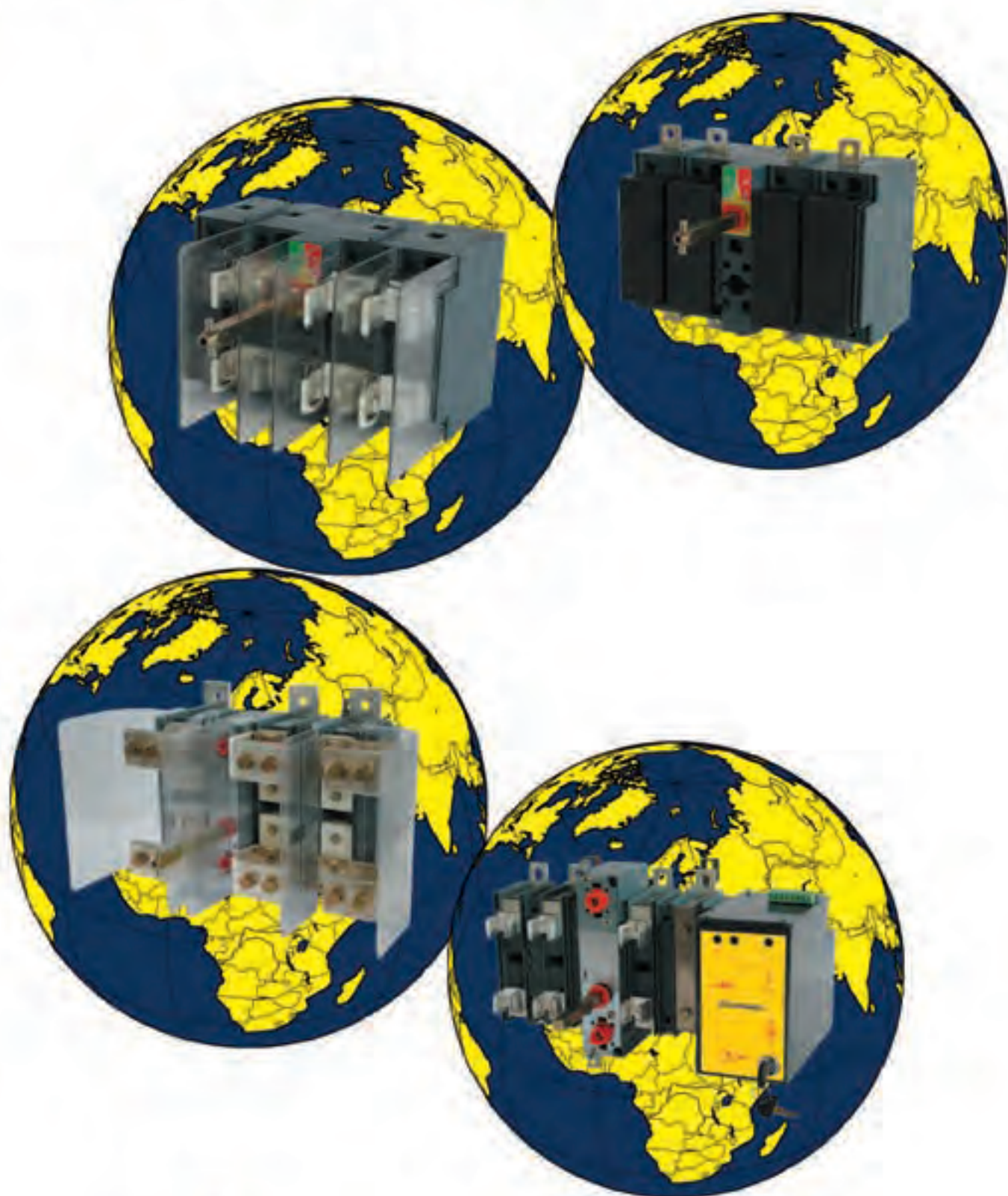

# INTERRUTTORI DI MANOVRA SEZIONATORI SWITCH-DISCONNECTORS



**Contactplasma**

RICERCA TECNOLOGICA ELETTROMECCANICA ELETTROTECNICA BT-MT  
L.V.-M.V. ELECTROMECHANICAL AND ELECTROTECHNICS TECHNOLOGICAL RESEARCH



## CARATTERISTICHE GENERALI - GENERAL CHARACTERISTICS

### Generalità

Gli interruttori di manovra-sezionatori sono apparecchi che racchiudono le funzioni di "manovra" e "sezionamento" di linee e carichi di qualsiasi tipo.

### Caratteristiche costruttive

Gli interruttori di manovra-sezionatori presentano le seguenti caratteristiche costruttive principali:

- scatola isolante in massa poliestere con caratteristiche
- autoestinguenti e antitraccia
- contatti fissi in rame elettrolitico argentati
- doppia interruzione per polo che rende possibile il collegamento della alimentazione in modo indifferente con la parte superiore od inferiore
- dispositivo di comando estremamente affidabile che garantisce un'elevata velocità di chiusura e di apertura indipendentemente dall'abilità dell'operatore
- indicazione visibile della posizione dei contatti attraverso la finestra applicata sul coperchio, nelle versioni con sezionamento visibile
- possibilità di montaggio indifferente con manovra destra o sinistra senza riduzione delle prestazioni
- una vasta gamma di accessori opzionali consente l'uso degli interruttori in molteplici installazioni
- adatti per ambienti inquinati e climi tropicali, secondo norme IEC 68-2
- interruttori quadripolari per l'interruzione omipolare delle fasi (il contatto neutro si chiude prima e si apre dopo le fasi).
- maniglia di comando con grado di protezione IP55 fornita con l'apparecchio comprendente:
  - ✓ mostrina per posizione O-I a norme IEC e ON-OFF a norme BS
  - ✓ blocco porta in posizione di chiuso
  - ✓ mostrina per fissaggio su porta
  - ✓ blocchi di sicurezza che permettono l'accesso all'interno del portello solo ad interruttore aperto, o dove presenti, la sostituzione dei fusibili solo quando gli stessi sono fuori tensione
  - ✓ possibilità di applicare max 3 lucchetti nella posizione di aperto (a richiesta può essere fornita la maniglia lucchettabile sia in posizione di interruttore aperto che chiuso).

### Nella serie con fusibili

Le versioni con fusibile oltre alla protezione delle linee assicurano i seguenti vantaggi:

- essere in grado di interrompere correnti elevate
- limitare meglio il picco ed il valore della  $I^2t$  delle più elevate correnti di guasto rispetto agli interruttori automatici e limitatori
- occupare uno spazio ridotto
- avere un costo sensibilmente inferiore rispetto agli interruttori automatici e limitatori
- operare le interruzioni di forti correnti senza manifestazioni esterne di alcun tipo
- i fusibili sono fissi; ciò garantisce una maggior durata meccanica
- il sezionamento dei fusibili avviene sia a monte che a valle, per permettere la loro sostituzione in completa sicurezza.

### Cablaggio

Versatilità di cablaggio per la possibilità di connessioni a barretta o capocorda, o con connessioni dirette, senza preparazione dei cavi, nella esecuzione con morsetti a bussola IP20.

### Bobina di sgancio (solo IHS 80A÷200A • IHF 80A÷160A)

Possibilità di montaggio, all'interno degli interruttori di una bobina di sgancio per comando di intervento a distanza. Gli interruttori-sezionatori per questa esecuzione permettono il posizionamento del comando in posizione di precarica per l'intervento della bobina.

### Maniglia di azionamento

Versioni O-OFF, I-ON, P (per impiego con bobina di sgancio)

Possibilità di blocco con tre lucchetti max, solo in posizione di O-OFF per evitare, sia manovre improprie, o l'accesso all'interno del quadro di personale non autorizzato. Possibilità d'invertire albero di comando e camma ausiliari.

### Norme di riferimento

Gli interruttori di manovra sezionatori sono costruiti in conformità alle seguenti Norme:

- ✓ CEI EN 60947-3
- ✓ NF EN 60947-3
- ✓ NBN EN 60947-3
- ✓ BS EN 60947-3

Gli interruttori della serie IHF, INF, IMF sono associati a cartucce fusibili conformi alle seguenti norme:

- ✓ CSA 22.2-14
- ✓ Internazionali: EN 60269-1
- ✓ Francesi: NFC 63-210; 63-211
- ✓ Tedesche: DIN 43620
- ✓ Inglese: BS 88

### General

The switch-disconnectors are manufactured for "breaking and isolation" of three-phase lines and loads of any type.

### Manufacturing features

The switch-disconnectors have the following main characteristics:

- polyester self-extinguishing and anti-trace insulating case
- silver-plated electrolytic copper fix contacts
- double breaking for pole, feeder connection is allowed either in the upper or lower side
- extremely reliable operating device assuring high closing and opening speed, independent from the operator
- visible indication of contacts position through inspection windows, in the visible isolation version
- installation with right or left operating handle without reducing the performances
- complete range of optional accessories allows the use of switch-disconnectors in different installations
- suitable for polluted ambient and tropical climates according to IEC 68-2 Std.
- 4 pole switch-disconnectors suitable for all phases breaking (the neutral contacts close before and opens after the phases)
- operating handle with protection degree IP55 supplied with the switch-disconnector, complete with:
  - ✓ position indication O-I according to IEC Standards and ON-OFF according to BS Standards
  - ✓ door lock in closed position
  - ✓ position indication ring for fitting on the door switch-disconnector
  - ✓ safety locks allowing the access inside the door only with switch-disconnectors in open position and in case of switch-disconnector-fuses, the fuses replacement only when the fuses are without tensions.
  - ✓ up to 3 padlocks can be fitted in open position of switch-disconnector (on request we can supply the handle padlockable either in open or closed position).

### Switch-disconnector-fuses series

In the switch-disconnector-fuses models grant protection function and have also the following advantages:

- high breaking currents
- better limitation of the peak and  $I^2t$  value of the highest fault currents compared to automatic circuit breakers
- reduced overall dimensions
- price cheaper than c. breakers
- fuses grant higher mechanical endurance
- fuses isolation upstream and downstream allowing fuses replacement under complete safety

### Wiring

Versatility of wiring through lug cable terminals, or directly without preparation of cable through IP 20 bush terminals.

### Release coil (IHS 80A÷200A • IHF 80A÷160A)

Possibility to equip the switch-disconnectors with release coil for remote tripping when the switch disconnector is pre-charged (P position)

### Operating handle

Versions O-OFF, I-ON, P (only in case of release coil application).

Up to 3 padlocks facilities in O-OFF position to avoid improper operations or the access to the panel. Switch shaft and auxiliary cams can be reversed

### Reference Standards

The switch-disconnectors are designed manufactured and tested in compliance with the following Standards:

- ✓ CEI EN 60947-3
- ✓ NF EN 60947-3
- ✓ NBN EN 60947-3
- ✓ BS EN 60947-3

Switch-disconnector-fuses IHF-INF series are associated to cartridge fuses complying with the following Standards:

- ✓ CSA 22.2-14
- ✓ International EN 60269-1
- ✓ French: NFC 63-210; 63-211
- ✓ German: DIN 43620
- ✓ British: BS 88



INTERRUTTORE DI MANOVRA-SEZIONATORE  
CON FUSIBILI, CON RIDUTTORE INTEGRALE  
CON INCORPORATO CIRCUITO ELETTRICO

SWITCH-DISCONNECTOR-FUSES, WITH REDUCTION  
GEAR INCORPORATING ELECTRICAL CIRCUIT

**INTERRUTTORI DI MANOVRA SEZIONATORI CON FUSIBILI - SWITCH-DISCONNECTOR-FUSES**

<b>IHF</b>	vedi nota C pag.42 - see note C page 42
caratteristiche elettriche - <b>electrical features</b>	page 03
foto e codici - <b>photos and codes</b>	page 04-05-06
disegni e tabelle dimensionali - <b>dimensional tables and drawings</b>	page 07
accessori (vedere H series) - <b>accessories (see H series)</b>	

<b>INF</b>	vedi nota C pag.42 - see note C page 42
caratteristiche elettriche - <b>electrical features</b>	page 03
foto e codici - <b>photos and codes</b>	page 08
disegni e tabelle dimensionali - <b>dimensional tables and drawings</b>	page 09
accessori (vedere N series) - <b>accessories (see N series)</b>	

<b>IHF (800A÷1250A)</b>	vedi nota C pag.42 - see note C page 42
caratteristiche elettriche - <b>electrical features</b>	page 03
foto e codici - <b>photos and codes</b>	page 10
disegni e tabelle dimensionali - <b>dimensional tables and drawings</b>	page 10
accessori (vedere N series) - <b>accessories (see N series)</b>	

**INTERRUTTORI DI MANOVRA SEZIONATORI - SWITCH-DISCONNECTORS**

<b>IHS</b>	vedi nota A pag.42 - see note A page 42
caratteristiche elettriche - <b>electrical features</b>	page 11
foto e codici - <b>photos and codes</b>	page 12
disegni e tabelle dimensionali - <b>dimensional tables and drawings</b>	page 13
accessori (vedere H series) - <b>accessories (see H series)</b>	

<b>INS</b>	vedi nota A pag.42 - see note A page 42
caratteristiche elettriche - <b>electrical features</b>	page 11
foto e codici - <b>photos and codes</b>	page 14
disegni e tabelle dimensionali - <b>dimensional tables and drawings</b>	page 15-16
accessori (vedere N series) - <b>accessories (see N series)</b>	

<b>INP</b>	vedi nota B pag.42 - see note B page 42
caratteristiche elettriche - <b>electrical features</b>	page 17
foto e codici - <b>photos and codes</b>	page 18 e - and 20
disegni e tabelle dimensionali - <b>dimensional tables and drawings</b>	page 18-19-20-21
accessori (vedere N series) - <b>accessories (see N series)</b>	

**MOTORIZZATI - MOTOR DRIVEN SWITCH-DISCONNECTORS**

caratteristiche generali - <b>general details</b>	page 23
---	---------

<b>IMV (125A÷200A 3-4 pole ● 125A÷1000A 6-8 pole)</b>	vedi nota A pag.42 - see note A page 42
caratteristiche elettriche - <b>electrical features</b>	page 24
foto e codici - <b>photos and codes</b>	page 25



disegni e tabelle dimensionali - <b>dimensional tables and drawings</b>	page	25
accessori (vedere N series) - <b>accessories (see N series)</b>		
<b>IMV (250A÷6300A 3-4 pole)</b>		vedi nota B pag.42 - <b>see note B page 42</b>
caratteristiche elettriche - <b>electrical features</b>	page	24
foto e codici - <b>photos and codes</b>	page	25
disegni e tabelle dimensionali - <b>dimensional tables and drawings</b>	page	26-27
accessori (vedere N series) - <b>accessories (see N series)</b>		
<b>IMF con fusibili - with fuses</b>		vedi nota C pag.42 - <b>see note C page 42</b>
caratteristiche elettriche - <b>electrical features</b>	page	28
foto e codici - <b>photos and codes</b>	page	29-30
disegni e tabelle dimensionali - <b>dimensional tables and drawings</b>	page	30
accessori (vedere N series) - <b>accessories (see N series)</b>		

## ACCESSORI - ACCESSORIES

Maniglie Rinviato - <b>Handles for door</b>	page 32	(H series)
Maniglie Dirette - <b>Direct Handles</b>	page 32	(H series)
Accessori e dime di foratura per maniglie - <b>Accessories and drilling template for handles</b>	page 33	(H series)
Accessori - <b>Accessories</b>	page 33-34	(H series)
Maniglie Rinviato - <b>Handles for door</b>	page 35-36	(N-K series)
Maniglie Dirette - <b>Direct Handles</b>	page 37	(N-K series)
Accessori e dime di foratura per maniglie - <b>Accessories and drilling template for handles</b>	page 37-38	(N-K series)
Accessori - <b>Accessories</b>	page 39-40-41	(N-K series)

TIPO (SERIE) - TYPE (SERIES)	IHF	IHF	IHF	IHF	IHF	INF	INF	INF	INF	INF	INF	INF	INF	INF	INF	INF	IHF	IHF	IHF	IHF	IHF	IHF		
CORRENTE NOMINALE A T.A. MAX 40° RATED THERMAL CURRENT AT 40° MAX A.T.	A	32	63	80	100	125	160	200	250	315	400	630	800	800	800	800	1000	1250						
NUMERO DEI POLI - NUMBER OF POLES	--	3-4	3-4	3-4	3-4	3-4	3-4	3-4	3-4	3-4	3-4	3-4	3-4	3-4	3-4	3-4	3-4	3-4						
TENSIONE D'ISOLAMENTO - RATED VOLTAGE OF ISOLATION TENSIONE DI TENUTA AD IMPULSO - IMPULSE WITHSTAND VOLTAGE	V	1000	1000	1000	1000	1000	1000	1000	1000	1000	1000	1000	1000	1000	1000	1000	1000	1000						
CORRENTE D'IMPIEGO - OPERATIONAL CURRENT AC23A CORRENTE D'IMPIEGO - OPERATIONAL CURRENT DC23A	A/kW	32/20 32/25 32/30	63/30 80/40 80/55	80/35 100/40 100/55	100/45 100/63 100/80	125/55 125/75 125/90	160/70 160/90 160/120	200/105 200/125 200/175	250/132 250/160 250/220	315/155 315/200 315/275	400/200 400/280 400/375	630/355 630/425 630/560	800/400 800/560 800/710	800/400 800/560 800/710	800/400 800/560 800/710	800/400 800/560 800/710	1000/500 1000/670 1000/710	1250/600 1000/670 800/710						
POTENZA REATTIVA - REACTIVE POWER note (1)	kVA	25	31	40	50	55	60	75	100	125	150	250	315	350	350	350	380	400						
POTERE DI CHIUSURA CONDIZIONATO DA FUSIBILE RATED SHORT-CIRCUIT MAKING CAPACITY	kA peak	100	100	100	100	100	100	100	100	100	100	100	100	100	100	100	100	100						
DURATA MECCANICA - MECHANICAL ENDURANCE	operazioni - operations	10000	10000	10000	10000	8000	8000	8000	8000	8000	8000	8000	8000	8000	8000	8000	8000	3000						
VITA ELETTRICA - ELECTRICAL LIFE	operazioni - operations	1500	1500	1500	1500	1000	1000	1000	1000	1000	1000	1000	1000	1000	1000	1000	1000	500						
FUSIBILI - FUSE TYPE		00-C	00-C	00	00	00-0	00-0	00-0	00-0	00-0	00-0	00-0	00-0	00-0	00-0	00-0	00-0	4						
POTENZA DISSIPATA PER POLO - POWER LOESS FOR POLE	W	0.5	2.2	3.5	5.5	5	6	11	12	19	28	40	63	41	64	100	100							
PESO - WEIGHT INF 3 pole	Kg	--	--	--	--	--	--	--	--	--	--	--	--	--	--	--	--							
PESO - WEIGHT INF 4 pole - 4° polo addossato - 4th leaning pole	Kg	--	--	--	--	--	--	--	--	--	--	--	--	--	--	--	--							
PESO - WEIGHT INF 4 pole - 4° polo laterale - 4th side pole	Kg	--	--	--	--	--	--	--	--	--	--	--	--	--	--	--	--							
PESO - WEIGHT INF 3 pole	Kg	--	--	--	--	--	--	--	--	--	--	--	--	--	--	--	--							
PESO - WEIGHT INF 4 pole - 4° polo addossato - 4th leaning pole	Kg	--	--	--	--	--	--	--	--	--	--	--	--	--	--	--	--							
PESO - WEIGHT INF 4 pole - 4° polo laterale - 4th side pole	Kg	--	--	--	--	--	--	--	--	--	--	--	--	--	--	--	--							
PESO - WEIGHT IHF 3 pole note (3)	Kg	0.8	0.8	0.8	0.85	0.95	0.8	0.8	0.8	0.8	0.8	0.8	0.8	0.8	0.8	0.8	0.8							
PESO - WEIGHT IHF 4 pole note (3)	Kg	0.9	0.9	0.9	0.95	1.05	0.9	0.9	0.9	0.9	0.9	0.9	0.9	0.9	0.9	0.9	0.9							
PESO - WEIGHT IHF 3 pole con bobina - with trip coil note (4)	Kg	1.4	1.58	1.4	1.58	1.5	1.68	1.4	1.58	1.5	1.68	1.4	1.58	1.5	1.68	1.4	1.58							
PESO - WEIGHT IHF 4 pole con bobina - with trip coil note (4)	Kg	1.5	1.68	1.5	1.68	1.6	1.78	1.5	1.68	1.6	1.78	1.5	1.68	1.6	1.78	1.5	1.68							
PESO - WEIGHT IHF 3 pole con bobina - with trip coil note (4)	Kg	1.4	1.58	1.4	1.58	1.5	1.68	1.4	1.58	1.5	1.68	1.4	1.58	1.5	1.68	1.4	1.58							
PESO - WEIGHT IHF 4 pole con bobina - with trip coil note (4)	Kg	1.5	1.68	1.5	1.68	1.6	1.78	1.5	1.68	1.6	1.78	1.5	1.68	1.6	1.78	1.5	1.68							
PESO - WEIGHT IHF 3 pole con bobina - with trip coil note (4)	Kg	1.4	1.58	1.4	1.58	1.5	1.68	1.4	1.58	1.5	1.68	1.4	1.58	1.5	1.68	1.4	1.58							
PESO - WEIGHT IHF 4 pole con bobina - with trip coil note (4)	Kg	1.5	1.68	1.5	1.68	1.6	1.78	1.5	1.68	1.6	1.78	1.5	1.68	1.6	1.78	1.5	1.68							
PESO - WEIGHT IHF 800A-1250A 3 pole	Kg	0.9	0.9	0.9	0.95	1.05	0.9	0.9	0.9	0.9	0.9	0.9	0.9	0.9	0.9	0.9	0.9							
PESO - WEIGHT IHF 800A-1250A 4 pole	Kg	--	--	--	--	--	--	--	--	--	--	--	--	--	--	--	--	17.4	18	19				
PESO - WEIGHT IHF 800A-1250A 3 pole	Kg	--	--	--	--	--	--	--	--	--	--	--	--	--	--	--	--	20.6	21.3	22.6				
PESO - WEIGHT IHF 800A-1250A 4 pole	Kg	--	--	--	--	--	--	--	--	--	--	--	--	--	--	--	--	18.4	19	20				
PESO - WEIGHT IHF 800A-1250A 4 pole	Kg	--	--	--	--	--	--	--	--	--	--	--	--	--	--	--	--	21.4	22.1	23.4				

note (1) a causa delle armoniche e delle tolleranze dei condensatori, i valori nominali devono essere ridotti del 33% - due to harmonics and tolerance of the capacitors, the rated values have been reduced by 33%

fusibili esclusi dalla fornitura  
fuses out of supply

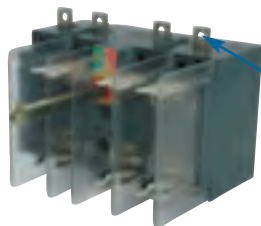
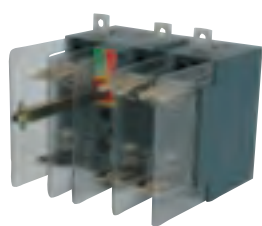

connessioni a capocorda  
lug cable terminals

fusibili DIN  
DIN fuses

codici per ordini - ordering codes

IHF \ D	32A 00C	63A 00C	80A NH00	100A NH00	125A NH00	160A NH00
3 pole	EIHF003230C5A	EIHF006330C5A	EIHF00803025A	EIHF01003025A	EIHF01253025A	EIHF01603025A
4 pole Note (1)	EIHF003240C5A	EIHF006340C5A	EIHF00804025A	EIHF01004025A	EIHF01254025A	EIHF01604025A
4 pole Note (2)	EIHF003240C5E	EIHF006340C5E	EIHF00804025E	EIHF01004025E	EIHF01254025E	EIHF01604025E
4 pole Note (3)	EIHF003240C5U	EIHF006340C5U	EIHF00804025U	EIHF01004025U	EIHF01254025U	EIHF01604025U
4 pole Note (4)	EIHF003240C5F	EIHF006340C5F	EIHF00804025F	EIHF01004025F	EIHF01254025F	EIHF01604025F

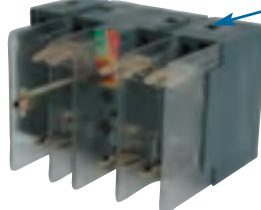
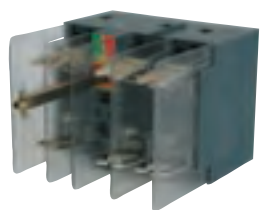

morsetti a bussola  
bush terminals

codici per ordini - ordering codes

IHF \ D	32A 00C	63A 00C	80A NH00	100A NH00
3 pole	EIHF003230C6A	EIHF006330C6A	EIHF00803026A	EIHF01003026A
4 pole Note (1)	EIHF003240C6A	EIHF006340C6A	EIHF00804026A	EIHF01004026A
4 pole Note (2)	EIHF003240C6E	EIHF006340C6E	EIHF00804026E	EIHF01004026E
4 pole Note (3)	EIHF003240C6U	EIHF006340C6U	EIHF00804026U	EIHF01004026U
4 pole Note (4)	EIHF003240C6F	EIHF006340C6F	EIHF00804026F	EIHF01004026F

Note (1) 4.to polo laterale sezionato  
4th side switched pole

Note (2) 4.to polo laterale passante non sezionabile  
4th side unswitched pole

Note (3) 4.to polo laterale passante sezionabile  
4th side switchable pole

Note (4) 4.to polo laterale sezionato con fusibile  
4th side switched pole with fuse

Per vedere le fotografie dei neutri andare a pagina 42  
See page 42 for 4<sup>th</sup> pole photos

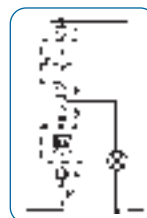

schema elettrico bobina  
release coil wiring scheme

connessioni a capocorda  
lug cable terminals



con bobina di apertura  
with release coil

con microswitch  
contatto di risparmio di intervento della bobina di apertura dell'interruttore  
with microswitch  
protection contact for release coil.

morsetti a bussola  
bush terminals

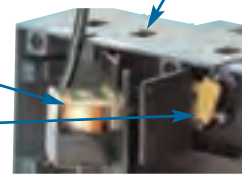

codici per ordini - ordering codes

IHF \ D	80A NH00	100A NH00	125A NH00	160A NH00
3 pole	EIHF00803025B	EIHF01003025B	EIHF01253025B	EIHF01603025B
4 pole Note (1)	EIHF00804025B	EIHF01004025B	EIHF01254025B	EIHF01604025B
4 pole Note (4)	EIHF00804025C	EIHF01004025C	EIHF01254025C	EIHF01604025C

codici per ordini - ordering codes

IHF \ D	80A NH00	100A NH00
3 pole	EIHF00803026B	EIHF01003026B
4 pole Note (1)	EIHF00804026B	EIHF01004026B
4 pole Note (4)	EIHF00804026C	EIHF01004026C

Per ordinare i sezionatori IHF con manovra inversa (I-O) vedi pagina 42 nota D.  
See page 42 note D to order IHF switches with anticlockwise operation (I-O)

nota: per gli ordini in Italia sostituire con la J la E iniziale nel codice prodotto

per le tabelle dimensionali e i disegni vedi pag. 07  
see page 07 for dimensional tables and drawings

fusibili esclusi dalla fornitura  
fuses out of supply

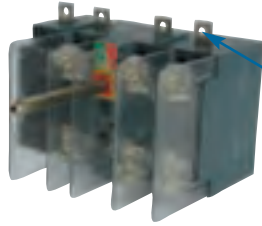
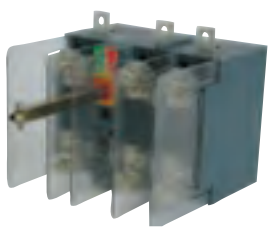

connessioni a capocorda  
lug cable terminals

fusibili BS  
BS fuses

codici per ordini - ordering codes

IHF \ B	32A A1	32A A2	63A A2-A3	80A A2-A3	100A A2-A3	125A A4	160A B1-B2
3 pole	EIHF00323085A	EIHF00323095A	EIHF00633105A	EIHF00803105A	EIHF01003105A	EIHF01253115A	EIHF01603135A
4 pole Note (1)	EIHF00324085A	EIHF00324095A	EIHF00634105A	EIHF00804105A	EIHF01004105A	EIHF01254115A	EIHF01604135A
4 pole Note (2)	EIHF00324085E	EIHF00324095E	EIHF00634105E	EIHF00804105E	EIHF01004105E	EIHF01254115E	EIHF01604135E
4 pole Note (3)	EIHF00324085U	EIHF00324095U	EIHF00634105U	EIHF00804105U	EIHF01004105U	EIHF01254115U	EIHF01604135U
4 pole Note (4)	EIHF00324085F	EIHF00324095F	EIHF00634105F	EIHF00804105F	EIHF01004105F	EIHF01254115F	EIHF01604135F

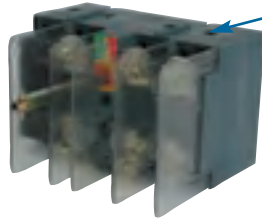

morsetti a bussola  
bush terminals

- Note (1) 4.to polo laterale sezionato  
4th side switched pole
- Note (2) 4.to polo laterale passante non sezionabile  
4th side unswitched pole
- Note (3) 4.to polo laterale passante sezionabile  
4th side switchable pole
- Note (4) 4.to polo laterale sezionato con fusibile  
4th side switched pole with fuse

Per vedere le fotografie dei neutri andare a pagina 42  
See page 42 for 4<sup>th</sup> pole photos

codici per ordini - ordering codes

IHF \ B	32A A1	32A A2	63A A2-A3	80A A2-A3	100A A2-A3
3 pole	EIHF00323086A	EIHF00323096A	EIHF00633106A	EIHF00803106A	EIHF01003106A
4 pole Note (1)	EIHF00324086A	EIHF00324096A	EIHF00634106A	EIHF00804106A	EIHF01004106A
4 pole Note (2)	EIHF00324086E	EIHF00324096E	EIHF00634106E	EIHF00804106E	EIHF01004106E
4 pole Note (3)	EIHF00324086U	EIHF00324096U	EIHF00634106U	EIHF00804106U	EIHF01004106U
4 pole Note (4)	EIHF00324086F	EIHF00324096F	EIHF00634106F	EIHF00804106F	EIHF01004106F

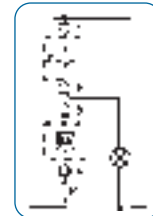

schema elettrico bobina  
release coil wiring scheme

connessioni a capocorda  
lug cable terminals

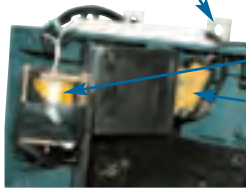

con bobina di apertura  
with release coil

con microswitch  
contatto di risparmio di intervento della bobina di apertura dell'interruttore  
with microswitch  
protection contact for release coil.

morsetti a bussola  
bush terminals

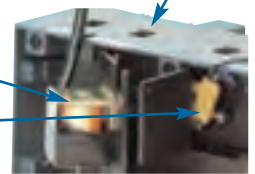

codici per ordini - ordering codes

IHF \ B	80A A2-A3	100A A2-A3	125A A4	160A B1-B2
3 pole	EIHF00803105B	EIHF01003105B	EIHF01253115B	EIHF01603115B
4 pole Note (1)	EIHF00804105B	EIHF01004105B	EIHF01254115B	EIHF01604115B
4 pole Note (4)	EIHF00804105C	EIHF01004105C	EIHF01254115C	EIHF01604115C

codici per ordini - ordering codes

IHF \ B	80A A2-A3	100A A2-A3
3 pole	EIHF00803106B	EIHF01003106B
4 pole Note (1)	EIHF00804106B	EIHF01004106B
4 pole Note (4)	EIHF00804106C	EIHF01004106C

Per ordinare i sezionatori IHF con manovra inversa (I-0) vedi pagina 42 nota D.  
See page 42 note D to order IHF switches with anticlockwise operation (I-0)

nota: per gli ordini in Italia sostituire con la J la E iniziale nel codice prodotto

per le tabelle dimensionali e i disegni vedi pag. 07  
see page 07 for dimensional tables and drawings

fusibili esclusi dalla fornitura  
fuses out of supply

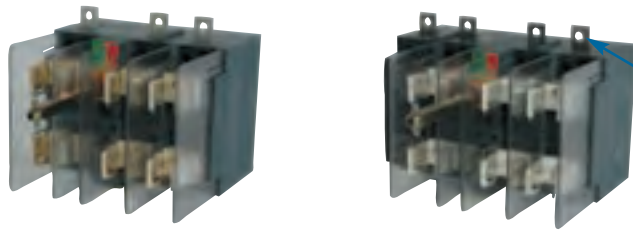

connessioni a capocorda  
lug cable terminals

fusibili NFC  
NFC fuses

codici per ordini - ordering codes

IHF \ N	32A 14x51	63A 14x51	80A 22x58	100A 22x58	125A 22x58
3 pole	EIHF00323065A	EIHF00633065A	EIHF00803075A	EIHF01003075A	EIHF01253075A
4 pole Note (1)	EIHF00324065A	EIHF00634065A	EIHF00804075A	EIHF01004075A	EIHF01254075A
4 pole Note (2)	EIHF00324065E	EIHF00634065E	EIHF00804075E	EIHF01004075E	EIHF01254075E
4 pole Note (3)	EIHF00324065U	EIHF00634065U	EIHF00804075U	EIHF01004075U	EIHF01254075U
4 pole Note (4)	EIHF00324065F	EIHF00634065F	EIHF00804075F	EIHF01004075F	EIHF01254075F

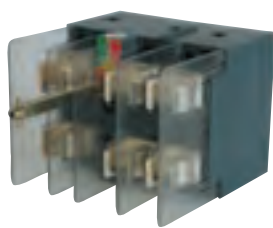

morsetti a bussola  
bush terminals

codici per ordini - ordering codes

IHF \ N	32A 14x51	63A 14x51	80A 22x58	100A 22x58
3 pole	EIHF00323066A	EIHF00633066A	EIHF00803076A	EIHF01003076A
4 pole Note (1)	EIHF00324066A	EIHF00634066A	EIHF00804076A	EIHF01004076A
4 pole Note (2)	EIHF00324066E	EIHF00634066E	EIHF00804076E	EIHF01004076E
4 pole Note (3)	EIHF00324066U	EIHF00634066U	EIHF00804076U	EIHF01004076U
4 pole Note (4)	EIHF00324066F	EIHF00634066F	EIHF00804076F	EIHF01004076F

- Note (1) 4.to polo laterale sezionato  
4th side switched pole
- Note (2) 4.to polo laterale passante non sezionabile  
4th side unswitched pole
- Note (3) 4.to polo laterale passante sezionabile  
4th side switchable pole
- Note (4) 4.to polo laterale sezionato con fusibile  
4th side switched pole with fuse

Per vedere le fotografie dei neutri andare a pagina 42  
See page 42 for 4<sup>th</sup> pole photos

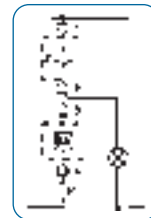

schema elettrico bobina  
release coil wiring scheme

connessioni a capocorda  
lug cable terminals

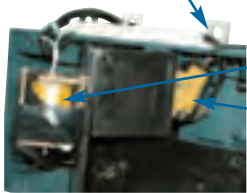

con bobina di apertura  
with release coil

con microswitch  
contatto di risparmio di intervento della bobina di apertura dell'interruttore  
with microswitch  
protection contact for release coil.

morsetti a bussola  
bush terminals



codici per ordini - ordering codes

IHF \ N	80A 22x58	100A 22x58	125A 22x58
3 pole	EIHF00803075B	EIHF01003075B	EIHF01253075B
4 pole Note (1)	EIHF00804075B	EIHF01004075B	EIHF01254075B
4 pole Note (4)	EIHF00804075C	EIHF01004075C	EIHF01254075C

codici per ordini - ordering codes

IHF \ N	80A 22x58	100A 22x58
3 pole	EIHF00803076B	EIHF01003076B
4 pole Note (1)	EIHF00804076B	EIHF01004076B
4 pole Note (4)	EIHF00804076C	EIHF01004076C

Per ordinare i sezionatori IHF con manovra inversa (I-O) vedi pagina 42 nota D.  
See page 42 note D to order IHF switches with anticlockwise operation (I-O)

nota: per gli ordini in Italia sostituire con la J la E iniziale nel codice prodotto

per le tabelle dimensionali e i disegni vedi pag. 07  
see page 07 for dimensional tables and drawings



IHF 32A÷100A 3-4 poli  
IHF 32A÷100A 3-4 pole

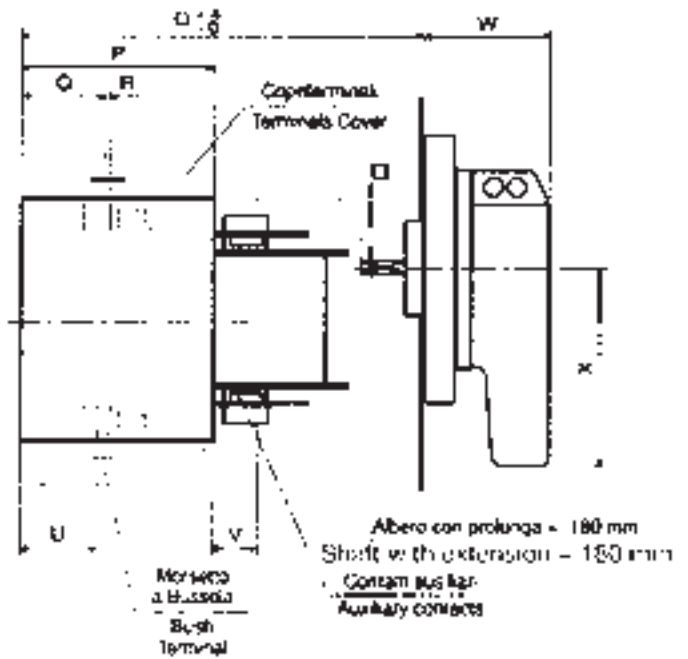
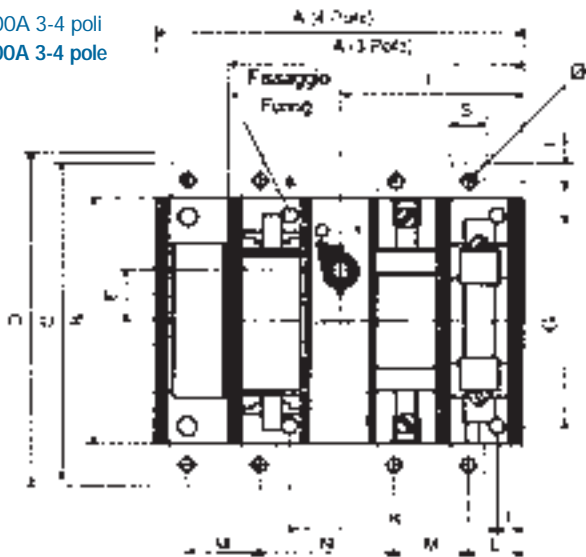

	A	A	B	C	D	E	F	G	H	I	L	M	N	O	O	O	P	Q	R	S	T	U	V	W	X	*	∅	□
	3 pole	4 pole												DIN	BS	NFC												
IHF 32A IHF 63A	100	126	86	106	142	18	63	74,5	71,5	8	19	25	46,5	135	122	122	64	28	2	11	5	26	18	44	60	4,5	5	6
IHF 80A IHF 100A	129	160	100	129	174	20	80	85	88	15,5	29	33	54	158	158	158	88	37,5	2,5	14	7	29,5	18	44	85	5,5	6	8

IHF 125A÷160A 3-4 poli  
IHF 125A÷160A 3-4 pole

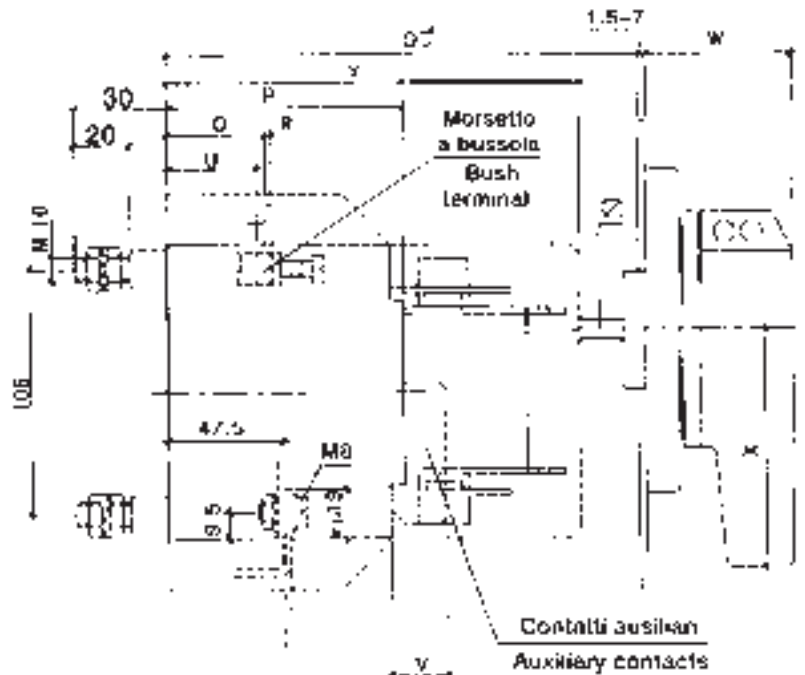
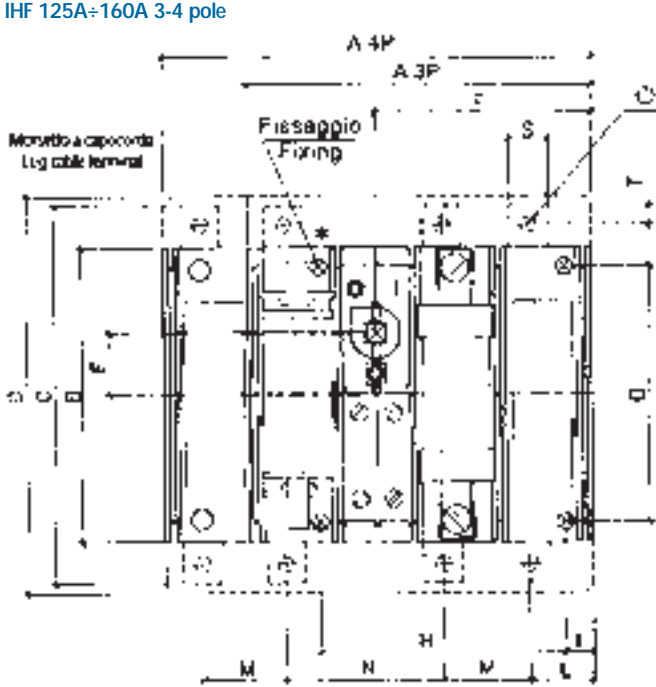

	A	A	B	C	D	E	F	G	H	I	L	M	N	O	P	Q	R	S	T	U	V	W	X	Y	*	∅	□
	3 pole	4 pole																									
IHF 125A IHF 160A	174	204	125	175	219	24	102	110	110	12	35	44	66	186	105	44,5	3	25	10	37	18	44	85	157	05,5	08,5	8

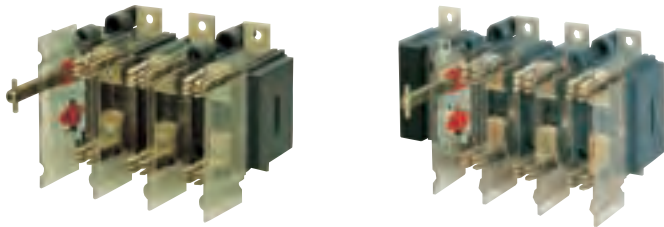

fusibili DIN  
DIN fuses

fusibili esclusi  
dalla fornitura  
fuses out of supply

codici per ordini - ordering codes

INF \ D	63A NH00	100A NH00	125A NH0	125A NH00	160A NH0	160A NH00	250A NH1-2	400A NH1-2	630A NH3
3 pole	EINF00633020A	EINF01003020A	EINF01253010A	EINF01253020A	EINF01603010A	EINF01603020A	EINF02503030A	EINF04003040A	EINF06303050A
4 pole Note (5)	EINF00634021A	EINF01004021A	EINF01254011A	EINF01254021A	EINF01604011A	EINF01604021A	EINF02504031A	EINF04004041A	EINF06304051A
4 pole Note (1)	EINF00634022A	EINF01004022A	EINF01254012A	EINF01254022A	EINF01604012A	EINF01604022A	EINF02504032A	EINF04004042A	EINF06304052A
4 pole Note (6)	EINF00634023A	EINF01004023A	EINF01254013A	EINF01254023A	EINF01604013A	EINF01604023A	EINF02504033A	EINF04004043A	EINF06304053A
4 pole Note (2)	EINF00634024A	EINF01004024A	EINF01254014A	EINF01254024A	EINF01604014A	EINF01604024A	EINF02504034A	EINF04004044A	EINF06304054A
4 pole Note (3)	EINF00634027A	EINF01004027A	EINF01254017A	EINF01254027A	EINF01604017A	EINF01604027A	EINF02504037A	EINF04004047A	EINF06304057A
4 pole Note (4)	EINF00634028A	EINF01004028A	EINF01254018A	EINF01254028A	EINF01604018A	EINF01604028A	EINF02504038A	EINF04004048A	EINF06304058A
4 pole Note (7)	EINF00634029A	EINF01004029A	EINF01254019A	EINF01254029A	EINF01604019A	EINF01604029A	EINF02504039A	EINF04004049A	EINF06304059A



fusibili BS  
BS fuses

codici per ordini - ordering codes

INF \ B	63A A2-A3	100A A2-A3	125A A4	160A B1-B2	200A B1-B2	250A B1-B3	315A B2-B3	400A B1-B4	630A C1-C2	800A C1-C3
3 pole	EINF00633100A	EINF01003100A	EINF01253110A	EINF01603130A	EINF02003130A	EINF02503140A	EINF03153150A	EINF04003150A	EINF06303170A	EINF08003180A
4 pole Note (5)	EINF00634101A	EINF01004101A	EINF01254111A	EINF01604131A	EINF02004131A	EINF02504141A	EINF03154151A	EINF04004151A	EINF06304171A	EINF08004181A
4 pole Note (1)	EINF00634102A	EINF01004102A	EINF01254112A	EINF01604132A	EINF02004132A	EINF02504142A	EINF03154152A	EINF04004152A	EINF06304172A	EINF08004182A
4 pole Note (6)	EINF00634103A	EINF01004103A	EINF01254113A	EINF01604133A	EINF02004133A	EINF02504143A	EINF03154153A	EINF04004153A	EINF06304173A	EINF08004183A
4 pole Note (2)	EINF00634104A	EINF01004104A	EINF01254114A	EINF01604134A	EINF02004134A	EINF02504144A	EINF03154154A	EINF04004154A	EINF06304174A	EINF08004184A
4 pole Note (3)	EINF00634107A	EINF01004107A	EINF01254117A	EINF01604137A	EINF02004137A	EINF02504147A	EINF03154157A	EINF04004157A	EINF06304177A	EINF08004187A
4 pole Note (4)	EINF00634108A	EINF01004108A	EINF01254118A	EINF01604138A	EINF02004138A	EINF02504148A	EINF03154158A	EINF04004158A	EINF06304178A	EINF08004188A
4 pole Note (7)	EINF00634109A	EINF01004109A	EINF01254119A	EINF01604139A	EINF02004139A	EINF02504149A	EINF03154159A	EINF04004159A	EINF06304178A	EINF08004189A

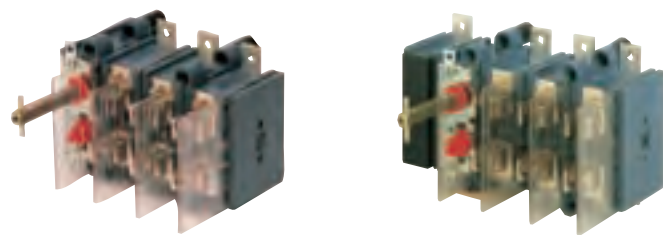

fusibili NFC  
NFC fuses

codici per ordini - ordering codes

INF \ N	63A 22x58	80A 22x58	100A 22x58	125A 22x58
3 pole	EINF00633070A	EINF00803070A	EINF01003070A	EINF01253070A
4 pole Note (5)	EINF00634071A	EINF00804071A	EINF01004071A	EINF01254071A
4 pole Note (1)	EINF00634072A	EINF00804072A	EINF01004072A	EINF01254072A
4 pole Note (6)	EINF00634073A	EINF00804073A	EINF01004073A	EINF01254073A
4 pole Note (2)	EINF00634074A	EINF00804074A	EINF01004074A	EINF01254074A
4 pole Note (3)	EINF00634077A	EINF00804077A	EINF01004077A	EINF01254077A
4 pole Note (4)	EINF00634078A	EINF00804078A	EINF01004078A	EINF01254078A
4 pole Note (7)	EINF00634079A	EINF00804079A	EINF01004079A	EINF01254079A

- Note (5) 4.to polo addossato sezionato  
**4th leaning switched pole**
- Note (1) 4.to polo laterale sezionato  
**4th side switched pole**
- Note (6) 4.to polo addossato passante non sezionabile  
**4th leaning unswitched pole**
- Note (2) 4.to polo laterale passante non sezionabile  
**4th side unswitched pole**
- Note (3) 4.to polo laterale passante sezionabile  
**4th side switchable pole**
- Note (4) 4.to polo laterale sezionato con fusibile  
**4th side switched pole with fuse**
- Note (7) 4.to polo laterale sezionato, che porta con continuità una corrente doppia della nominale  
**4th side switched pole, can carry the double of the rated current**

Per vedere le fotografie dei neutri andare a pagina 42  
See page 42 for 4th pole photos

Per ordinare i sezionatori INF con manovra inversa (I-0) vedi pagina 42 nota D. See page 42 note D to order INF switches with anticlockwise operation (I-0)

nota: per gli ordini in Italia sostituire con la J la E iniziale nel codice prodotto

per le tabelle dimensionali e i disegni vedi pag. 09  
see page 09 for dimensional tables and drawings

INF 63A÷800A 3 poli  
 INF 63A÷800A 4° polo addossato  
 INF 63A÷800A 3 pole  
 INF 63A÷800A 4<sup>th</sup> leaning pole

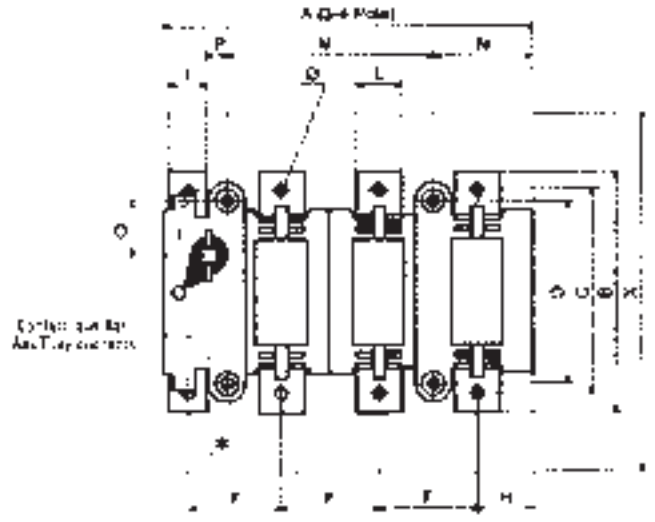
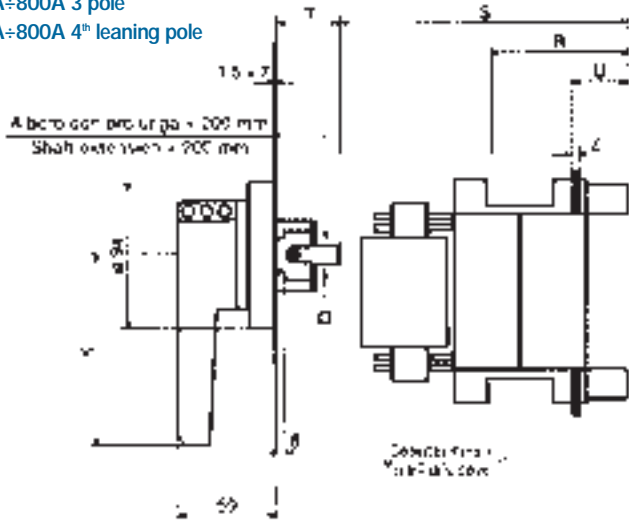

	A	B	C	Ø	D	F	H	I	K	L	M	N	O	P	R	S	T	U	Z	X	□	*
	3-4 pole																					
INF 63A	181	141	113	8,5	107	44	32	16	125	20	98	51	33	6	72	150	36	29	3	178	10	5,5
INF 100A																						
INF 125A																						
INF 160A																						
INF 200A																						
INF 250A	251	161	136	10,5	119	65	42	25	125	25	137	72	36	12	90	197	35	36	4	234	12	6,5
INF 315A										30												
INF 400A										30												
INF 630A	325	238	200	12,5	176	87	49	36	165	40	174	92	64	19,5	108	230	40	48	6	333	12	7
INF 800A																			10			

INF 63A÷800A 4° polo laterale  
 INF 63A÷800A 4<sup>th</sup> side pole

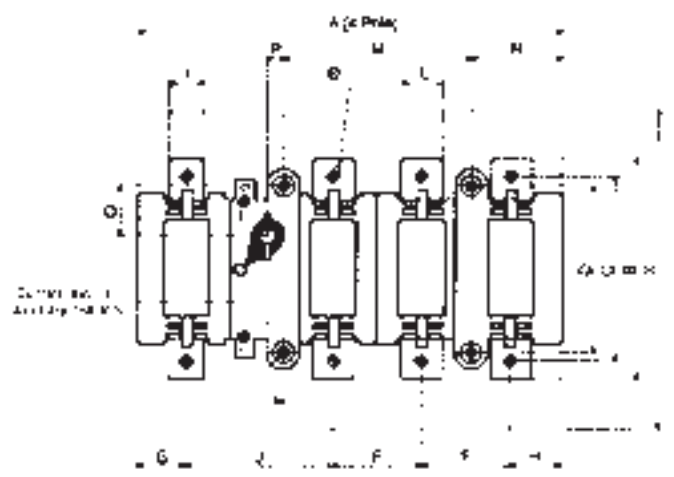
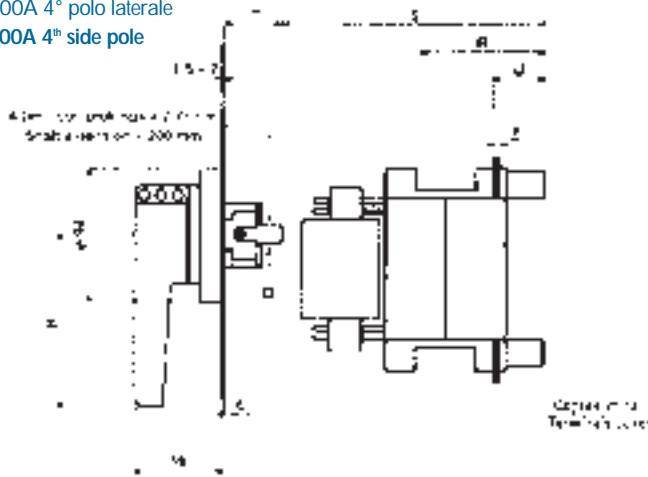

	A	B	C	Ø	D	F	H	I	K	L	M	N	O	P	R	S	T	U	Z	X	□	*	J	G
	4 pole																							
INF 63A	222	133	113	8,5	107	44	32	20	125	20	98	51	33	6	72	150	36	29	3	178	10	5,5	82	20
INF 100A																								
INF 125A																								
INF 160A																								
INF 200A																								
INF 250A	306	161	136	10,5	119	65	42	25	125	25	137	72	36	12	90	197	35	36	4	234	12	6,5	109	25
INF 315A								30		30														
INF 400A								30		30														
INF 630A	378	238	200	12,5	176	87	49	40	165	40	174	92	64	19,5	108	230	40	48	6	333	12	7	130	25
INF 800A																			10					

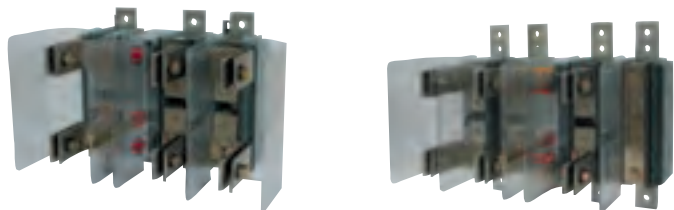

fusibili DIN  
DIN fuses

fusibili esclusi dalla fornitura  
fuses out of supply

codici per ordini - ordering codes

IHF \ D	800A NH4	1000A NH4	1250A NH4
3 pole	EIHF08003080A	EIHF10003080A	EIHF12503080A
4 pole Note (1)	EIHF08004082A	EIHF10004082A	EIHF12504082A
4 pole Note (2)	EIHF08004084A	EIHF10004084A	EIHF12504084A
4 pole Note (3)	EIHF08004087A	EIHF10004087A	EIHF12504087A
4 pole Note (4)	EIHF08004088A	EIHF10004088A	EIHF12504088A
4 pole Note (7)	EIHF08004089A	EIHF10004089A	EIHF12504089A

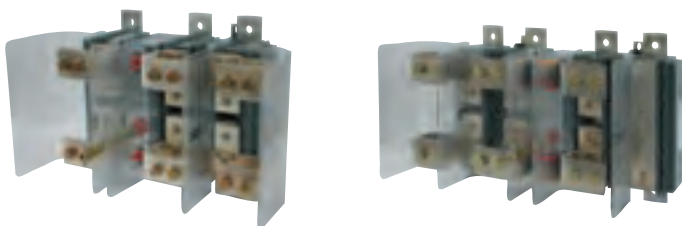

fusibili BS  
BS fuses

codici per ordini - ordering codes

IHF \ B	800A C3-D1	1000A D1	1250A D1
3 pole	EIHF08003190A	EIHF10003190A	EIHF12503190A
4 pole Note (1)	EIHF08004192A	EIHF10004192A	EIHF12504192A
4 pole Note (2)	EIHF08004194A	EIHF10004194A	EIHF12504194A
4 pole Note (3)	EIHF08004197A	EIHF10004197A	EIHF12504197A
4 pole Note (4)	EIHF08004198A	EIHF10004198A	EIHF12504198A
4 pole Note (7)	EIHF08004199A	EIHF10004199A	EIHF12504199A

- Note (1) 4.to polo laterale sezionato  
**4th side switched pole**
- Note (2) 4.to polo laterale passante non sezionabile  
**4th side unswitched pole**
- Note (3) 4.to polo laterale passante sezionabile  
**4th side switchable pole**
- Note (4) 4.to polo laterale sezionato con fusibile  
**4th side switched pole with fuse**
- Note (7) 4.to polo laterale sezionato, che porta con continuità una corrente doppia della nominale  
**4th side switched pole, can carry the double of the rated current**

Per vedere le fotografie dei neutri andare a pagina 42  
See page 42 for 4<sup>th</sup> pole photos

Per ordinare i sezionatori IHF con manovra inversa (I-0) vedi pagina 42 nota D.  
See page 42 note D to order IHF switches with anticlockwise operation (I-0)  
nota: per gli ordini in Italia sostituire con la J la E iniziale nel codice prodotto

IHF 800A÷1250A 3-4 poli  
IHF 800A÷1250A 3-4 pole



	A	A	A <sub>1</sub>	A <sub>1</sub>	A <sub>2</sub>	A <sub>2</sub>	A <sub>3</sub>	A <sub>3</sub>	B	B <sub>1</sub>	M	M	N	N	P	P	Z
	3 pole	4 pole	3 pole	4 pole	3 pole	4 pole	3 pole	4 pole			3 pole	4 pole	3 pole	4 pole	3 pole	4 pole	
IHF 800A									292		10	82	115	109	83	89	8
IHF 1000A	320,5	392	375	446,5	424,5	514,5	172	262,5									10
IHF 1250A										352							10



caratteristiche tecniche - technical characteristics

IHS / INS (da pagina 12 a pagina 16 - from page 12 to page 16)

TIPO (SERIE) - TYPE (SERIES)	medium case										big case									
	IHS	IHS	IHS	IHS	IHS	IHS	IHS	IHS	INS	INS	IHS	IHS	IHS	IHS	IHS	IHS	IHS	IHS	INS	INS
CORRENTE NOMINALE A T.A. MAX 40° RATED THERMAL CURRENT AT 40° MAX A.T.	in aria libera free air	A	32	63	80	100	125	160	200	250	63	100	125	160	200	250	315	400	630	800
	in cassetta box	A	32	50	80	100	125	160	200	250	63	100	125	150	160	250	300	340	550	630
NUMERO DEI POLI - NUMBER OF POLES	--	--	3-4-6-8	3-4-6-8	3-4-6-8	3-4-6-8	3-4-6-8	3-4-6-8	3-4-6-8	3-4-6-8	3-4-6-8	3-4-6-8	3-4-6-8	3-4-6-8	3-4-6-8	3-4-6-8	3-4-6-8	3-4-6-8	3-4-6-8	3-4-6-8
TENSIONE D'ISOLAMENTO RATED VOLTAGE OF ISOLATION	U <sub>i</sub>	V	1000	1000	1000	1000	1000	1000	1000	1000	1000	1000	1000	1000	1000	1000	1000	1000	1000	1000
TENSIONE DI TENUTA AD IMPULSO - IMPULSE WITHSTAND VOLTAGE	--	kV	6	6	6	6	6	6	6	6	8	8	8	8	8	8	8	8	8	8
CORRENTE D'IMPIEGO - OPERATIONAL CURRENT AC23A	I <sub>e</sub>	A/kW	32/20	63/30	80/40	100/45	125/55	160/75	200/96	250/132	63/35	100/45	125/55	160/75	200/105	250/132	315/155	400/200	630/355	800/400
CORRENTE D'IMPIEGO - OPERATIONAL CURRENT DC23A	I <sub>e</sub>	A	32/25	63/40	80/50	100/65	125/75	160/100	200/120	250/160	63/40	100/65	125/75	160/100	200/125	250/160	315/200	400/280	630/425	800/560
CORRENTE D'IMPIEGO - OPERATIONAL CURRENT AC22A	I <sub>e</sub>	A	32/30	63/45	80/65	100/90	125/90	160/140	200/175	250/220	63/50	100/80	125/90	160/140	200/175	250/220	315/275	400/375	630/475	800/710
POTENZA REATTIVA - REACTIVE POWER note (1)	I <sub>crw</sub>	kVAR	30	35	40	50	55	70	80	110	35	50	60	75	100	125	150	250	315	400
CORRENTE DI BREVE DURATA RATED SHORT-TIME WITHSTAND CURRENT	I <sub>cm</sub>	kA	4	4	5	5	6	10	10	12,5	4	5	8	10	10	12,5	15	18	20	25
POTERE DI CHIUSURA IN C.T.O C.TO RATED SHORT-CIRCUIT MAKING CAPACITY	I <sub>cm</sub>	kA peak	10	10	12	12	15	25	25	31	10	12	20	25	25	31	37	44	50	63
DURATA MECCANICA - MECHANICAL ENDURANCE	operazioni - operations	n°	10000	10000	10000	10000	8000	8000	8000	8000	10000	10000	8000	8000	8000	8000	8000	5000	5000	3000
VITA ELETTRICA - ELECTRICAL LIFE	operazioni - operations	n°	1500	1500	1500	1500	1000	1000	1000	1000	1500	1500	1000	1000	1000	1000	1000	1000	1000	500
POTENZA DISSIPATA PER POLO - POWER LOSS FOR POLE	--	W	0,4	1,5	2,5	3,9	6	6	7,5	16	0,8	2	3,1	5,1	8	8,2	13	20	50	55
PESO - WEIGHT INS 3 pole - con barre - with bars	--	Kg	--	--	--	--	--	--	--	--	2,7	2,7	2,7	2,7	4,6	4,7	4,7	5,1	9,5	10,6
PESO - WEIGHT INS 4 pole - con barre - with bars • 4° polo addossato-4th leaning pole	--	Kg	--	--	--	--	--	--	--	--	2,8	2,8	2,8	2,8	4,8	4,9	4,9	5,6	10	11,2
PESO - WEIGHT INS 4 pole - con barre - with bars • 4° polo laterale-4th side pole	--	Kg	--	--	--	--	--	--	--	--	3	3	3	3	5,1	5,3	5,3	6,1	11	12,5
PESO - WEIGHT INS 3 pole - sezionamento visibile - visible isolation	--	Kg	--	--	--	--	--	--	--	--	2,4	2,4	2,4	2,4	4,4	4,5	4,5	--	8,4	9,8
PESO - WEIGHT INS 4 pole - S.V. - visible isolation • 4° polo addossato-4th leaning pole	--	Kg	--	--	--	--	--	--	--	--	2,5	2,5	2,5	2,5	4,6	4,7	4,7	--	8,9	10,4
PESO - WEIGHT INS 4 pole - S.V. - visible isolation • 4° polo laterale-4th side pole	--	Kg	--	--	--	--	--	--	--	--	2,7	2,7	2,7	2,7	4,9	5	5	--	9,7	11,5
PESO - WEIGHT INS 6 pole	--	Kg	--	--	--	--	--	--	--	--	2,7	2,7	2,7	2,7	4,6	4,7	4,7	4,8	9,6	10,4
PESO - WEIGHT INS 8 pole	--	Kg	--	--	--	--	--	--	--	--	3,1	3,1	3,1	3,1	5,4	5,5	5,5	5,8	11,6	12,5
PESO - WEIGHT IHS 3 pole note (3) - IHS 3 pole con bobina - with trip coil note (4)	--	Kg	0,75	0,75	1,3	1,48	1,3	1,48	2,1	2,3	2,1	2,3	2,1	2,3	2,1	2,3	2,1	2,3	--	--
PESO - WEIGHT IHS 4 pole note (3) - IHS 4 pole con bobina - with trip coil note (4)	--	Kg	0,85	0,85	1,4	1,58	1,4	1,58	2,5	2,7	2,5	2,7	2,5	2,7	2,5	2,7	2,5	2,7	--	--
PESO - WEIGHT IHS 6 pole note (3) - IHS 6 pole con bobina - with trip coil note (4)	--	Kg	0,8	0,8	1,4	1,58	1,4	1,58	2,3	2,3	2,3	2,3	2,3	2,3	2,3	2,3	2,3	2,3	--	--
PESO - WEIGHT IHS 8 pole note (3) - IHS 8 pole con bobina - with trip coil note (4)	--	Kg	0,9	0,9	1,5	1,68	1,5	1,68	2,5	2,7	2,5	2,7	2,5	2,7	2,5	2,7	2,5	2,7	--	--

note (1) a causa delle armoniche e delle tolleranze dei condensatori, i valori nominali devono essere ridotti del 33% - due to harmonics and tolerance of the capacitors, the rated values have been reduced by 33%



codici per ordini - ordering codes

IHS	32A	63A	80A	100A	125A	160A	200A	250A
3 pole	EIHS00323005A	EIHS00633005A	EIHS00803005A	EIHS01003005A	EIHS01253005A	EIHS01603005A	EIHS02003005A	EIHS02503005A
4 pole Note (1)	EIHS00324005A	EIHS00634005A	EIHS00804005A	EIHS01004005A	EIHS01254005A	EIHS01604005A	EIHS02004005A	EIHS02504005A
4 pole Note (2)	EIHS00324005E	EIHS00634005E	EIHS00804005E	EIHS01004005E	EIHS01254005E	EIHS01604005E	EIHS02004005E	EIHS02504005E
4 pole Note (3)	EIHS00324005U	EIHS00634005U	EIHS00804005U	EIHS01004005U	EIHS01254005U	EIHS01604005U	EIHS02004005U	EIHS02504005U



codici per ordini - ordering codes

IHS	32A	63A	80A	100A	125A
3 pole	EIHS00323006A	EIHS00633006A	EIHS00803006A	EIHS01003006A	EIHS01253006A
4 pole Note (1)	EIHS00324006A	EIHS00634006A	EIHS00804006A	EIHS01004006A	EIHS01254006A
4 pole Note (2)	EIHS00324006E	EIHS00634006E	EIHS00804006E	EIHS01004006E	EIHS01254006E
4 pole Note (3)	EIHS00324006U	EIHS00634006U	EIHS00804006U	EIHS01004006U	EIHS01254006U

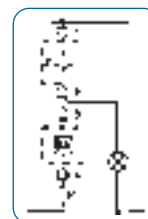

schema elettrico bobina  
 release coil wiring scheme

con bobina di apertura with release coil  
 connessioni a capocorda lug cable terminals  
 con microswitch  
 contatto di risparmio di intervento della bobina di apertura dell'interruttore with microswitch  
 protection contact for release coil.

codici per ordini - ordering codes

IHS	80A	100A	125A	160A	200A	250A
3 pole	EIHS00803005B	EIHS01003005B	EIHS01253005B	EIHS01603005B	EIHS02003005B	EIHS02503005B
4 pole	EIHS00804005B	EIHS01004005B	EIHS01254005B	EIHS01604005B	EIHS02004005B	EIHS02504005B

con bobina di apertura with release coil  
 morsetti a bussola bush terminals  
 con microswitch  
 contatto di risparmio di intervento della bobina di apertura dell'interruttore with microswitch  
 protection contact for release coil.

codici per ordini - ordering codes

IHS	80A	100A	125A
3 pole	EIHS00803006B	EIHS01003006B	EIHS01253006B
4 pole	EIHS00804006B	EIHS01004006B	EIHS01254006B

Per ordinare i sezionatori IHS con manovra inversa (I-0) vedi pagina 48 nota D.  
 See page 48 note D to order IHS switches with anticlockwise operation (I-0)

nota: per gli ordini in Italia sostituire con la J la E iniziale nel codice prodotto

Note (1) 4.to polo laterale sezionato  
 4th side switched pole

Note (2) 4.to polo laterale passante non sezionabile  
 4th side unswitched pole

Note (3) 4.to polo laterale passante sezionabile  
 4th side switchable pole

Per vedere le fotografie dei neutri andare a pagina 48  
 See page 48 for 4<sup>th</sup> pole photos

IHS 32A÷125A 3-4 poli  
 IHS 32A÷125A 3-4 pole

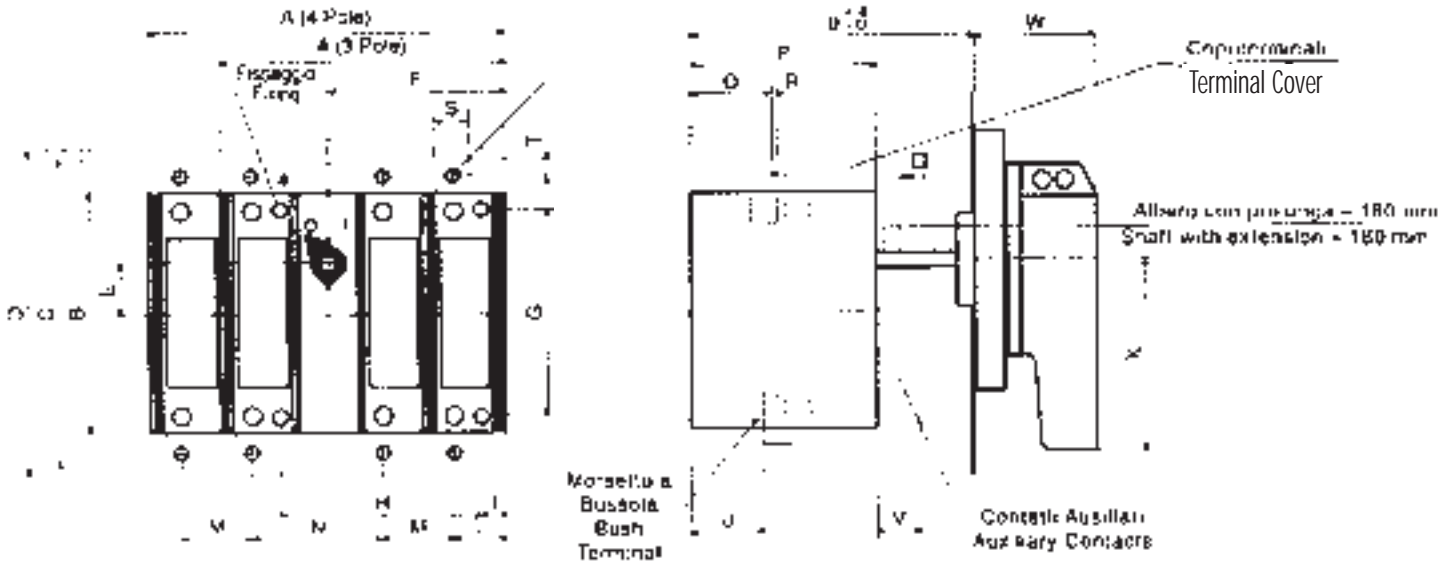

	A	A	B	C	D	E	F	G	H	I	L	M	N	O	P	Q	R	S	T	U	V	W	X	*	Ø	□
	3 pole	4 pole																								
IHS 32A	100	126	86	106	142	18	63	74,5	71,5	8	19	25	46,5	97	64	28	2	11	5	26	18	44	60	4,5	5	6
IHS 63A																										
IHS 80A																										
IHS 100A	129	160	100	129	174	20	80	85	88	15,5	29	33	54	129	88	37,5	2,5	14	7	29,5	18	44	85	5,5	6	8
IHS 125A																										

IHS 160A÷250A 3-4 poli  
 IHS 160A÷250A 3-4 pole

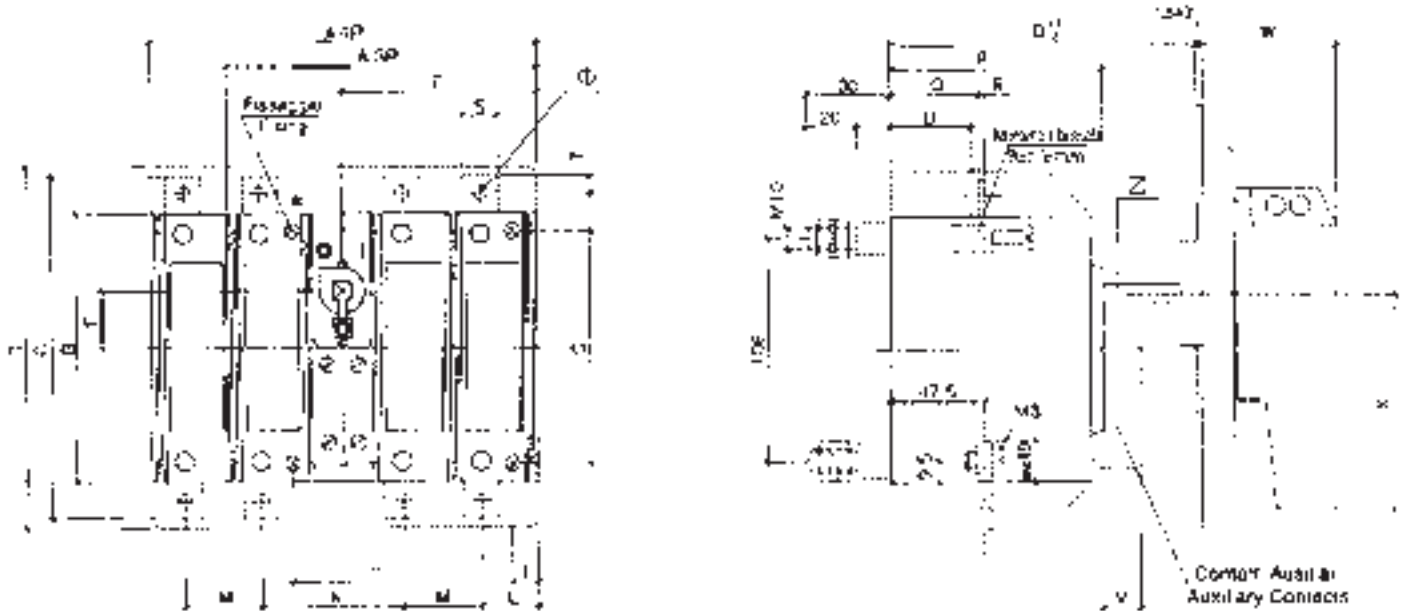

	A	A	B	C	D	E	F	G	H	I	L	M	N	O	P	Q	R	S	T	U	V	W	X	*	Ø	□
	3 pole	4 pole																								
IHS 160A																										
IHS 200A	174	204	125	175	219	24	102	110	110	12	35	44	66	130	105	44,5	3	25	10	37	18	44	85	05,5	08,5	8
IHS 250A																										

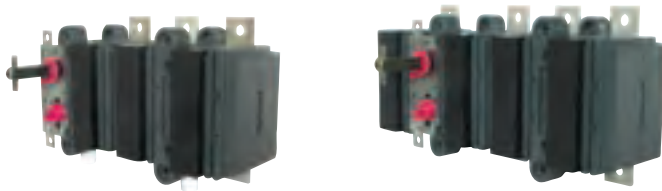

con barrette e copribarrette  
with bars and link bar covers



codici per ordini - ordering codes

INS\b									medium case	big case		
	63A	100A	125A	160A	200A	250A	315A	400A	630A	630A	800A	1000A
3 pole	EINS00633220A	EINS01003220A	EINS01253220A	EINS01603220A	EINS02003220A	EINS02503220A	EINS03153220A	EINS04003220A	EINS06303210A	EINS06303220A	EINS08003220A	EINS10003220A
4 pole Note (5)	EINS00634221A	EINS01004221A	EINS01254221A	EINS01604221A	EINS02004221A	EINS02504221A	EINS03154221A	EINS04004221A	EINS06304211A	EINS06304221A	EINS08004221A	EINS10004221A
4 pole Note (1)	EINS00634222A	EINS01004222A	EINS01254222A	EINS01604222A	EINS02004222A	EINS02504222A	EINS03154222A	EINS04004222A	EINS06304212A	EINS06304222A	EINS08004222A	EINS10004222A
4 pole Note (6)	EINS00634223A	EINS01004223A	EINS01254223A	EINS01604223A	EINS02004223A	EINS02504223A	EINS03154223A	EINS04004223A	EINS06304213A	EINS06304223A	EINS08004223A	EINS10004223A
4 pole Note (2)	EINS00634224A	EINS01004224A	EINS01254224A	EINS01604224A	EINS02004224A	EINS02504224A	EINS03154224A	EINS04004224A	EINS06304214A	EINS06304224A	EINS08004224A	EINS10004224A
4 pole Note (3)	EINS00634227A	EINS01004227A	EINS01254227A	EINS01604227A	EINS02004227A	EINS02504227A	EINS03154227A	EINS04004227A	EINS06304217A	EINS06304227A	EINS08004227A	EINS10004227A
4 pole Note (7)	EINS00634229A	EINS01004229A	EINS01254229A	EINS01604229A	EINS02004229A	EINS02504229A	EINS03154229A	EINS04004229A	EINS06304219A	EINS06304229A	EINS08004229A	EINS10004229A

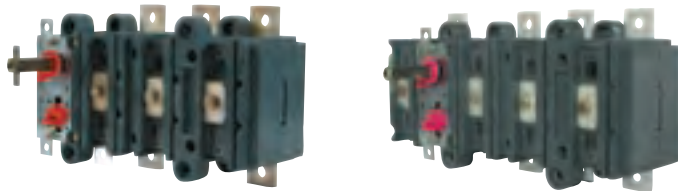

sezionamento visibile  
visible isolation

codici per ordini - ordering codes

INS\sv											big case
	63A	100A	125A	160A	200A	250A	315A	400A	630A	800A	1000A
3 pole	EINS00633200A	EINS01003200A	EINS01253200A	EINS01603200A	EINS02003200A	EINS02503200A	EINS03153200A	EINS04003200A	EINS06303200A	EINS08003200A	EINS10003200A
4 pole Note (5)	EINS00634201A	EINS01004201A	EINS01254201A	EINS01604201A	EINS02004201A	EINS02504201A	EINS03154201A	EINS04004201A	EINS06304201A	EINS08004201A	EINS10004201A
4 pole Note (1)	EINS00634202A	EINS01004202A	EINS01254202A	EINS01604202A	EINS02004202A	EINS02504202A	EINS03154202A	EINS04004202A	EINS06304202A	EINS08004202A	EINS10004202A
4 pole Note (6)	EINS00634203A	EINS01004203A	EINS01254203A	EINS01604203A	EINS02004203A	EINS02504203A	EINS03154203A	EINS04004203A	EINS06304203A	EINS08004203A	EINS10004203A
4 pole Note (2)	EINS00634204A	EINS01004204A	EINS01254204A	EINS01604204A	EINS02004204A	EINS02504204A	EINS03154204A	EINS04004204A	EINS06304204A	EINS08004204A	EINS10004204A
4 pole Note (3)	EINS00634207A	EINS01004207A	EINS01254207A	EINS01604207A	EINS02004207A	EINS02504207A	EINS03154207A	EINS04004207A	EINS06304207A	EINS08004207A	EINS10004207A
4 pole Note (7)	EINS00634207A	EINS01004209A	EINS01254209A	EINS01604209A	EINS02004209A	EINS02504209A	EINS03154209A	EINS04004209A	EINS06304209A	EINS08004209A	EINS10004209A



codici per ordini - ordering codes

INS											medium case	big case
	63A	100A	125A	160A	200A	250A	315A	400A	630A	630A	800A	1000A
6 pole	EINS00636000A	EINS01006000A	EINS01256000A	EINS01606000A	EINS02006000A	EINS02506000A	EINS03156000A	EINS04006000A	EINS06306000A	EINS06306100A	EINS08006000A	EINS10006000A
8 pole	EINS00638002A	EINS01008002A	EINS01258002A	EINS01608002A	EINS02008002A	EINS02508002A	EINS03158002A	EINS04008002A	EINS06308002A	EINS06308102A	EINS08008002A	EINS10008002A

Note (5) 4.to polo addossato sezionato  
4th leaning switched pole

Note (1) 4.to polo laterale sezionato  
4th side switched pole

Note (6) 4.to polo addossato passante non sezionabile  
4th leaning unswitched pole

Note (2) 4.to polo laterale passante non sezionabile  
4th side unswitched pole

Note (3) 4.to polo laterale passante sezionabile  
4th side switchable pole

Note (7) 4.to polo laterale sezionato, che porta con continuità una corrente doppia della nominale  
4th side switched pole, can carry the double of the rated current

Per vedere le fotografie dei neutri andare a pagina 42  
See page 42 for 4th pole photos

Per ordinare i sezionatori INS con manovra inversa (I-0) vedi pagina 42 nota D.  
See page 42 note D to order INS switches with anticlockwise operation (I-0)

nota: per gli ordini in Italia sostituire con la J la E iniziale nel codice prodotto

per le tabelle dimensionali e i disegni vedi pag.15-16  
see page 15-16 for dimensional tables and drawings



INS 63A÷1000A 3 poli  
 INS 63A÷1000A 4° polo addossato  
 INS 63A÷1000A 3 pole  
 INS 63A÷1000A 4<sup>th</sup> leaning pole

Picture 1

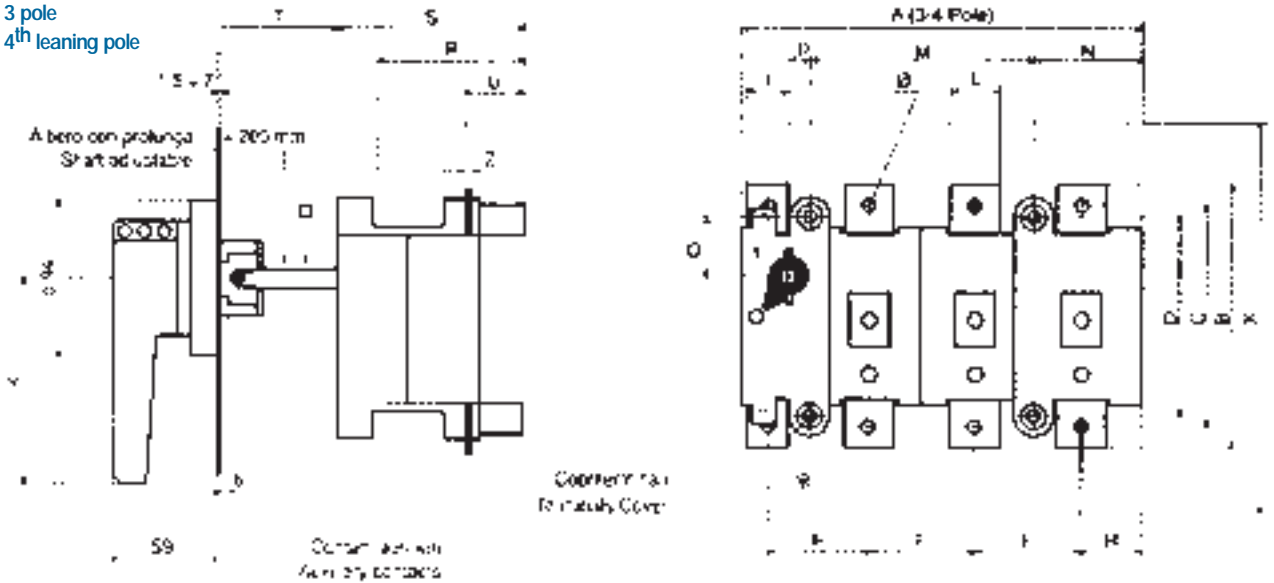

INS 63A÷1000A 4° polo laterale  
 INS 63A÷1000A 4<sup>th</sup> side pole

Picture 2

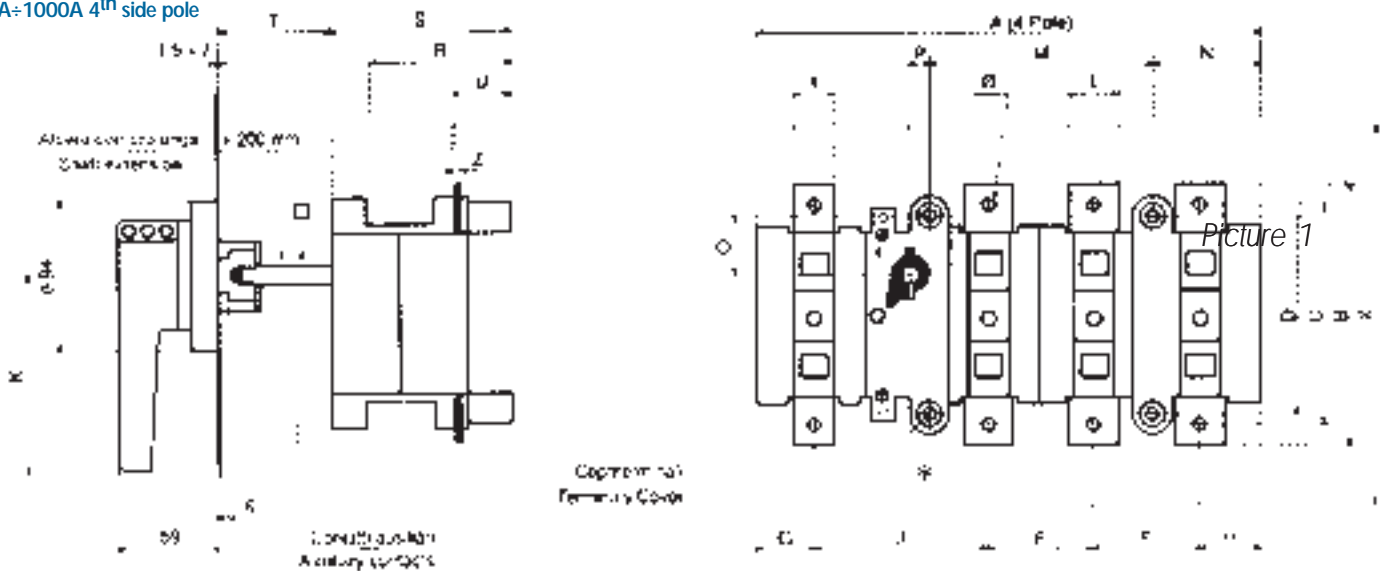

	A	A	B	C	Ø	D	F	G	H	I	I	J	K	L	M	N	O	P	R	S	T	U	Z	X	□	*
	3-4 pole	4 pole						picture 2		picture 1	picture 2	picture 2														
INS 63A																										
INS 100A																										
INS 125A	181	222	141	113	8,5	107	44	20	32	16	20	82	125	20	98	51	33	6	72	93	70	29	3	178	10	5,5
INS 160A																										
INS 200A																										
INS 250A			161	136	10,5						25			25												
INS 315A			161	136	10,5	119	65	25	42	25	30			30												
INS 400A	251	306	161	136	10,5						30	109	125	30	137	72	36	12	90	113	70	36	4	234	12	6,5
INS 630A note 1			187	156	10,5						35			35												
INS 630A note 2																							6			
INS 630A note 3																							6			
INS 800A	325	378	238	200	12,5	176	87	25	49	36	40	130	165	40	174	92	64	19,5	108	130	72	48	6	333	12	7
INS 1000A																							10			

note1 con copribarrette (in scatola media) - with link bar covers (in medium case)

note 2 con sezionamento visibile (in scatola grande) - with visible isolation (in big case) - note 3 con copribarrette (in scatola grande) - with link bar covers (in big case)

INS 63A÷1000A 6 poli  
 INS 63A÷1000A 8 poli  
 INS 63A÷1000A 6 pole  
 INS 63A÷1000A 8 pole

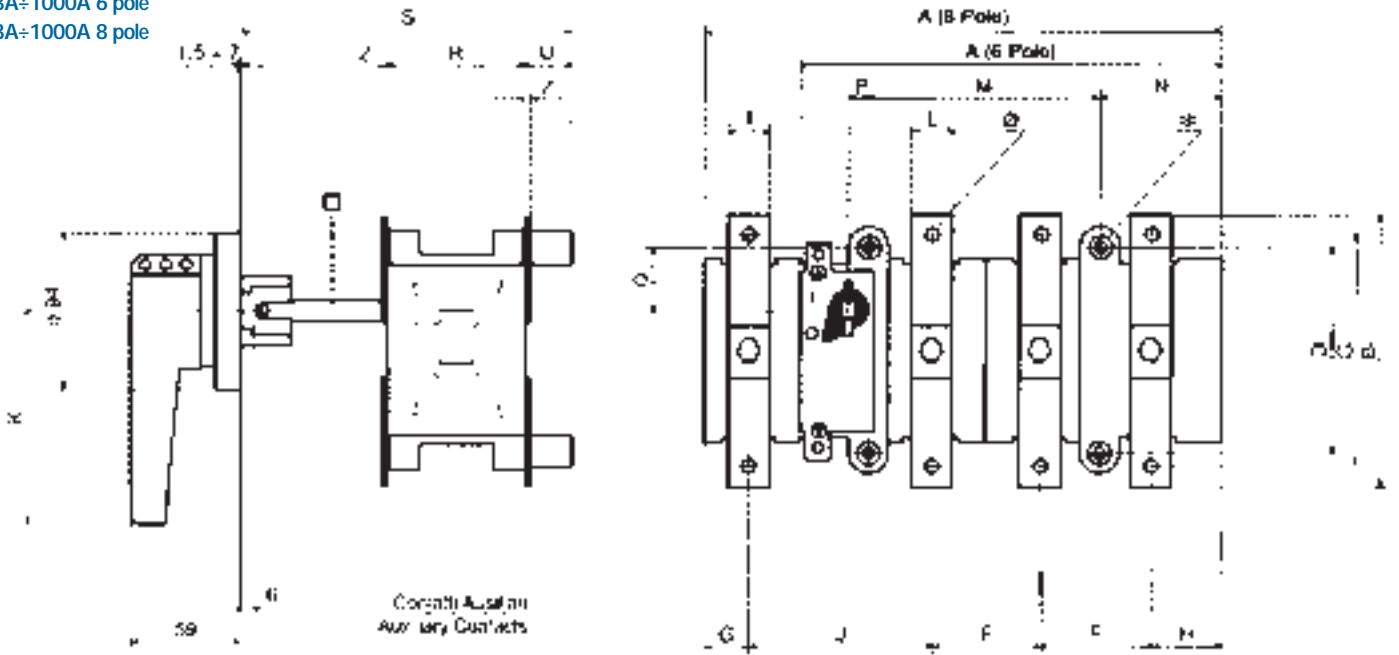

	A	A	B	C	Ø	D	F	G	H	I	J	K	L	M	N	O	P	R	S	U	Z	□	*
	6 pole	8 pole																					
INS 63A	181	222	141	113	8,5	107	44	20	32	20	82	125	20	98	51	33	6	57	163	29	3	10	5,5
INS 100A																							
INS 125A																							
INS 160A																							
INS 200A																							
INS 250A	251	306	161	136	10,5	119	65	25	42	109	125	25	137	72	36	12	67	183	36	4	12	6,5	
INS 315A			161	136								30											
INS 400A			161	136								30											
INS 630A note 1			187	156								35											
INS 630A note 2	325	378	238	200	12,5	176	87	25	49	40	130	165	40	174	92	64	19,5	77	202	48	6	12	7
INS 800A																					6		
INS 1000A																					10		

note1 scatola media - medium case

note 2 scatola grande - big case

caratteristiche tecniche - technical characteristics

**INP** (da pagina 18 a pagina 21 - from page 18 to page 21)

TIPO (SERIE) - TYPE (SERIES)	INP	INP	INP	INP	INP	INP	INP	INP	INP	INP	INP	INP	INP	INP	INP	INP	INP	INP	INP
CORRENTE NOMINALE A T.A. MAX 401° RATED THERMAL CURRENT AT 40° MAX A.T.	in aria libera free air	A	250	400	630	800	1000	1250	1600	1800	2000	2500	3150	4000	5000	6300	7000	INP	INP
	in cassetta box	A	250	350	630	720	910	1250	1600	1600	1800	2200	2500	3400	4200	5500	6000	INP	INP
NUMERO DEI POLI - NUMBER OF POLES	--	--	3-4	3-4	3-4	3-4	3-4	3-4	3-4	3-4	3-4	3-4	3-4	3-4	3-4	3-4	3-4	3-4	3-4
TENSIONE D'ISOLAMENTO - RATED VOLTAGE OF ISOLATION	U <sub>i</sub>	V	1000 600	1000 600	1000 600	1000 600	1000 600	1000 600	1000 600	1000 600	1000 600	1000 600	1000 600	1000 600	1000 600	1000 600	1000 600	1000 600	1000 600
TENSIONE DI TENUTA AD IMPULSO - IMPULSE WITHSTAND VOLTAGE	--	kV	8	8	8	8	8	8	8	8	8	8	8	8	8	8	8	8	8
CORRENTE D'IMPIEGO - OPERATIONAL CURRENT AC21	I <sub>e</sub>	A	250	400	630	800	1000	1250	1600	1800	2000	2500	3150	4000	5000	6300	7000	INP	INP
CORRENTE D'IMPIEGO - OPERATIONAL CURRENT AC22	I <sub>e</sub>	A	250	400	630	800	1000	1250	1600	1600	1600	2000	2100	2200	2500	2600	2600	INP	INP
CORRENTE D'IMPIEGO - OPERATIONAL CURRENT AC23	I <sub>e</sub>	A	250	400	630	630	800	--	--	--	--	--	--	--	--	--	--	INP	INP
POTENZA REATTIVA - REACTIVE POWER note (1)	--	kVAr	125	200	280	300	320	400	500	--	--	--	--	--	--	--	--	INP	INP
CORRENTE DI BREVE DURATA RATED SHORT-TIME WITHSTAND CURRENT	I <sub>cw</sub>	kA r.m.s.	19	21	32	36	40	40	50	55	60	80	85	100	120	120	120	INP	INP
POTERE DI CHIUSURA IN C.TO C. TO RATED SHORT-CIRCUIT MAKING CAPACITY	I <sub>cm</sub>	kA peak	40	45	67	76	84	84	105	121	132	176	187	200	200	200	200	INP	INP
DURATA MECCANICA - MECHANICAL ENDURANCE	--	n°	8000	5000	5000	3000	3000	3000	3000	3000	3000	3000	2000	2000	2000	2000	2000	2000	2000
VITA ELETTRICA - ELECTRICAL LIFE	--	n°	1000	1000	1000	500	500	500	500	500	500	500	500	500	500	500	500	500	500
PESO - WEIGHT INP 3 pole	--	Kg	3	3,2	5,2	6,3	6,3	12,5	13,5	17,5	17,5	45	45	82,5	82,5	82,5	92,5	INP	INP
PESO - WEIGHT INP 4 pole - 4° polo addossato - 4th leaning pole	--	Kg	3,1	--	5,5	--	--	--	--	--	--	--	--	--	--	--	--	INP	INP
PESO - WEIGHT INP 4 pole - 4° polo laterale - 4th side pole	--	Kg	3,8	4	6	7,3	7,3	14,5	17	22	22	54	54	110	110	110	120	INP	INP

note (1) a causa delle armoniche e delle tolleranze dei condensatori, i valori nominali devono essere ridotti del 33% - due to harmonics and tolerance of the capacitors, the rated values have been reduced by 33%

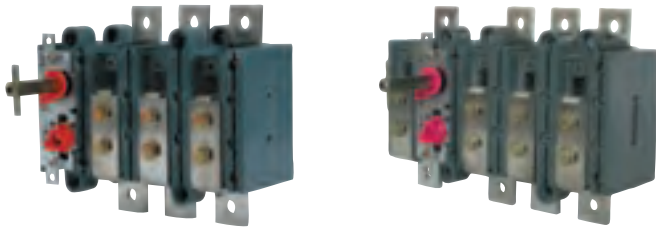

codici per ordini - ordering codes

INP	250A	400A	630A	800A	1000A	1250A	1600A	1800A	2000A
3 pole	EINP02503300A	EINP04003300A	EINP06303300A	EINP08003300A	EINP10003300A	EINP12503300A	EINP16003300A	EINP18003300A	EINP20003300A
4 pole Note (5)	EINP02504301A	-	EINP06304301A	-	-	-	-	-	-
4 pole Note (1)	EINP02504302A	EINP04004302A	EINP06304302A	EINP08004302A	EINP10004302A	EINP12504302A	EINP16004302A	EINP18004302A	EINP20004302A
4 pole Note (6)	EINP02504303A	-	EINP06304303A	-	-	-	-	-	-
4 pole Note (2)	EINP02504304A	EINP04004304A	EINP06304304A	EINP08004304A	EINP10004304A	EINP12504304A	EINP16004304A	EINP18004304A	EINP20004304A
4 pole Note (3)	EINP02504307A	EINP04004307A	EINP06304307A	EINP08004307A	EINP10004307A	EINP12504307A	EINP16004307A	EINP18004307A	EINP20004307A

Note (5) 4.to polo addossato sezionato  
4th leaning switched pole

Note (6) 4.to polo addossato passante non sezionabile  
4th leaning unswitched pole

Note (3) 4.to polo laterale passante sezionabile  
4th side switchable pole

Note (1) 4.to polo laterale sezionato  
4th side switched pole

Note (2) 4.to polo laterale passante non sezionabile  
4th side unswitched pole

Per vedere le fotografie dei neutri andare a pagina 48  
See page 48 for 4<sup>th</sup> pole photos

- INP 250A÷2000A 3 poli
- INP 250A÷2000A 4° polo addossato
- INP 250A÷2000A 3 pole
- INP 250A÷2000A with 4<sup>th</sup> leaning pole

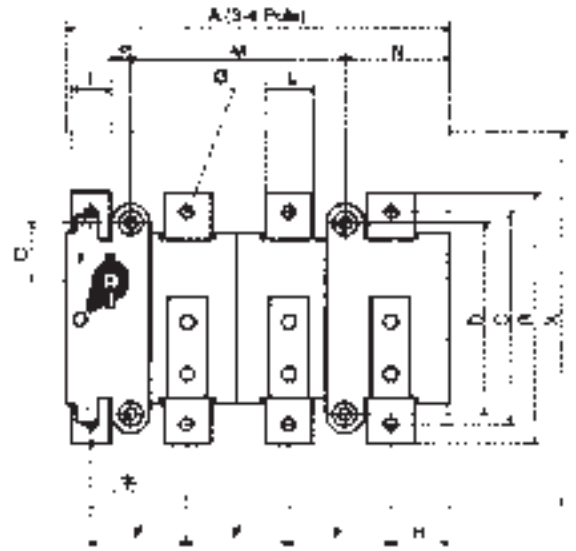
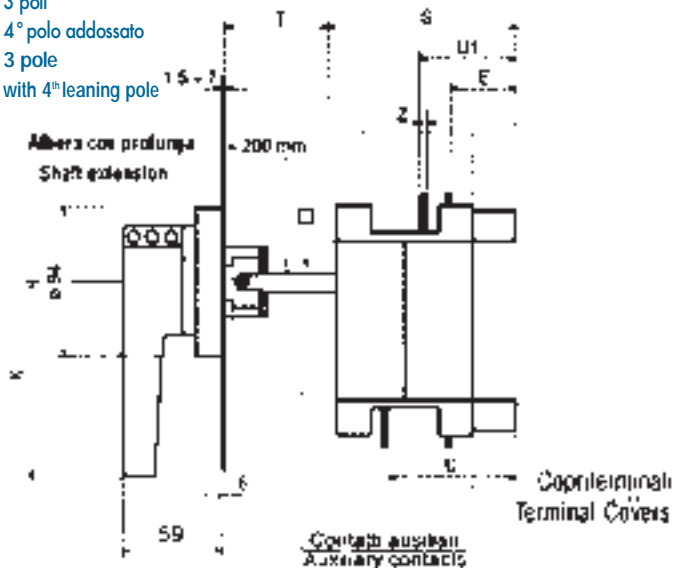

	A	A	B	C	C <sub>1</sub>	D	E	F	H	I	K	L	M	N	O	P	S	T	U	U <sub>1</sub>	Z	X	□	Ø	*
	3-4 pole	4 pole																							
INP 250A	181	181	153	128	-	107	29	44	32	16	125	25	98	51	33	6	98	60	57	45	4	178	10	10,5	5,5
INP 400A	181	-					5																		
INP 630A	256	256	200	167	-	119	37	65	42	25	125	30	137	72	36	12	115	70	70	50	5	234	12	12,5	6,5
INP 800A	256	-					10																		
INP 1000A		-					10																		
INP 1250A	325	-	353	317	267	176	-	87	49	40	165	40	174	92	64	19,5	150	118	80	90	10	333	12	12,5	7
INP 1600A			79	91	12																				
INP 1800A			75	95	20																				
INP 2000A					20																				

Per ordinare i sezionatori INP con manovra inversa (I-0) vedi pagina 42 nota D.  
See page 42 note D to order INP switches with anticlockwise operation (I-0)

nota: per gli ordini in Italia sostituire con la J la E iniziale nel codice prodotto

altre tabelle dimensionali e disegni a pag. 19  
see page 19 for other dimensional tables and drawings



INP 250A÷2000A 4° polo laterale  
 INP 250A÷2000A with 4<sup>th</sup> side pole

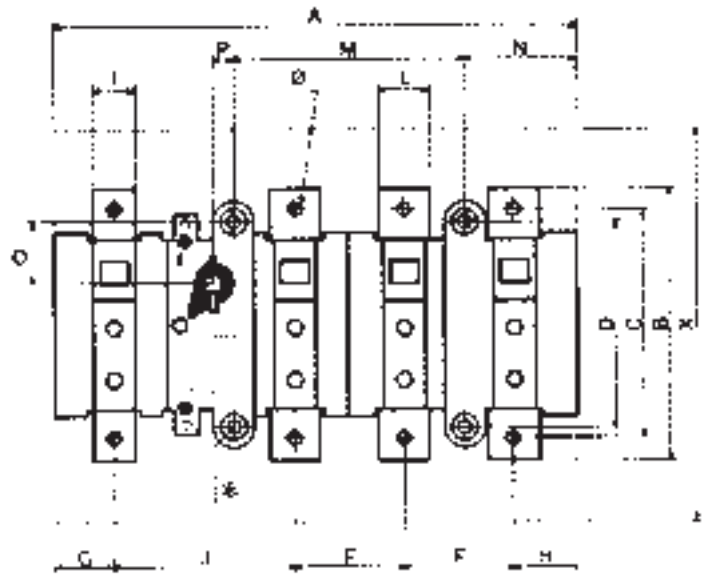
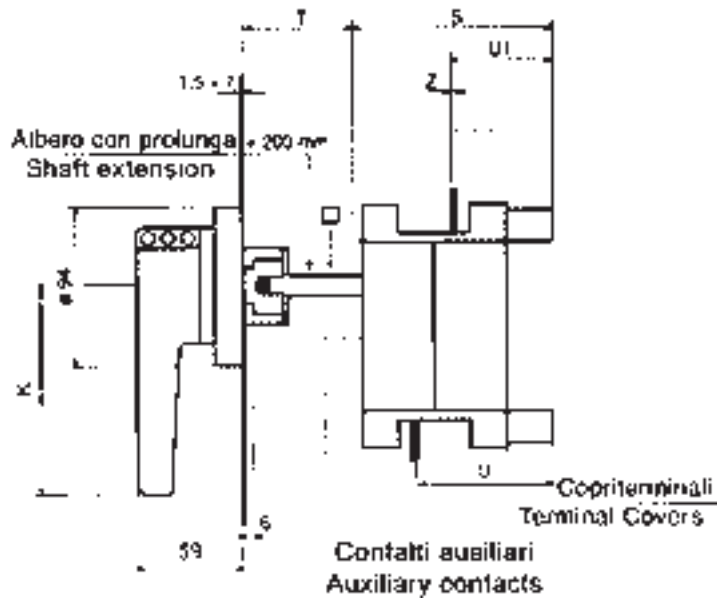

	A	B	C	Ø	D	F	H	G	I	J	K	L	M	N	O	P	S	T	U	U <sub>1</sub>	Z	X	□	*
INP 250A	222	153	128	10,5	107	44	32	20	25	82	125	25	98	51	33	6	98	60	57	45	4	178	10	5,5
INP 400A																					5			
INP 630A	306	200	167	12,5	119	65	42	25	30	109	125	30	137	72	36	12	115	70	70	50	5	234	12	6,5
INP 800A																					10			
INP 1000A																					10			
INP 1250A	378	353	316	12,5	176	87	49	25	40	130	165	40	174	92	64	19,5	150	118	80	90	10	334	12	7
INP 1600A																			79	91	12			
INP 1800A																			20					
INP 2000A																			75	95	20			

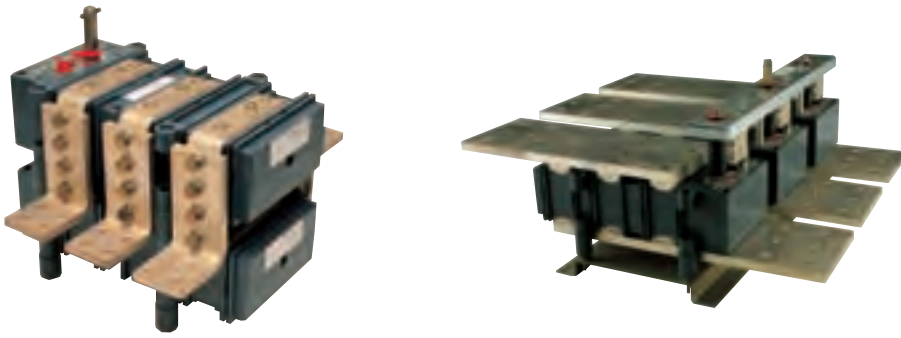

codici per ordini - ordering codes

INP	2500A	3150A	4000A	5000A	6300A	7000A
3 pole	EINP25003000A	EINP31503000A	EINP40003000A	EINP50003000A	EINP63003000A	EINP70003000A
4 pole	EINP25004002A	EINP31504002A	EINP40004002A	EINP50004002A	EINP63004002A	EINP70003000A

INP 2500A÷4000A 3-4 poli  
INP 2500A÷4000A 3-4 pole

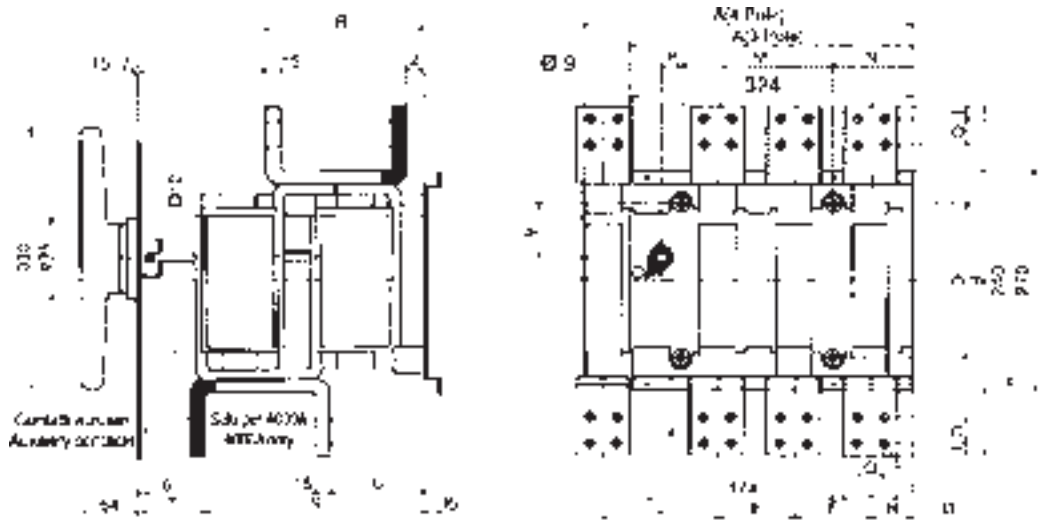

	A	A	B	D	F	H	J	I	L	M	N	O	P	Q	R	S	T	U	V	*	Ø	Z
	3 pole	4 pole																				
INP 2500A																						
INP 3150A	324	377	440	176	107	29	110	20	80	174	92	64	19,5	40	176	262	143	120	64	7	12,5	40
INP 4000A																						

INP 5000A÷6300A 3-4 poli  
INP 5000A÷6300A 3-4 pole

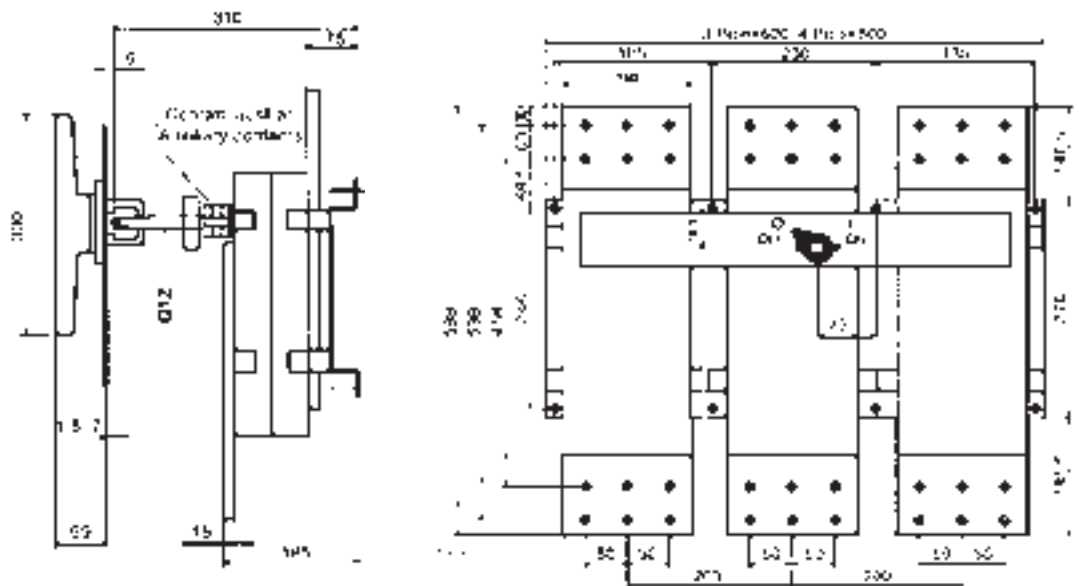

Per ordinare i sezionatori INP con manovra inversa (I-0) vedi pagina 42 nota D.  
See page 42 note D to order INP switches with anticlockwise operation (I-0)

nota: per gli ordini in Italia sostituire con la J la E iniziale nel codice prodotto

INP 7000A 3-4 poli  
 INP 7000A 3-4 pole

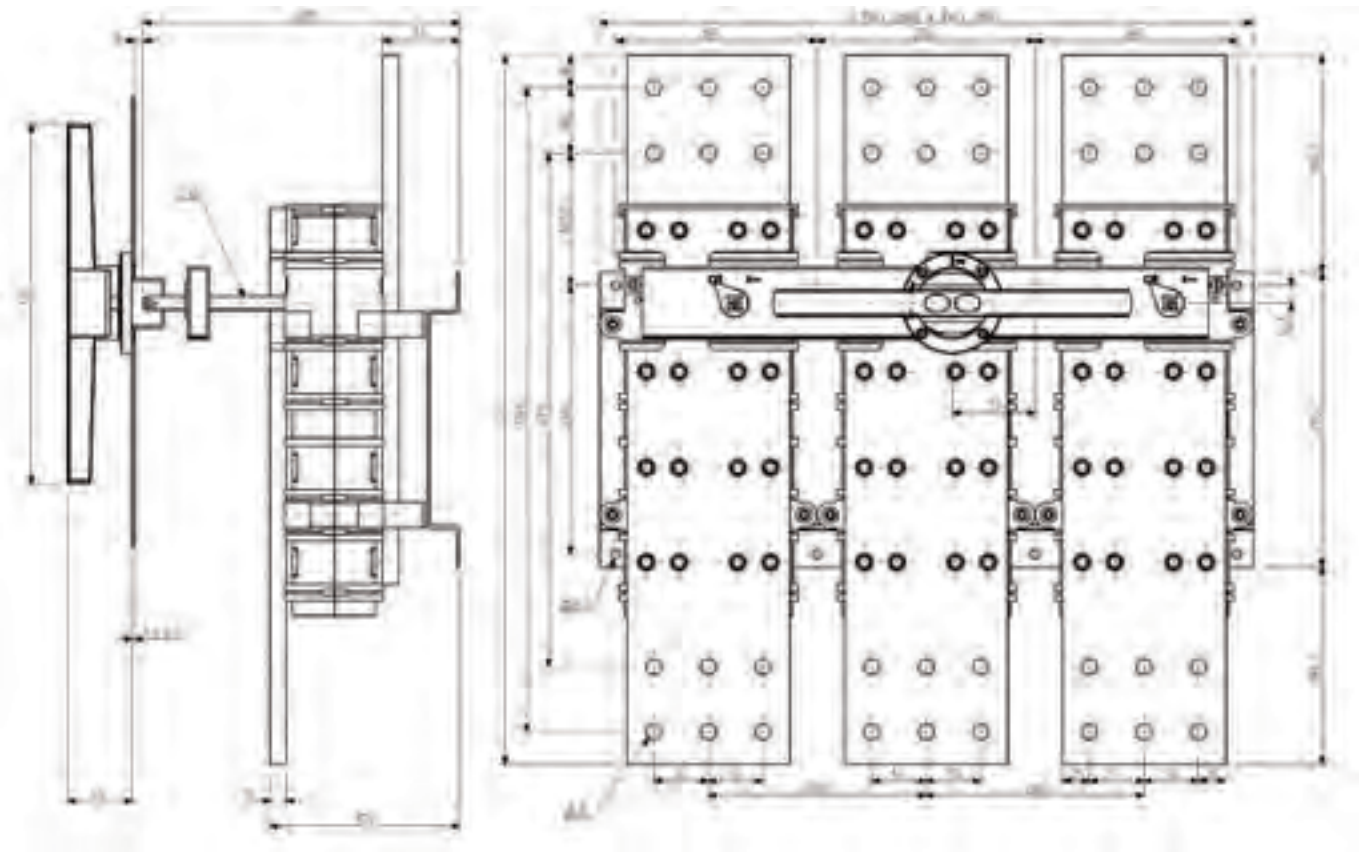

# INTERRUTTORI DI MANOVRA-SEZIONATORI MOTORIZZATI

## MOTOR DRIVEN SWITCH-DISCONNECTORS

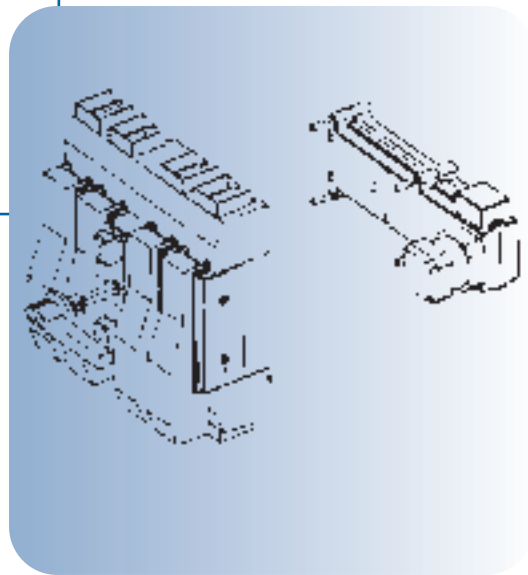

**GENERALITÀ**

Gli interruttori di manovra-sezionatori motorizzati, IMV e gli interruttori di manovra-sezionatori con fusibili motorizzati, IMF sono apparecchi provvisti di dispositivo elettro-meccanico per il comando a distanza.

**CARATTERISTICHE COSTRUTTIVE**

Gli apparecchi motorizzati IMV e IMF hanno le seguenti caratteristiche:

- a) dimensioni compatte;
- b) dispositivo di comando frontale;
- c) il sezionamento;
- d) nel caso di mancanza della tensione ausiliaria la possibilità di continuare la manovra con il dispositivo manuale.

**NORME DI RIFERIMENTO**

Gli interruttori di manovra-sezionatori motorizzati, IMV e gli interruttori di manovra-sezionatori con fusibili motorizzati, IMF sono costruiti in conformità alle seguenti Norme:

**CEI EN 60947-3**

**GENERAL**

The IMV motor-driven switch-disconnectors and IMF motor-driven switch-disconnector-fuses are provided with a special electro-mechanical device suitable for remote operation.

**MANUFACTURING DETAILS**

The IMV motor-driven switch-disconnectors and IMF motor-driven switch-disconnector-fuses have the following characteristics:

- a) compact dimensions;
- b) frontal operating mechanism;
- c) safety isolation;
- d) possibility to complete manually, through handle, the operation in case of auxiliary supply voltage lack.

**REFERENCE STANDARDS**

The IMV motor-driven switch-disconnectors and IMF motor-driven switch-disconnector-fuses are manufactured in compliance with the following Standards:

**IEC 60947-3**

**SCHEMA TIPO PER IMV  
 CONTROL SCHEME FOR IMV**

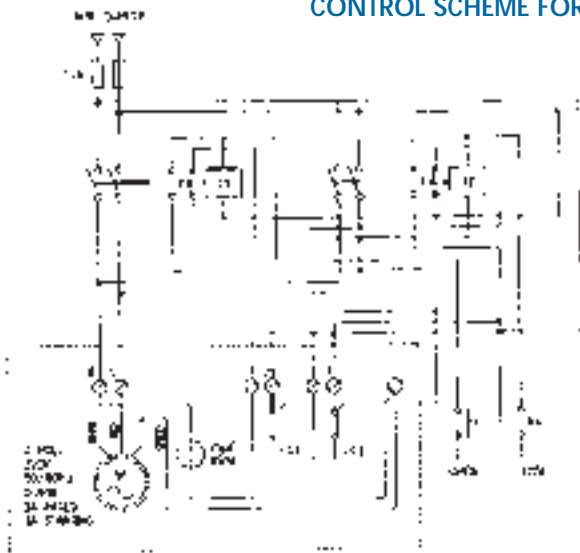

**SCHEMA TIPO PER IMF  
 CONTROL SCHEME FOR IMF**

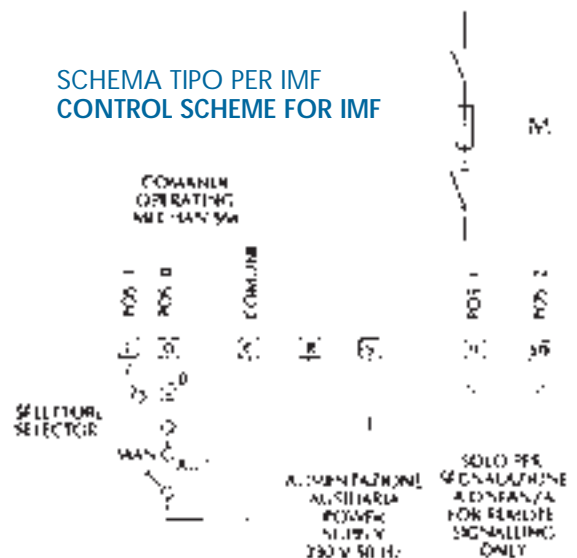

**SCHEDA ELETTRONICA - ELECTRONIC CARD**

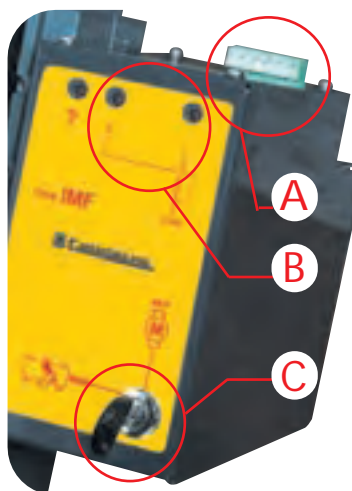

CARATTERISTICHE E VANTAGGI	CHARACTERISTICS AND ADVANTAGES	ACCESSORI STANDARD	STANDARD ACCESSORIES
i relé e i cablaggi non sono più necessari	relays and relevant wiring are not necessary	n° 2 LED di segnalazione posizioni (0-I)	n° 2 position signalling (0-I) LEDs
protezione contro le anomalie	protection against incorrect operations	n° 1 LED di segnalazione delle anomalie	n° 1 abnormal condition signalling LED (?)
impossibilità di effettuare manovre elettriche in condizioni anomale	the motor driven operations are prevented during abnormal conditions	n° 1 selettore con chiave manuale-elettrico	n° 1 manual-automatic selector key
segnalazione delle anomalie	abnormal conditions signalling through LED	n° 2 morsetti per segnalazione a distanza	n° 2 available terminals for remote signalling
selettore con chiave manuale-elettrico	the manual - automatic selector key is already included in the supply		
il cliente finale deve solo cablare la morsettiera	the final customer has only to wire the terminal block		

A	B	C
Morsettiera Terminal Block	Led di segnalazione signalling LEDs	Selettore con chiave comando manuale - elettrico manual-automatic key selector



caratteristiche tecniche - technical characteristics

IMV (da pagina 25 a pagina 27 - from page 25 to page 27)

TIPO (SERIE) - TYPE (SERIES)	--	IMV	IMV	IMV	IMV	IMV	IMV	IMV	IMV	IMV	IMV	IMV	IMV	IMV	IMV	IMV	IMV	IMV			
CORRENTE NOMINALE A T.A. MAX 401° RATED THERMAL CURRENT AT 40° MAX A.T.	in aria libera free air	A	125	160	200	250	315	400	630	800	1000	1250	1600	1800	2000	2500	3150	4000	5000	6300	7000
	in cassetta box	A	125	150	160	200	300	340	550	630	800	1250	1600	1600	1800	2200	2500	3400	4200	5500	6000
NUMERO DEI POLI - NUMBER OF POLES	--	3-4-6-8	3-4-6-8	3-4-6-8	3-4-6-8	3-4-6-8	3-4-6-8	3-4-6-8	3-4-6-8	3-4-6-8	3-4-6-8	3-4	3-4	3-4	3-4	3-4	3-4	3-4	3-4	3-4	3-4
TENSIONE D'ISOLAMENTO - RATED VOLTAGE OF ISOLATION	U <sub>i</sub> c.a./a.c. c.c./d.c.	V	1000 660	1000 660	1000 660	1000 660	1000 660	1000 660	1000 660	1000 660	1000 660	1000 660	1000 660	1000 660	1000 660	1000 660	1000 660	1000 660	1000 660	1000 660	1000 660
TENSIONE DI TENUTA AD IMPULSO - IMPULSE WITHSTAND VOLTAGE	--	KV	8	8	8	8	8	8	8	8	8	8	8	8	8	8	8	8	8	8	8
CORRENTE D'IMPIEGO - OPERATIONAL CURRENT AC21	I <sub>e</sub> 500 V	A	125	160	200	250	315	400	630	800	1000	1250	1600	1800	2000	2500	3150	4000	5000	6300	7000
CORRENTE D'IMPIEGO - OPERATIONAL CURRENT AC22	I <sub>e</sub> 500 V	A	125	160	200	250	315	400	630	800	1000	1250	1600	1600	2000	2000	2100	2200	2500	2600	2600
CORRENTE D'IMPIEGO - OPERATIONAL CURRENT AC23	I <sub>e</sub> 500 V	A	125	160	200	250	315	400	630	800	1000	--	--	--	--	--	--	--	--	--	--
POTENZA REATTIVA - REACTIVE POWER note (1)	380 V	KVAR	60	75	100	125	150	200	280	300	320	400	500	--	--	--	--	--	--	--	--
CORRENTE DI BREVE DURATA RATED SHORT-TIME WITHSTAND CURRENT	I <sub>cm</sub> 1 sec	KA r.m.s.	8	10	10	12,5	15	18	20	25	35	40	55	80	85	100	120	120	120	120	120
POTERE DI CHIUSURA IN C.T.O C. TO RATED SHORT-CIRCUIT MAKING CAPACITY	I <sub>cm</sub> 500 V	KA peak	20	25	25	31	37	44	50	63	74	84	121	121	132	176	187	200	200	200	200
DURATA MECCANICA - MECHANICAL ENDURANCE	operazioni operations	n°	8000	8000	8000	8000	8000	5000	5000	3000	3000	3000	3000	3000	3000	2000	2000	2000	2000	2000	2000
VITA ELETTRICA - ELECTRICAL LIFE	operazioni operations	n°	1000	1000	1000	1000	1000	1000	1000	500	500	500	500	500	500	500	500	500	500	500	500
TEMPI DI MANOVRA O-1 - OPERATING TIME O-1	--	(sec)	5	5	5	5	5	5	5	5	5	5	5	5	5	5	5	5	5	5	5
PESO - WEIGHT IMV 3 poli note (A) page 0 contatti in serie - contacts in series	--	Kg	9,6	9,6	9,6	11,8	11,9	11,9	12,3	18,5	19,6	--	--	--	--	--	--	--	--	--	--
PESO - WEIGHT IMV 4 poli note (A) page 0 contatti in serie - contacts in series	--	Kg	9,9	9,9	9,9	12,3	12,5	12,5	13,3	20	21,5	--	--	--	--	--	--	--	--	--	--
PESO - WEIGHT IMV 6 poli note (A) page 0 contatti in serie - contacts in series	--	Kg	9,6	9,6	9,6	11,8	11,9	11,9	12	18,6	19,4	--	--	--	--	--	--	--	--	--	--
PESO - WEIGHT IMV 8 poli note (A) page 0 contatti in serie - contacts in series	--	Kg	10	10	10	12,6	12,7	12,7	13	20,6	21,5	--	--	--	--	--	--	--	--	--	--
PESO - WEIGHT IMV 3 poli note (B) page 0 c.t.i in parallelo - contacts in parallel	--	Kg	--	--	--	9,9	10,1	10,1	12,4	13,5	13,5	21,5	22,5	26,5	54	54	54,6	101,2	101,2	101,2	112
PESO - WEIGHT IMV 4 poli note (B) page 0 c.t.i in parallelo - contacts in parallel	--	Kg	--	--	--	10,7	10,9	10,9	13,2	14,5	14,5	23,5	26	31	63	63	63,8	131,9	131,9	131,9	142

note (1) a causa delle armoniche e delle tolleranze dei condensatori, i valori nominali devono essere ridotti del 33% - due to harmonics and tolerance of the capacitors, the rated values have been reduced by 33%



da 220V a 240V  
corrente alternata 50/60 Hz  
from 220V to 240V  
alternating current 50/60 Hz

Per ordinare il 24V a corrente continua sostituire la lettera finale **A** del codice del prodotto IMV 220V-240V con la lettera **H**. Esempio EIMV01253000**A** diventa EIMV01253000**H**  
To order 24V direct current replace the letter **A** of IMV 220V-240V ordering code with letter **H**. Example: EIMV01253000**A** becomes EIMV01253000**H**

codici per ordini - ordering codes

IMV	125A	160A	200A	250A	315A	400A	630A	800A
3 pole	EIMV01253000A	EIMV01603000A	EIMV02003000A	EIMV02503000A	EIMV03153000A	EIMV04003000A	EIMV06303000A	EIMV08003000A
4 pole	EIMV01254002A	EIMV01604002A	EIMV02004002A	EIMV02504002A	EIMV03154002A	EIMV04004002A	EIMV06304002A	EIMV08004002A
6 pole	EIMV01256000A	EIMV01606000A	EIMV02006000A	EIMV02506000A	EIMV03156000A	EIMV04006000A	EIMV06306000A	EIMV08006000A
8 pole	EIMV01258002A	EIMV01608002A	EIMV02008002A	EIMV02508002A	EIMV03158002A	EIMV04008002A	EIMV06308002A	EIMV08008002A

IMV	1000A	1250A	1600A	1800A	2000A	2500A	3150A	4000A
3 pole	EIMV10003000A	EIMV12503000A	EIMV16003000A	EIMV18003000A	EIMV20003000A	EIMV25003000A	EIMV31503000A	EIMV40003000A
4 pole	EIMV10004002A	EIMV12504002A	EIMV16004002A	EIMV18004002A	EIMV20004002A	EIMV25004002A	EIMV31504002A	EIMV40004002A
6 pole	EIMV10006000A	-	-	-	-	-	-	-
8 pole	EIMV10008002A	-	-	-	-	-	-	-

IMV	5000A	6300A	7000A
3 pole	EIMV50003000A	EIMV63003000A	EIMV70003000A
4 pole	EIMV50004002A	EIMV63004002A	EIMV70004002A

Per ordinare l'interruttore motorizzato con scheda elettronica sostituire la lettera finale **A** del codice del prodotto IMV 220V-240V con la lettera **S**. Esempio EIMV01253000**A** diventa EIMV01253000**S**  
To order motor driver switch with electronic card replace the letter **A** of IMV 220V-240V ordering code with letter **S**. Example: EIMV01253000**A** becomes EIMV01253000**S**

Per ordinare l'interruttore motorizzato con scheda elettronica sostituire la lettera finale **A** del codice del prodotto IMV 24V con la lettera **T**. Esempio EIMV01253000**A** diventa EIMV01253000**T**  
To order motor driver switch with electronic card replace the letter **A** of IMV 24V ordering code with letter **T**. Example: EIMV01253000**A** becomes EIMV01253000**T**

IMV 125A÷2000A 3-4 poli  
IMV 125A÷2000A 3-4 pole

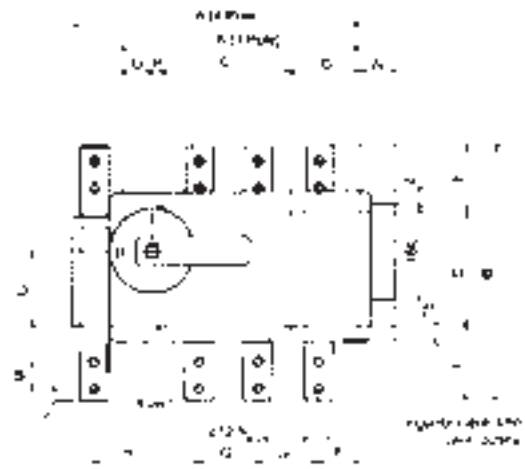
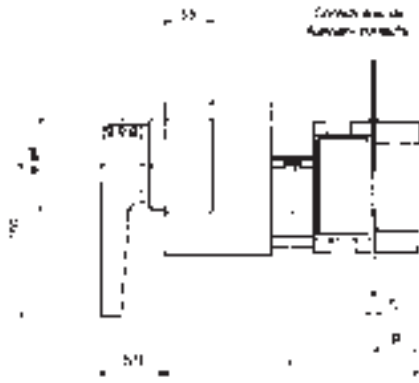

	A	A	B	C	D	E	F	G	H	I	L	M	N	O	P	Q	R	S	U	V	Z
	3 pole	4 pole																			
IMV 125A	181	222	133	98	107	13	32	44	82	20	10	-	35	51	6	26	26	3	74	305	20
IMV 160A																					
IMV 200A																					
IMV 250A			161			21				25							44	4			
IMV 400A				137	119		42	65	109		15		36	72	12	35	44	5			
IMV 630A	256	306															44	5			
IMV 800A			197			39				30							39	10			
IMV 1000A																	45	8			
IMV 1250A																	45	10			
IMV 1600A	325	378	352	174	176	73	49	87	130	40	20	30	50	92	19,5	56	43	16	112	330	45
IMV 1800A																	39	20			
IMV 2000A																	35	20			

nota: per gli ordini in Italia sostituire con la J la E iniziale nel codice prodotto

per le tabelle dimensionali e i disegni vedi pag. 26-27  
see page 26-27 for dimensional tables and drawings

IMV 2500A÷6300A 3-4 poli  
 IMV 2500A÷6300A 3-4 pole

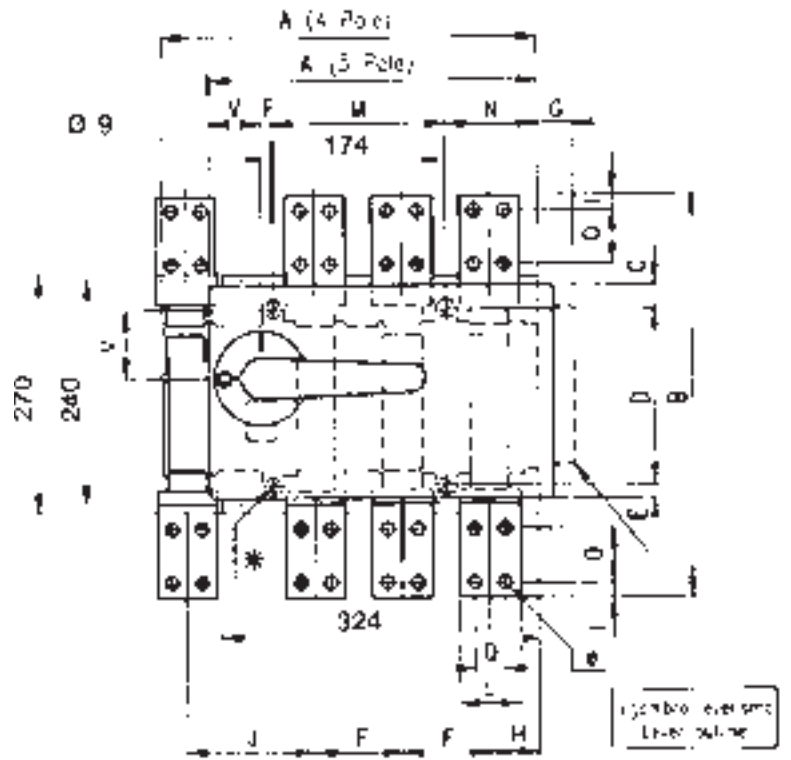
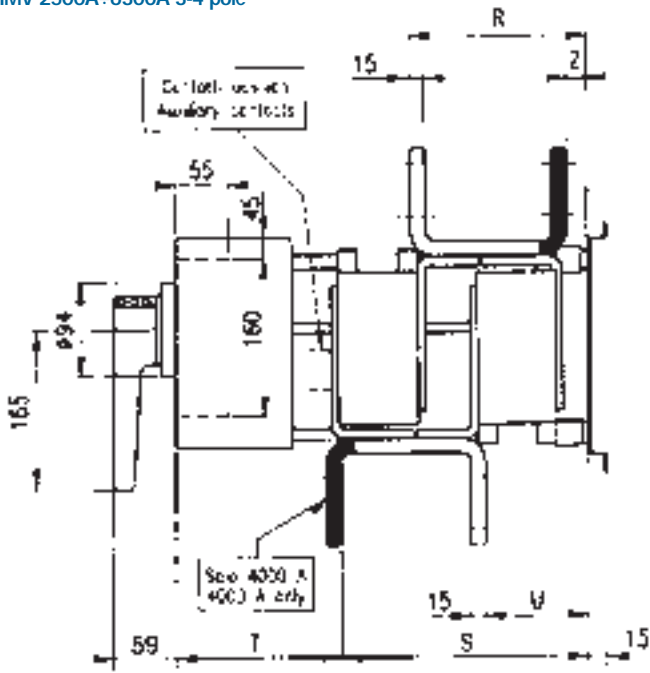

	A	A	B	C	D	E	F	G	H	J	I	L	M	N	O	P	Q	R	S	T	U	V	Z	*	Ø
	3 pole	4 pole																							
IMV 2500A																									
IMV 3150A	324	377	440	63	176	22	107	27	29	110	20	80	174	92	40	19,5	40	176	262	190	120	64	40	7	12,5
IMV 4000A																									

IMV 5000A÷6300A 3-4 poli  
 IMV 5000A÷6300A 3-4 pole

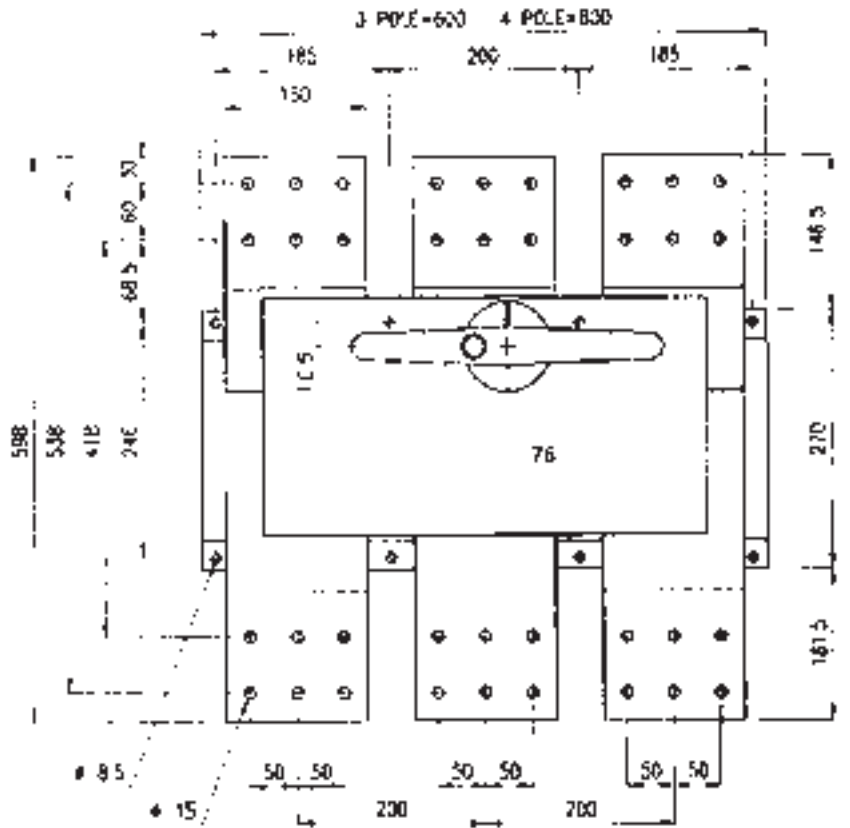
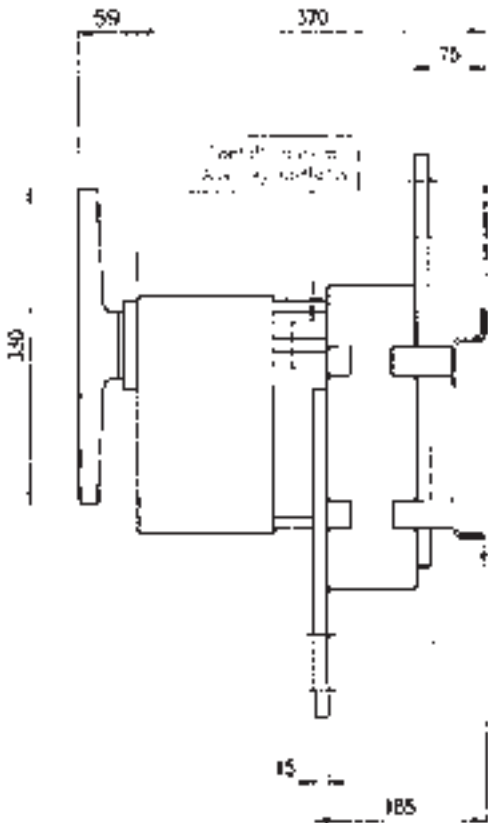

IMV 7000A 3-4 poli  
 IMV 7000A 3-4 pole

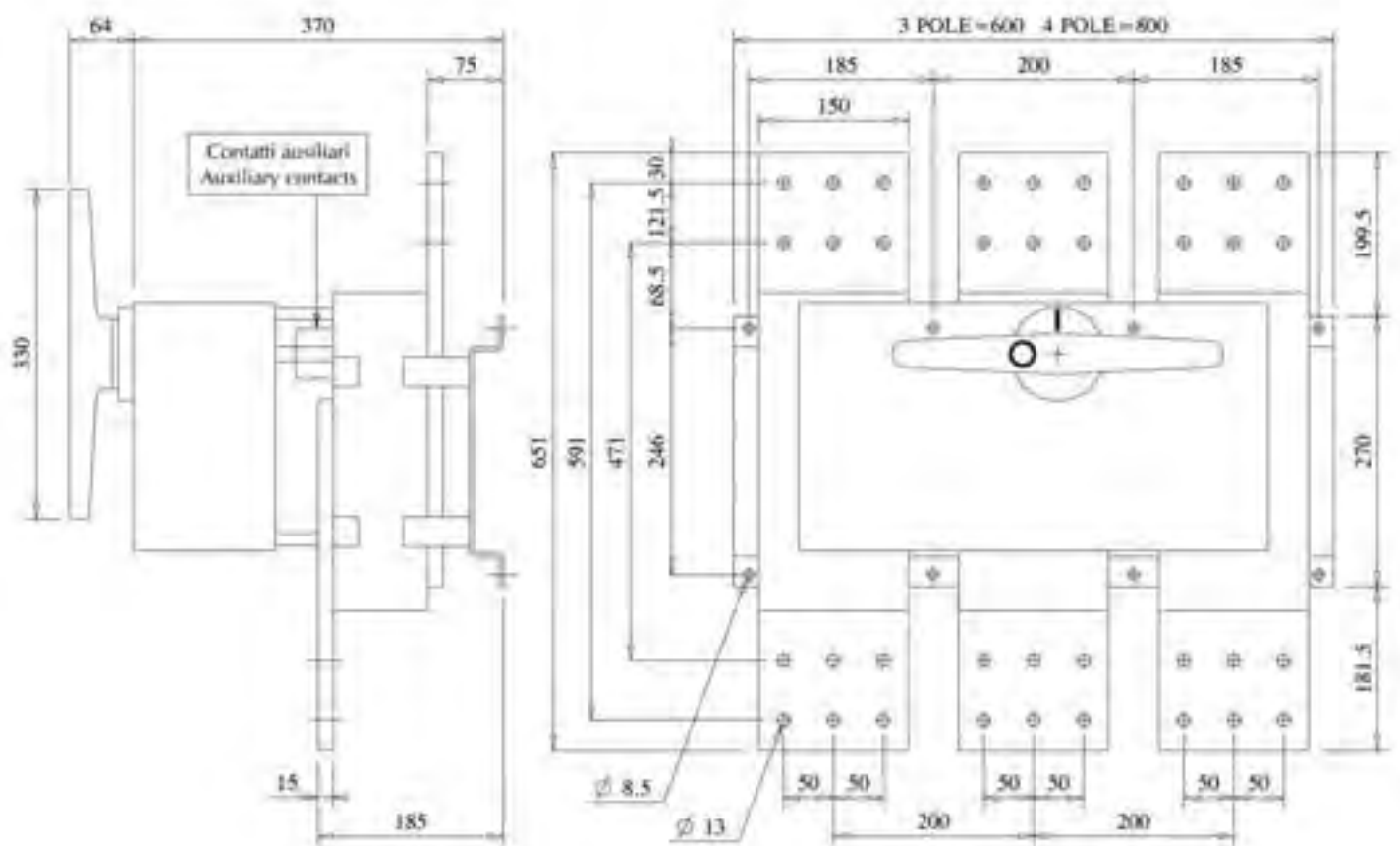

TIPO (SERIE) - TYPE (SERIES)	--	IMF	IMF	IMF	IMF	IMF	IMF	IMF	IMF	IMF	IMF	IMF	IMF	IMF	IMF	IMF	
<b>I<sub>th</sub></b> CORRENTE NOMINALE A T.A. MAX 40° RATED THERMAL CURRENT AT 40° MAX A.T.	in aria libera free air	A	125	160	200	250	315	400	630	800	1000	1250					
	in cassetta box	A	110	150	160	200	300	340	550	630	700	900					
<b>U<sub>i</sub></b> TENSIONE D'ISOLAMENTO - RATED VOLTAGE OF ISOLATION	--	--	3-4	3-4	3-4	3-4	3-4	3-4	3-4	3-4	3-4	3-4					
	c.a./a.c. c.c./d.c.	V	1000 660	1000 660	1000 660	1000 660	1000 660	1000 660	1000 660	1000 660	1000 660	1000 660					
TENSIONE DI TENUTA AD IMPULSO - IMPULSE WITHSTAND VOLTAGE	--	KV	8	8	8	8	8	8	8	8	8	8					
<b>I<sub>e</sub></b> CORRENTE D'IMPIEGO - OPERATIONAL CURRENT AC23A	415 V	A/KW	125/55	160/75	200/105	250/132	315/155	400/200	630/355	800/400	1000/500	1250/600					
	500 V		125/75	160/100	200/125	250/160	315/200	400/280	630/425	800/560	1000/670	1250/670					
	690 V		125/90	160/140	200/175	250/220	315/275	400/375	630/560	800/710	1000/710	1250/710					
<b>I<sub>e</sub></b> CORRENTE D'IMPIEGO - OPERATIONAL CURRENT AC22A	690 V	A	125	160	200	250	315	400	630	800	1000	1250					
	1000 V																
<b>I<sub>e</sub></b> CORRENTE D'IMPIEGO - OPERATIONAL CURRENT DC23A note (G) pag. 48	220 V	A	125	160	200	250	315	400	630	800	1000	1250					
	440 V		125	160	200	250	315	400	630	800	1000	1250					
	600 V		125	160	200	250	315	400	630	800	1000	1250					
POTENZA REATTIVA - REACTIVE POWER note (1)	380 V	KVAR	60	75	100	125	150	250	315	350	400						
POTERE DI CHIUSURA CONDIZIONATO DA FUSIBILE RATED SHORT-CIRCUIT MAKING CAPACITY	690 V	kA peak	100	100	100	100	100	100	100	100	100						
DURATA MECCANICA - MECHANICAL ENDURANCE	operazioni - operations	n°	8000	8000	8000	8000	8000	5000	5000	3000	3000						
VITA ELETTRICA - ELECTRICAL LIFE	operazioni - operations	n°	1000	1000	1000	1000	1000	1000	1000	500	500						
TEMPI DI MANOVRA O-I - OPERATING TIME O-I	--	(sec)	3	3	3	3	3	3	3	3	3						
FUSIBILI - FUSE TYPE	DIN 43620		00-0	00-0	--	1-2	--	1-2	3	4	4						
	NFC 62210		22x58	--	--	--	--	--	--	--	--						
BS 88			A4	B1-B2	B1-B3	B1-B3	B2-B3	B1-B4	C1-C2	C3-D1	D1	D1					
			W	4,8	6,6	11	12	19	28	40	41	64					
POTENZA DISSIPATA PER POLO - POWER LOSS FOR POLE			4,8	6,6	11	12	19	28	40	41	64						
PESO - WEIGHT MF 3 pole 24V dc: note (2) and 220V-240V ac: note (3)	NFC 62210	Kg	5,6	5,8	5,6	5,8	5,6	5,8	5,6	5,8	5,6	5,8					
PESO - WEIGHT MF 3 pole - con scheda elettronica - with control card 24V dc: note (2) and 220V-240V ac: note (3)	NFC 62210	Kg	6,6	6,8	6,6	6,8	6,6	6,8	6,6	6,8	6,6	6,8					
PESO - WEIGHT MF 4 pole 24V dc: note (2) and 220V-240V ac: note (3)	NFC 62210	Kg	6,2	6,4	6,2	6,4	6,2	6,4	6,2	6,4	6,2	6,4					
PESO - WEIGHT MF 4 pole - con scheda elettronica - with control card 24V dc: note (2) and 220V-240V ac: note (3)	NFC 62210	Kg	7,2	7,4	7,2	7,4	7,2	7,4	7,2	7,4	7,2	7,4					
PESO - WEIGHT MF 3 pole 24V dc: note (2) and 220V-240V ac: note (3)	DIN 43620	Kg	5,7	5,9	5,7	5,9	5,7	5,9	5,7	5,9	5,7	5,9					
PESO - WEIGHT MF 3 pole - con scheda elettronica - with control card 24V dc: note (2) and 220V-240V ac: note (3)	DIN 43620	Kg	6,7	6,9	6,7	6,9	6,7	6,9	6,7	6,9	6,7	6,9					
PESO - WEIGHT MF 4 pole 24V dc: note (2) and 220V-240V ac: note (3)	DIN 43620	Kg	6,3	6,5	6,3	6,5	6,3	6,5	6,3	6,5	6,3	6,5					
PESO - WEIGHT MF 4 pole - con scheda elettronica - with control card 24V dc: note (2) and 220V-240V ac: note (3)	DIN 43620	Kg	7,3	7,5	7,3	7,5	7,3	7,5	7,3	7,5	7,3	7,5					
PESO - WEIGHT MF 3 pole 24V dc: note (2) and 220V-240V ac: note (3)	BS 88	Kg	5,8	6	5,8	6	5,8	6	5,8	6	5,8	6					
PESO - WEIGHT MF 3 pole - con scheda elettronica - with control card 24V dc: note (2) and 220V-240V ac: note (3)	BS 88	Kg	6,8	7	6,8	7	6,8	7	6,8	7	6,8	7					
PESO - WEIGHT MF 4 pole 24V dc: note (2) and 220V-240V ac: note (3)	BS 88	Kg	6,3	6,4	6,3	6,4	6,3	6,4	6,3	6,4	6,3	6,4					
PESO - WEIGHT MF 4 pole - con scheda elettronica - with control card 24V dc: note (2) and 220V-240V ac: note (3)	BS 88	Kg	7,3	7,4	7,3	7,4	7,3	7,4	7,3	7,4	7,3	7,4					

note (1) a causa delle armoniche e delle tolleranze dei condensatori, i valori nominali devono essere ridotti del 33% - due to harmonics and tolerance of the capacitors, the rated values have been reduced by 33%





fusibili DIN  
DIN fuses

fusibili esclusi  
dalla fornitura  
fuses out of supply

da 220V a 240V corrente alternata  
from 220V to 240V alternating current 50/60 Hz

codici per ordini - ordering codes

IMF \ D	125A NH0	125A NH00	160A NH0	160A NH00	250A NH1-2	400A NH1-2	630A NH3	800A NH4	1000A NH4	1250A NH4
3 pole	EIMF01253010A	EIMF01253020A	EIMF01603010A	EIMF01603020A	EIMF02503030A	EIMF04003040A	EIMF06303050A	EIMF08003080A	EIMF10003080A	EIMF12503080A
4 pole	EIMF01254012A	EIMF01254022A	EIMF01604012A	EIMF01604022A	EIMF02504032A	EIMF04004042A	EIMF06304052A	EIMF08004082A	EIMF10004082A	EIMF12504082A



fusibili BS  
BS fuses

da 220V a 240V corrente alternata  
from 220V to 240V alternating current 50/60 Hz

codici per ordini - ordering codes

IMF \ B	125A A4	160A B1-B2	250A B1-B3	400A B1-B4	630A C1-C2	800A D1	1000A D1	1250A D1
3 pole	EIMF01253110A	EIMF01603130A	EIMF02503140A	EIMF04003150A	EIMF06303170A	EIMF08003190A	EIMF10003190A	EIMF12503190A
4 pole	EIMF01254112A	EIMF01604132A	EIMF02504142A	EIMF04004152A	EIMF06304172A	EIMF08004192A	EIMF10004192A	EIMF12504192A

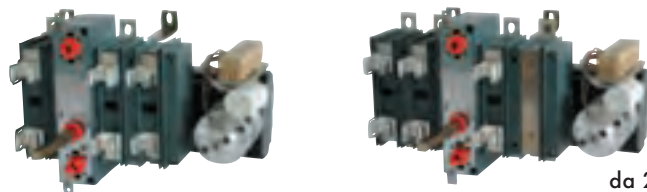

fusibili NFC  
NFC fuses

da 220V a 240V corrente alternata  
from 220V to 240V alternating current 50/60 Hz

codici per ordini  
ordering codes

IMF \ N	125A 22x58
3 pole	EIMF01253070A
4 pole	EIMF01254072A

Per ordinare il 24V a corrente continua sostituire la lettera finale **A** del codice del prodotto (IMF 220V-240V) con la lettera **H**.  
Esempio EIMF01253020**A** diventa EIMF01253020**H**  
To order 24V direct current replace the letter **A** of IMF 220V-240V ordering code with letter **H**. Example: EIMF01253020**A** becomes EIMF01253020**H**

Per altre esecuzioni contattare il nostro ufficio tecnico - Please contact our technical department for other executions

nota: per gli ordini in Italia sostituire con la J la E iniziale nel codice prodotto



fusibili DIN  
DIN fuses

completi di  
scheda elettronica  
di controllo  
complete with  
electronic control  
card

da 220V a 240V corrente alternata  
from 220V to 240V alternating current 50/60 Hz

codici per ordini - ordering codes

IMF \ D/S	125A NH0	125A NH00	160A NH0	160A NH00	250A NH1-2	400A NH1-2	630A NH3	800A NH4	1000A NH4	1250A NH4
3 pole	EIMF01253010S	EIMF01253020S	EIMF01603010S	EIMF01603020S	EIMF02503030S	EIMF04003040S	EIMF06303050S	EIMF08003080S	EIMF10003080S	EIMF12503080S
4 pole	EIMF01254012S	EIMF01254022S	EIMF01604012S	EIMF01604022S	EIMF02504032S	EIMF04004042A	EIMF06304052S	EIMF08004082S	EIMF10004082S	EIMF12504082S

per le tabelle dimensionali e i disegni vedi pag. 30  
see page 30 for dimensional tables and drawings

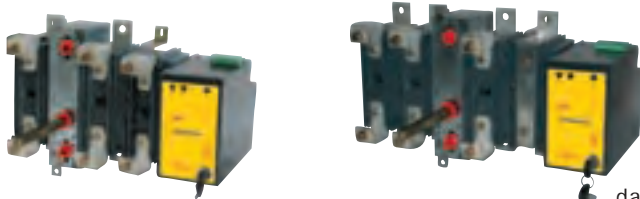

fusibili BS  
BS fuses

codici per ordini - ordering codes

da 220V a 240V corrente alternata  
from 220V to 240V alternating current 50/60 Hz

completi di scheda elettronica di controllo  
complete with electronic control card

IMF <sub>NBS</sub>	125A A4	160A B1-B2	250A B1-B3	400A B1-B4	630A C1-C2	800A D1	1000A D1	1250A D1
3 pole	EIMF01253110S	EIMF01603130S	EIMF02503140S	EIMF04003150S	EIMF06303170S	EIMF08003190S	EIMF10003190S	EIMF12503190S
4 pole	EIMF01254112S	EIMF01604132S	EIMF02504142S	EIMF04004152S	EIMF06304172S	EIMF08004192S	EIMF10004192S	EIMF12504192S



fusibili NFC  
NFC fuses

codici per ordini - ordering codes

IMF <sub>NBS</sub>	125A 22x58
3 pole	EIMF01253070S
4 pole	EIMF01254072S

da 220V a 240V corrente alternata  
from 220V to 240V alternating current 50/60 Hz

completi di scheda elettronica di controllo  
complete with electronic control card

Per ordinare il 24V a corrente continua sostituire la lettera finale **S** del codice del prodotto (IMF 220V-240V) con la lettera **T**.

Esempio EIMF01253020**S** diventa EIMF01253020**T**

To order 24V direct current replace the letter **S** of IMF 220V-240V ordering code with letter **T**. Example: EIMF01253020**S** becomes EIMF01253020**T**

Per altre esecuzioni contattare il nostro ufficio tecnico - Please contact our technical department for other executions

nota: per gli ordini in Italia sostituire con la J la E iniziale nel codice prodotto

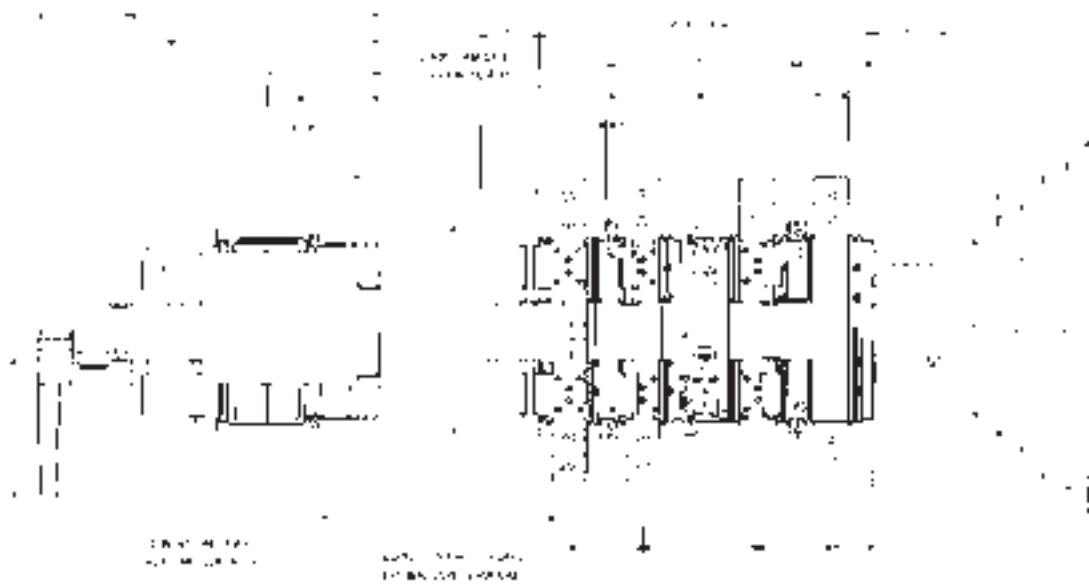

	A	B <sub>1</sub>	B <sub>2</sub>	C	D	D <sub>1</sub>	D <sub>2</sub>	E	F	G	H	I	J	K	L	M	N	O	P	R	S	T	U	V	X	Z	□	∅	Ω
	3-4 pole																												
IMF 125A																													
IMF 160A	230	174	-	154	185	1055	795	1235	44	-	32,5	92	-	125	20	136	51,5	203	71,5	-	123	81	87	-	224	3	10	8,5	70
IMF 200A																													
IMF 250A															25											4			
IMF 315A	307	220	-	190	205	1165	885	150	65	-	39,5	112	330	125	30	177	72	235	96	-	123	85	82	7,8	284	5	12	10,5	83,5
IMF 400A																													
IMF 630A																						85				6			
IMF 800A		292	-	252	253	1515	1015	208	87	-	49	134	445	166	40	221	89	305	112	246	148					8	12	13	89
IMF 1000A	392			252	253	1515	1015	208	87	-	49	134	445	166	40	221	89	305	112	246	148	107	93	68	394	10			
IMF 1250A			352								30																		

# ACCESSORI - ACCESSORIES

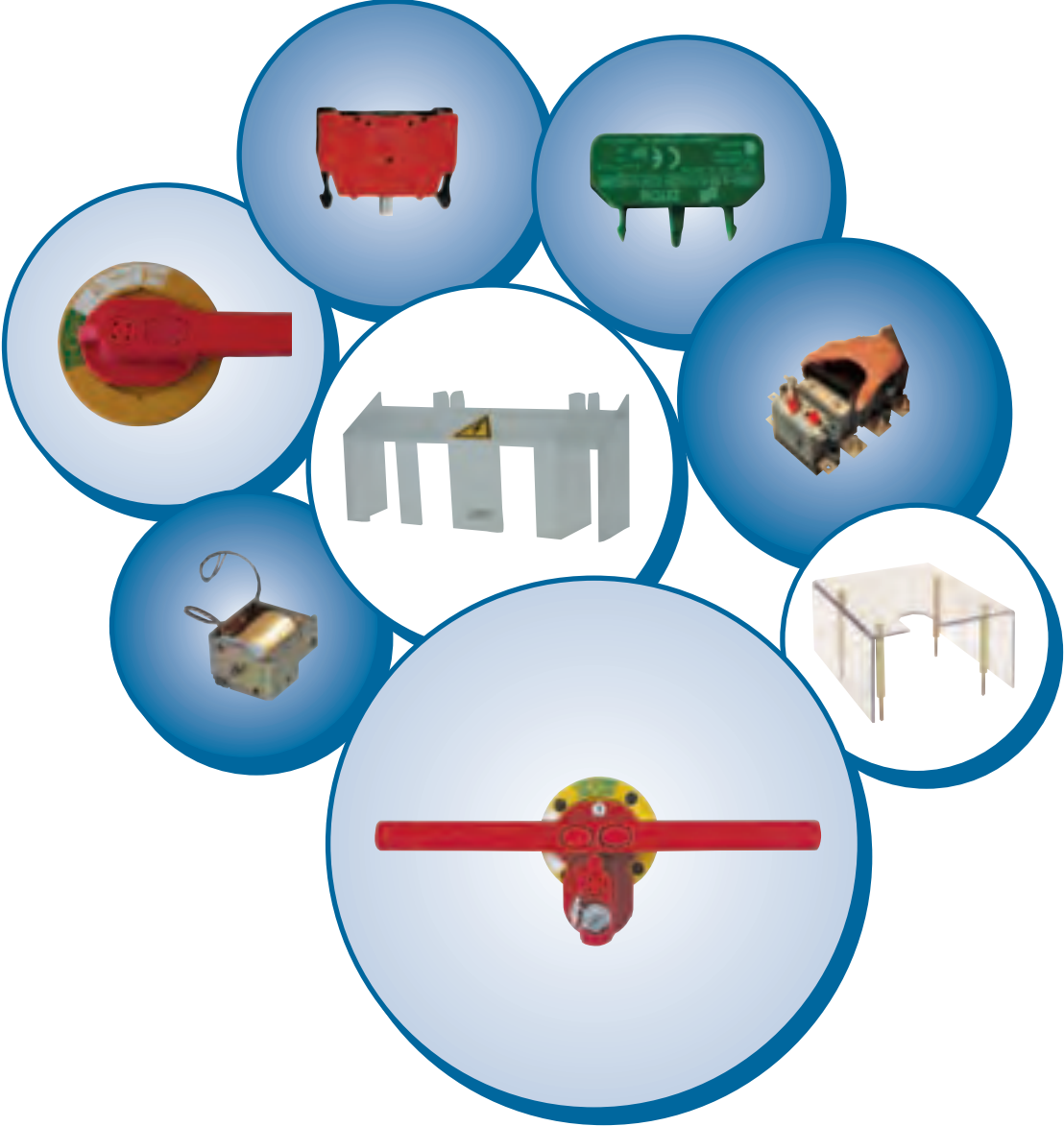

**MANIGLIE -**

per IHS 32A ÷ 200A IHF 32A ÷ 160A

per IHS 32A ÷ 200A IHF 32A ÷ 160A con indicazione di precarica per la bobina di sgancio

**HANDLES -**

for IHS 32A ÷ 200A IHF 32A ÷ 160A

for IHS 32A ÷ 200A IHF 32A ÷ 160A with pre-charge indication for release coil

maniglia piccola rinviata pos. 0-I  
small handle for door pos. 0-I

adatta per - suitable for

IHS 32A÷63A 3-4 pole

IHF 32A÷63A 3-4 pole



Code	con blocco porta (di serie) with door lock (standard)	con blocco a chiave with key lock	con sblocco porta with door interlock override	con blocco a chiave e sblocco porta with key lock and door interlock override
nera - black	EXMN01100001A	EXMN01101001A	EXMN01100101A	EXMN01101101A
rossa - red	EXMN03100001A	EXMN03101001A	EXMN03100101A	EXMN03101101A

maniglia rinviata pos. 0-I  
handle for door pos. 0-I

adatta per - suitable for

IHS 80A÷250A 3-4 pole

IHF 80A÷160A 3-4 pole



Code	con blocco porta (di serie) with door lock (standard)	con blocco a chiave with key lock	con sblocco porta with door interlock override	con blocco a chiave e sblocco porta with key lock and door interlock override
nera - black	EXMN11100001A	EXMN11101001A	EXMN11100101A	EXMN11101101A
rossa - red	EXMN13100001A	EXMN13101001A	EXMN13100101A	EXMN13101101A

maniglia rinviata con precarica pos. 0-P-I  
handle with pre-charge for door pos. 0-P-I

adatta per - suitable for

IHS 80A÷250A 3-4 pole

IHF 80A÷160A 3-4 pole



Code	con blocco porta (di serie) with door lock (standard)	con blocco a chiave with key lock	con sblocco porta with door interlock override	con blocco a chiave e sblocco porta with key lock and door interlock override
nera - black	EXMN11100007A	EXMN11101007A	EXMN11100107A	EXMN11101107A
rossa - red	EXMN13100007A	EXMN13101007A	EXMN13100107A	EXMN13101107A

maniglia piccola diretta  
small direct short handle

adatta per - suitable for

IHS 32A÷63A 3-4 pole

IHF 32A÷63A 3-4 pole

maniglia diretta  
direct handle

adatta per - suitable for

IHS 80A÷250A 3-4 pole

IHF 80A÷160A 3-4 pole



Code	(per albero $\varnothing$ 106) (for shaft $\varnothing$ 106)
nera - black	EXMN01160000A
rossa - red	EXMN03160000A

Code	(per albero $\varnothing$ 108) (for shaft $\varnothing$ 108)
nera - black	EXMN01180000A
rossa - red	EXMN03180000A

blocco a chiave  
key lock

il blocco delle maniglie può essere tenuto in posizione di 0 - OFF e I - ON o in entrambe le posizioni

the lock of the handles can be locked in either O - OFF or I - ON position or in both positions



EXHBC

Code

guarnizione in gomma  
handle sealing

per maniglie IP 55  
for IP 55 handles

EXG08

Code



dispositivo di sblocco porta  
door interlock override

Applicabile a tutte le maniglie rinviate, si attiva dall'esterno del pannello. Permette l'apertura del portello in posizione di I-ON.

Applicable to all the handles for door. It must be activated from outside the panel. It allows the opening of the door in the I-ON position.



Dime di foratura serie "H"  
Drilling template H series

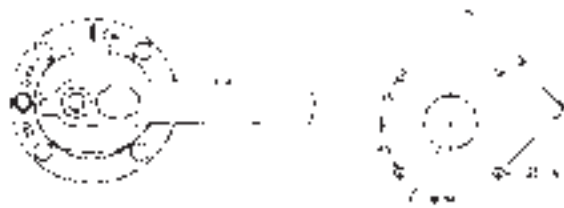

prolunga d'albero con giunzione  
shaft extension with junction

adatta per  
suitable for

IHS 32A÷63A 3-4 pole  
IHF 32A÷63A 3-4 pole



Lunghezza Length 180 mm	Lunghezza Length 240 mm	Lunghezza Length 280 mm
EXT060180	EXT060240	EXT060280

Code

giunzione per prolunga  
junction for shaft extension

Code

EXM06



prolunga d'albero con giunzione  
shaft extension with junction

adatta per  
suitable for

IHS 80A÷250A 3-4 pole  
IHF 80A÷160A 3-4 pole



Lunghezza Length 180 mm	Lunghezza Length 240 mm	Lunghezza Length 280 mm
EXT080180	EXT080240	EXT080280

Code

giunzione per prolunga  
junction for shaft extension

Code

EXM08



schermo di protezione fusibili  
fuse protection shield

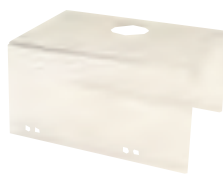

Code

3 poli - 3 pole	EXHCF13	EXHCF13B	EXHCF23	EXHCF33
4 poli - 4 pole	EXHCF14	EXHCF14B	EXHCF24	EXHCF34
IHF	32A÷63A DIN	32A÷63A NFC • BS	80A÷100A	125A÷160A

adatto per  
suitable for

Per fissare i coprifusibili è necessario acquistare i coprimorsetti superiore inferiore.  
To fit the fuse protection shield it's necessari to purchase the top and bottom terminal covers

copribarrette per contatti principali per IHS  
link bar covers for main contacts for IHS

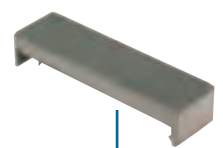

Code

	EXHCB1	EXHCB2	EXHCB3
IHS	32A÷63A	80A÷125A	160A÷250A

adatto per  
suitable for



coprimorsetti  
terminal covers

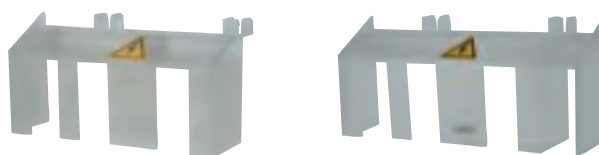

Code

3 poli superiore - 3 pole top	EXHCS13	EXHCI13	EXHCS23	EXHCI23	EXHCS33	EXHCI33
4 poli inferiore - 4 pole bottom	EXHCS14	EXHCI14	EXHCS24	EXHCI24	EXHCS34	EXHCI34
	IHF	32A÷63A	80A÷100A	125A÷160A		
	IHS	32A÷63A	80A÷125A	160A÷250A		

adatto per  
suitable for



Bobina di sgancio - Release coil

adatta per - suitable for

- IHS 80A÷200A 3-4 pole
- IHF 80A÷160A 3-4 pole



Microswitch

Contatto di risparmio di intervento della bobina di apertura dell'interruttore

Microswitch

Protection contact for release coil.



Code	48V 50Hz	110V 50Hz	220V 50Hz	24V d.c.	48V d.c.	60V d.c.	100V d.c.
EXHBA.....	AC048	AC110	AC220	DC024	DC048	DC060	DC100

Code	EXHSW
------	-------

contatti ausiliari

a richiesta, tutti gli interruttori possono essere equipaggiati con contatti ausiliari che potranno essere anticipati o ritardati rispetto al contatto principale (come diagramma sottoriportato \*). I contatti ausiliari possono essere protetti da una apposita calotta contro i contatti accidentali.

auxiliary contacts

on request, all switches can be equipped with auxiliary contacts, that can be leading or lagging as regard the main contacts (see the diagram below \*). The auxiliary contacts can be protected with a cover against accidental touches.

potere di interruzione	AC11	V	24	110	220	380	600
		A	10	6,5	4,5	2,6	1,6
breaking capacity	DC11	V	24	110	220	380	600
		A	5	1,1	0,6	0,3	0,15

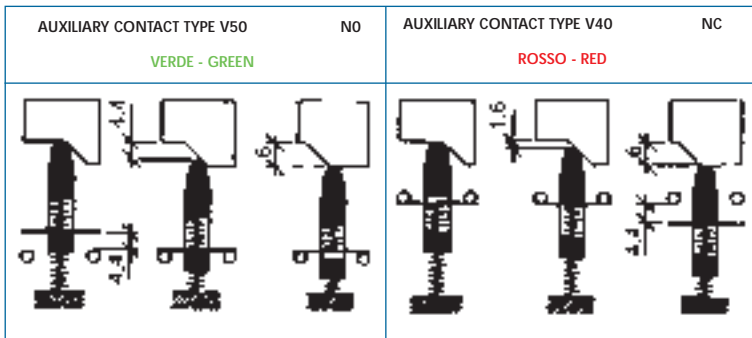
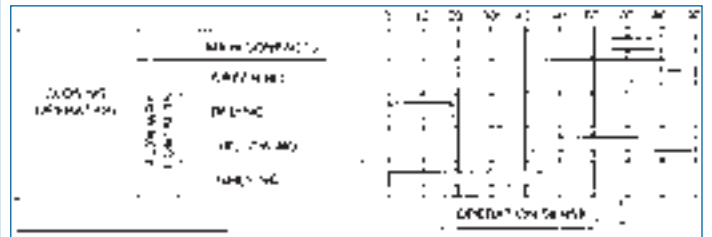
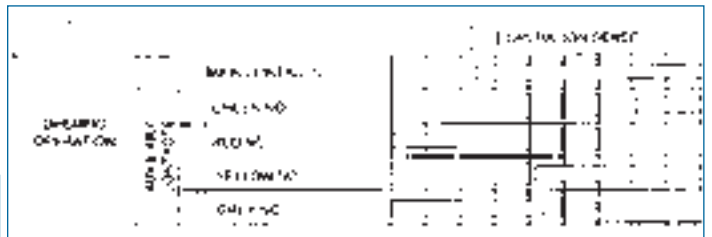

1NO	1NC	1NO+1NC	1NO+1NO	1NC+1NC	2NO+2NC	2NO+2NO	2NC+2NC
EXHCAU11V	EXHCAU12	EXHCAU13V	EXHCAU14V	EXHCAU15	EXHCAU16V	EXHCAU17V	EXHCAU18



Legenda - Legend  
■ Aperto - Open  
■ Chiuso - Closed

1NO	1NC	1NO+1NC	1NO+1NO	1NC+1NC	2NO+2NC	2NO+2NO	2NC+2NC
EXHCAU1V	EXHCAU2	EXHCAU3V	EXHCAU4V	EXHCAU5	EXHCAU6V	EXHCAU7V	EXHCAU8



i contatti ausiliari sono forniti completi di:  
 the auxiliary contacts are supplied complete with:



Code

	EXHCMAU1	EXHCMAU2	EXHCMAU3
adatto per / suitable for	IHF	80A÷100A	125A÷160A
	IHS	80A÷125A	160A÷250A

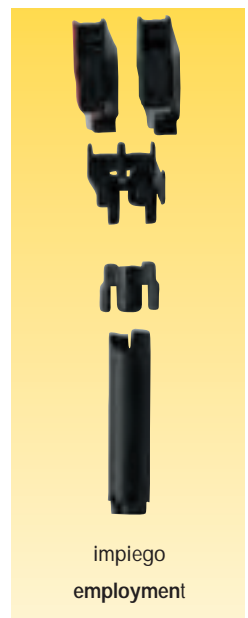

impiego  
 employment

**MANIGLIE RINVIATE** - (di serie) per interruttori di manovra sezionatori INS, INP e interruttori di manovra sezionatori con fusibili INF e IHF 800A ÷ 1250A  
 (nota bene: chiedere all'ufficio tecnico) per interruttori di manovra sezionatori motorizzati IMV e interruttori di manovra sezionatori motorizzati con fusibili IMF  
**HANDLES FOR DOOR** - (standard) for switch-disconnectors INS, INP and switch-disconnector-fuses INF and IHF 800A÷1250A  
 (contact our technical department) for motor-driven switch-disconnectors IMV and motor-driven switch-disconnector-fuses IMF

maniglia corta rinvia pos. 0-I  
 short handle for door pos. 0-I



adatta per - suitable for

INS	63A÷400A	3-4 pole
INS	63A÷400A	6-8 pole
INS	630A medium	3-4 pole
INS	630A medium	6-8 pole
INF	63A 160A	3-4 pole
INF	200A short	3-4 pole
INF	200A medium	3-4 pole
INF	250A÷400A	3-4 pole
INP	250A÷1000A	3-4 pole

Code	con blocco porta (di serie) with door lock (standard)	con blocco a chiave with key lock	con sblocco porta with door interlock override	con blocco a chiave e sblocco porta with key lock and door interlock override
nera - black	EXMN11200001A	EXMN11201001A	EXMN11200101A	EXMN11201101A
rossa - red	EXMN13200001A	EXMN13201001A	EXMN13200101A	EXMN13201101A

maniglia lunga rinvia pos. 0-I  
 long handle for door pos. 0-I

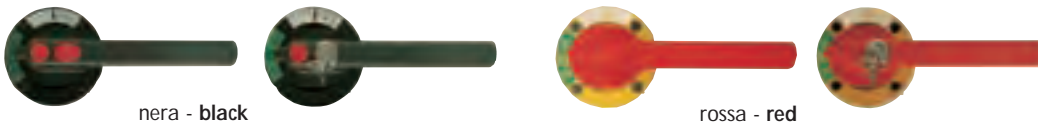

adatta per - suitable for

INS	630A big	3-4 pole
INS	630A big	6-8 pole
INS	800A÷1000A	3-4 pole
INS	800A÷1000A	6-8 pole
INF	630A÷800A	3-4 pole
IHF	800A÷1250A	3-4 pole
INP	1250A÷2000A	3-4 pole

Code	con blocco porta (di serie) with door lock (standard)	con blocco a chiave with key lock	con sblocco porta with door interlock override	con blocco a chiave e sblocco porta with key lock and door interlock override
nera - black	EXMN21200001A	EXMN21201001A	EXMN21200101A	EXMN21201101A
rossa - red	EXMN23200001A	EXMN23201001A	EXMN23200101A	EXMN23201101A

maniglia doppia rinvia pos. 0-I  
 double handle for door pos. 0-I

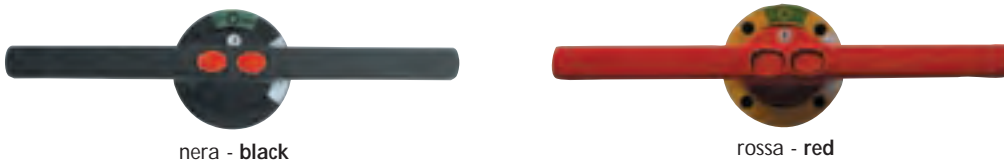

adatta per - suitable for

INP	2500A÷7000A	3-4 pole
-----	-------------	----------

Code	senza blocco lucchetto (di serie) without padlock facility (standard)	con blocco lucchetto with padlock facility	con sblocco porta with door interlock override
nera - black	EXMN41200001A	EXMN31200001A	EXMN31200101A
rossa - red	EXMN43200001A	EXMN33200001A	EXMN33200101A



Code	con blocco a chiave with key lock	con blocco a chiave e sblocco porta with key lock and door interlock override
nera - black	EXMN31201001A	EXMN31201101A
rossa - red	EXMN33201001A	EXMN33201101A

maniglia corta rinvia pos. I-O (manovra antioraria)  
short handle for door pos. I-O (anticlockwise operation)



nera - black

rossa - red

adatta per - suitable for

INS	63A÷400A	3-4 pole
INS	63A÷400A	6-8 pole
INS	630A medium	3-4 pole
INS	630A medium	6-8 pole
INF	63A ÷160A	3-4 pole
INF	200A short	3-4 pole
INF	200A medium	3-4 pole
INF	250A÷400A	3-4 pole
INP	250A÷1000A	3-4 pole

Code	con blocco porta (di serie)	con blocco a chiave	con sblocco porta	con blocco a chiave e sblocco porta
	with door lock (standard)	with key lock	with door interlock override	with key lock and door interlock override
nera - black	EXMN11200002A	EXMN11201002A	EXMN11200102A	EXMN11201102A
rossa - red	EXMN13200002A	EXMN13201002A	EXMN13200102A	EXMN13201102A

maniglia lunga rinvia pos. I-O (manovra antioraria)  
long handle for door pos. I-O (anticlockwise operation)

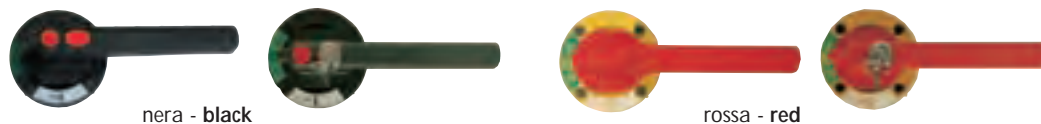

nera - black

rossa - red

adatta per - suitable for

INS	630A big	3-4 pole
INS	630A big	6-8 pole
INS	800A÷1000A	3-4 pole
INS	800A÷1000A	6-8 pole
INF	630A÷ 800A	3-4 pole
IHF	800A÷1250A	3-4 pole
INP	1250A÷2000A	3-4 pole

Code	con blocco porta (di serie)	con blocco a chiave	con sblocco porta	con blocco a chiave e sblocco porta
	with door lock (standard)	with key lock	with door interlock override	with key lock and door interlock override
nera - black	EXMN21200002A	EXMN21201002A	EXMN21200102A	EXMN21201102A
rossa - red	EXMN23200002A	EXMN23201002A	EXMN23200102A	EXMN23201102A

maniglia doppia rinvia pos. I-O (manovra antioraria)  
double handle for door pos. I-O (anticlockwise operation)



nera - black

rossa - red

adatta per - suitable for

INP	2500A÷7000A	3-4 pole
-----	-------------	----------

Code	senza blocco lucchetto (di serie)	con blocco lucchetto	con sblocco porta
	without padlock facility (standard)	with padlock facility	with door interlock override
nera - black	EXMN41200002A	EXMN31200002A	EXMN31200102A
rossa - red	EXMN43200002A	EXMN33200002A	EXMN33200102A

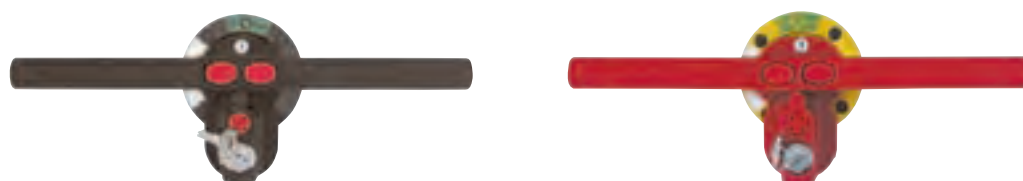

nera - black

rossa - red

Code	con blocco a chiave	con blocco a chiave e sblocco porta
	with key lock	with key lock and door interlock override
nera - black	EXMN31201002A	EXMN31201102A
rossa - red	EXMN33201002A	EXMN33201102A

**MANIGLIE DIRETTE - (di serie) per interruttori di manovra sezionatori motorizzati IMV e interruttori di manovra sezionatori motorizzati con fusibili IMF**  
**DIRECT HANDLES - (standard) for motor-driven switch-disconnectors IMV and motor-driven switch-disconnector-fuses IMF**

maniglia corta diretta  
direct short handle



nera - black



rossa - red



Code (per albero  $\varnothing 10$ )  
(for shaft  $\varnothing 10$ )

nera - black	EXMN11240000A
rossa - red	EXMN13240000A

adatta per - suitable for

IMV	125A÷200A	3-4 pole
IMV	250A short	3-4 pole
IMV	125A÷200A	6-8 pole
IMV	250A short	6-8 pole

Code (per albero  $\varnothing 12$ )  
(for shaft  $\varnothing 12$ )

nera - black	EXMN11220000A
rossa - red	EXMN13220000A

adatta per - suitable for

IMV	250A medium	3-4 pole
IMV	315A÷630A	3-4 pole
IMV	250A medium	6-8 pole
IMV	315A÷630A	6-8 pole
IMV	800A÷1000A	3-4 pole

maniglia lunga diretta  
direct long handle



nera - black



rossa - red



Code (per albero  $\varnothing 12$ )  
(for shaft  $\varnothing 12$ )

nera - black	EXMN21220000A
rossa - red	EXMN23220000A

adatta per - suitable for

IMV	800A÷1000A	6-8 pole
IMV	1250A÷2000A	3-4 pole

maniglia doppia diretta  
direct double handle



nera - black



rossa - red

Code (per albero  $\varnothing 12$ )  
(for shaft  $\varnothing 12$ )

nera - black	EXMN31220000A
rossa - red	EXMN33220000A

adatta per - suitable for

IMV	2500A÷7000A	3-4 pole
-----	-------------	----------

blocco posizione maniglia a porta aperta  
position handle block with open door



impedisce il cambio di posizione della maniglia a porta aperta.  
prevents to move the handle when the door is open

Code EXNDS2

dispositivo di sblocco porta  
door interlock override

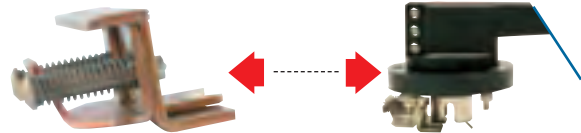

Code EXNDS

Applicabile a tutte le maniglie rinviate, si attiva dall'esterno del pannello. Permette l'apertura del portello in posizione di I-ON.

Applicable to all the handles for door. It must be activated from outside the panel. It allows the opening of the door in the I-ON position.

prolunga d'albero con giunzione  
shaft extension with junction



Lunghezza Length 180 mm	Lunghezza Length 240 mm	Lunghezza Length 280 mm
EXT100180	EXT100240	EXT100280

adatta per suitable for

INF	63A÷160A
INF	200A short
INS	63A÷200A
INP	250A÷400A
IMV	125A÷200A
IMV	250A short
IMF	125A÷200A

prolunga d'albero con giunzione  
shaft extension with junction



Lunghezza Length 180 mm	Lunghezza Length 240 mm	Lunghezza Length 280 mm
EXT120180	EXT120240	EXT120280

adatta per suitable for

INF	200A medium
INF	250A÷800A
IHF	800A÷1250A
INS	250A÷1000A
INP	630A÷6300A
IMV	250A medium
IMV	315A÷7000A
IMF	250A÷1250A

giunzione per prolunga  
junction for shaft extension



Code EXM10

giunzione per prolunga  
junction for shaft extension



Code EXM12

blocco a chiave  
key lock



il blocco delle maniglie può essere tenuto in posizione di O - OFF e I - ON o in entrambe le posizioni  
the lock of the handles can be locked in either O - OFF or I - ON position or in both positions

Code per maniglia singola for single handle  
EXNBC

note: per l'uso con maniglia doppia chiedere all'ufficio tecnico  
note: for double handle contact our technical department  
vedi maniglie codici pag 35-36 - see handle codes pag 35-36

EXMN31201001A	EXMN31201101A	EXMN33201001A	EXMN33201101A
EXMN31201002A	EXMN31201102A	EXMN33201002A	EXMN33201102A

guarnizione in gomma  
handle sealing



Code per maniglie IP 55 for IP 55 handles  
EXG12

anello per ribassare le maniglie rinviate  
ring to lower handles for door



anello - ring

Code EXNDMB



- a Impugnatura
- b Anello
- c Mostrina con impugnatura e anello

maniglia con anello  
handle with ring

anello per abbassare le maniglie rinviate  
ring to lower handles for door

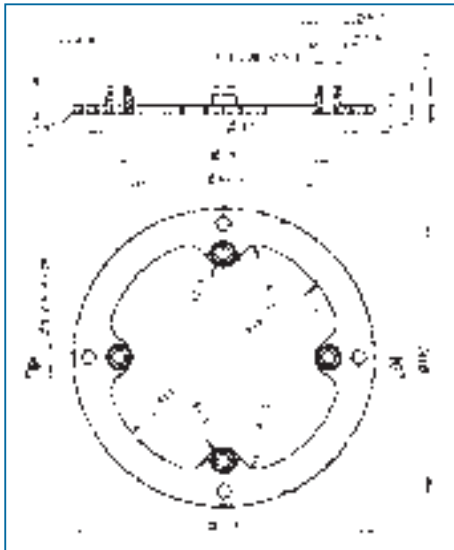

dima di foratura per maniglia bassa  
drilling template for low handle

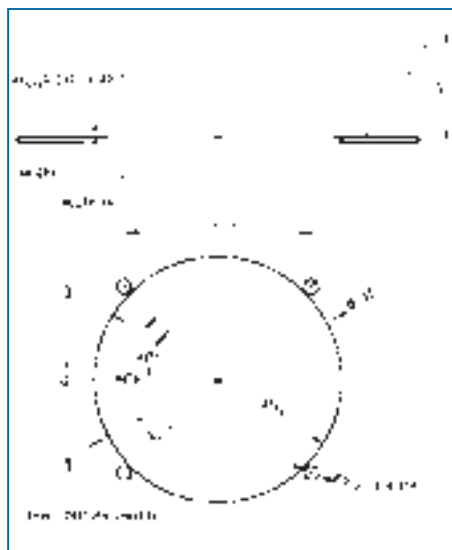

per ordinare la maniglia già completa di anello utilizzare il codice della maniglia rinviate (vedi pagine 41-42) sostituendo la lettera finale **A** del codice con la lettera **R**  
Esempio: EXMN11200001**A** diventa EXMN11200001**R**.

to order handle complete with ring replace the letter **A** of handle for door ordering code (pages 41-42) with the letter **R**  
Esempio: EXMN11200001**A** becomes EXMN11200001**R**

dime di foratura per maniglia rinviate  
drilling template for handles for door

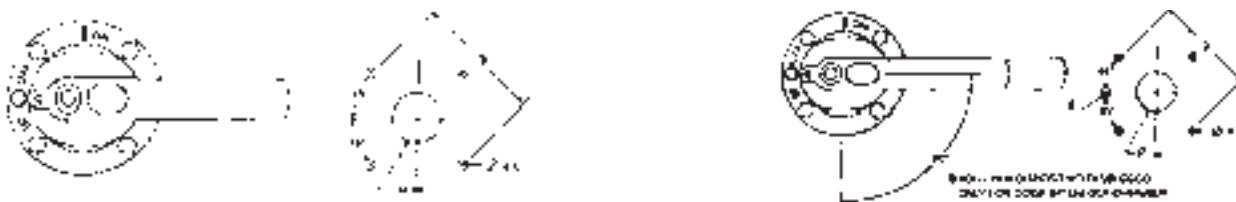



schermi di protezione contatti principali  
protection shield for main contacts



da utilizzare in alternativa ai copribarrette oppure con il sezionamento visibile  
to be used instead of link bar covers or with the visible isolation

3 - 4° polo addossato - 3 and 4th leaning pole		EXNC33S		EXNC43S		EXNC53S	
4 poli (polo laterale) - 4 pole (side pole)			EXCN34S		EXCN44S		EXNC54S
Code	adatto per suitable for	INS	125A÷200A	250A÷400A	630A÷1000A		

schermi di protezione fusibili per serie INF  
fuse protection shield for INF series

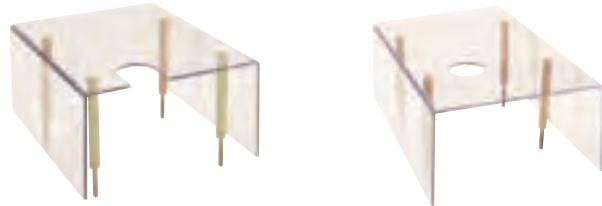

3 - 4° polo addossato - 3 and 4th leaning pole		EXNCF33		EXNCF43		EXNCF53	
4 poli (polo laterale) - 4 pole (side pole)			EXCNF34		EXCNF44		EXNCF54
Code	adatto per suitable for	INF	125A÷200A	250A÷400A	630A÷1000A		

schermi di protezione fusibili per IHF 800A ÷ 1250A e IMF 125A ÷ 1250A  
fuse protection shield for IHF 800A ÷ 1250A e IMF 125A ÷ 1250A

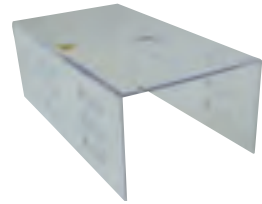

3 poli - 3 pole		EXKCF33		EXKCF43		EXKCF53		EXKCF6
4 poli - 4 pole			EXCKF34		EXCKF44		EXKCF54	
Code	adatto per suitable for	IHF - IMF	125A÷200A (IMF)	250A÷400A (IMF)	630A (IMF)	800A÷1250A (IHF -IMF)		

schermi di protezione contatti principali con copriterminali inglobati per INP 3-4 poli  
protection shield for main contacts and terminal covers for INP 3-4 pole

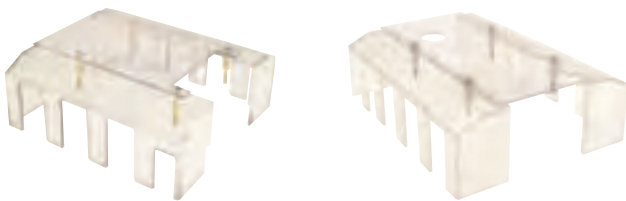

3 - 4° polo addossato - 3 and 4th leaning pole		EXNC33P		EXNC43P		EXNCP53P	
4 poli (polo laterale) - 4 pole (side pole)			EXNC34P		EXNC44P		EXNC54P
Code	adatto per suitable for	INP	250A÷400A	630A÷1000A	1250A÷2000A		

schermi di protezione contatti principali con copriterminali inglobati per INS 6-8 poli  
protection shield for main contacts and terminal covers for INS 6-8 pole

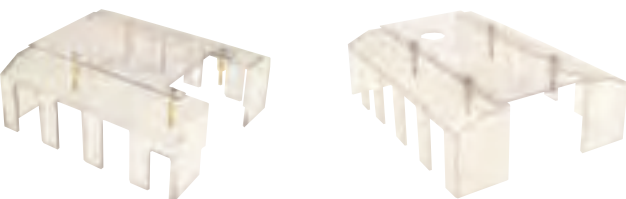

Per fissare i coprifusibili è necessario acquistare i copriterminali superiore inferiore.  
To fit the fuse protection shield it's necessary to purchase the top and bottom terminal covers

6 poli - 6 pole		EXNC36S		EXNC46S		EXNC56S	
8 poli - 8 pole			EXNC38S		EXNC48S		EXNC58S
Code	adatto per suitable for	INS	63A÷200A	250A÷630A	630A÷1000A		

coprimerminali per 3 poli e 4° polo addossato per serie N (INF - INP - INS)  
terminal cover for 3 pole and 4th leaning pole for N series (INF - INP - INS)

coprimerminali per 4° polo laterale per serie N (INF - INP - INS)  
terminal cover for 4th side pole for N series (INF - INP - INS)



Code

superiore - top	EXNCS33	EXNCS43	EXNCS53
inferiore - bottom	EXNCI33	EXNCI43	EXNCI53

adatto per suitable for	INF	63A÷200A	250A÷ 400A	630A÷ 800A
	INS	63A÷200A	250A÷ 630A	630A÷1000A
	INP	250A÷400A	630A÷1000A	1250A÷2000A

Code

superiore - top	EXNCS34	EXNCS44	EXNCS54
inferiore - bottom	EXNCI34	EXNCI44	EXNCI54

adatto per suitable for	INF	63A÷200A	250A÷ 400A	630A÷ 800A
	INS	63A÷200A	250A÷ 630A	630A÷1000A
	INP	250A÷400A	630A÷1000A	1250A÷2000A

coprimerminali per 3 poli per IHF 800A ÷ 1250A e IMF 125A ÷ 1250A  
terminal cover for 3 pole for IHF 800A ÷ 1250A and IMF 125A ÷ 1250A

coprimerminali per 4 poli per IHF 800A ÷ 1250A e IMF 125A ÷ 1250A  
terminal cover for 4 pole for IHF 800A ÷ 1250A and IMF 125A ÷ 1250A



Code

superiore - top	EXKCS33	EXKCS43	EXKCS53
inferiore - bottom	EXKCI33	EXKCI43	EXKCI53

adatto per suitable for	IHF	-	-	800A÷1250A
	IMF	125A÷200A	250A÷630A	800A÷1250A

Code

superiore - top	EXKCS34	EXKCS44	EXKCS54
inferiore - bottom	EXKCI34	EXKCI44	EXKCI54

adatto per suitable for	IHF	-	-	800A÷1250A
	IMF	125A÷200A	250A÷630A	800A÷1250A

dispositivo di segnalazione scattato fusibile  
fuse blows-up signalling device

Code

EXNDSFC	EXNDSFA
CC - DC	CA - AC

Schema di collegamento del  
dispositivo di segnalazione  
intervento fusibile  
Fuse blows-up signalling  
device wiring scheme

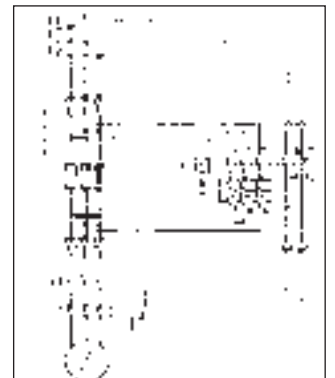

dispositivo di comando di due interruttori in tandem  
tandem coupling switches operating mechanism



Code

	EXNDCI3	EXNDCI4	EXNDCI5	EXNDCI6
INP	250A÷400A	630A÷800A	800A÷1000A	1250A÷2000A
INF	63A÷200A	250A÷400A	630A÷ 800A	-
INS	63A÷200A	250A÷630A	800A÷1000A	-
A	220	288	336	384

copribarrette per contatti principali per INS  
link bar covers for main contacts for INS



adatto per  
suitable for

Code	EXNCB3	EXNCB4	EXNCB5
INS	125A÷200A	250A÷630A	630A÷1000A

coprimermorsetti per cavo  
terminals cover for cable



utilizzo con coprimorsetti  
fitted on terminal cover



adatto per  
suitable for

Code	EXKCP4	EXKCP5
INF	250A÷ 400A	630A÷ 800A
INS	250A÷ 630A	630A÷1000A
INP	630A÷1000A	1250A÷2000A
IHF	-	800A÷1250A
IMF	250A÷630A	800A÷1250A

contatti ausiliari

a richiesta, tutti gli interruttori possono essere equipaggiati con contatti ausiliari che potranno essere anticipati o ritardati rispetto al contatto principale (come diagramma sottoriportato \*). I contatti ausiliari possono essere protetti da una apposita calotta contro i contatti accidentali.

auxiliary contacts

on request, all switches can be equipped with auxiliary contacts, that can be leading or lagging as regard the main contacts (see the diagram below \*). The auxiliary contacts can be protected with a cover against accidental touches.

(\*)

potere di interruzione	AC11	V	24	110	220	380	600
		A	10	6,5	4,5	2,6	1,6
breaking capacity	DC11	V	24	110	220	380	600
		A	5	1,1	0,6	0,3	0,15

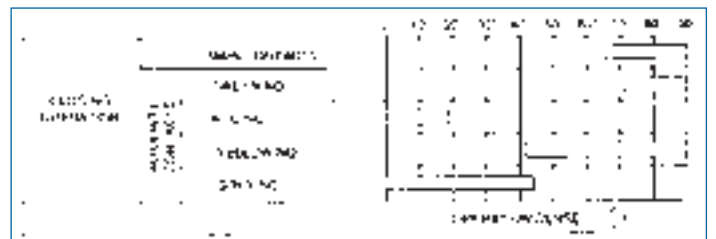
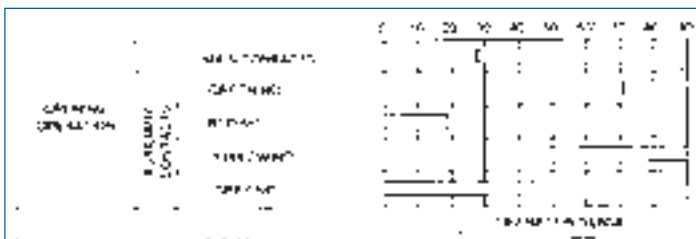
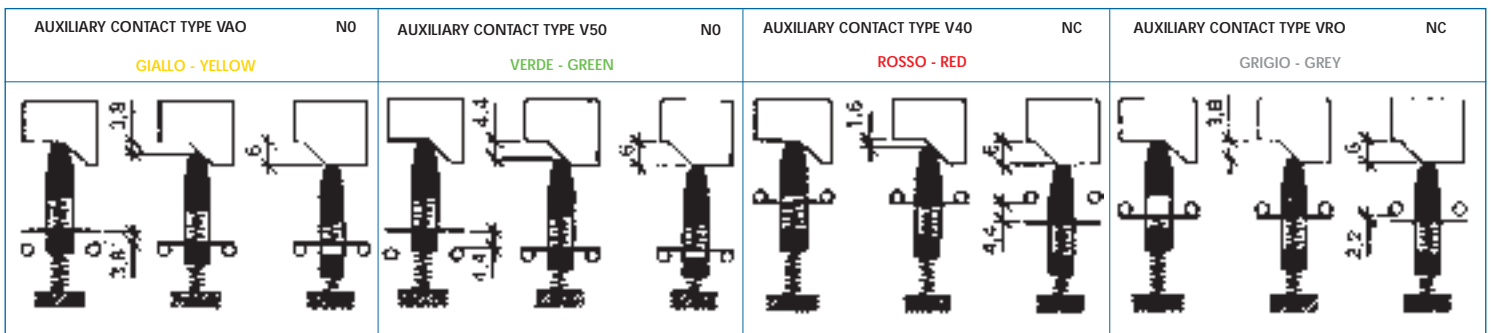

Legenda - Legend

- Aperto - Open
- Aperto - Open
- Chiuso - Closed



i contatti ausiliari sono forniti completi di:  
the auxiliary contacts are supplied complete with:



Code	EXNCAU1	EXNCAU1V	EXNCAU2	EXNCAU3	EXNCAU3V	EXNCAU4	EXNCAU4V	EXNCAU5	EXNCAU6	EXNCAU6V	EXNCAU7	EXNCAU7V	EXNCAU8
	1 NO	1 NO	1 NC	1 NO+1 NC	1 NO+1 NC	1 NO+1 NO	1 NO+1 NO	1 NC+1 NC	2 NO+2 NC	2 NO+2 NC	2 NO+2 NO	2 NO+2 NO	2 NC+2 NC





**Nota A - Note A**

contatti in serie 4 interruzioni per fase  
contacts in series 4 breaking for phase



**Nota B - Note B**

contatti in parallelo doppia interruzione (in serie)  
contacts in parallel double breaking for phase (in series)



**Nota C - Note C**

contatti in serie con fusibili 4 interruzioni per fase  
contacts in series with fuses 4 breaking for phase



**Nota D - Note D**

Per ordinare i sezionatori con manovra inversa (I-O) sostituire la prima lettera del codice con la lettera X.  
Esempio: JHF003230C5A diventa XJHF003230C5A (I-O manovra antioraria).  
To order anticlockwise operation (I-O) switches replace the first letter of code with the letter X.  
Example: EHF0803080A becomes XJHF0803080A

Schema Elettrico di contatti in parallelo  
Parallel contacts electrical scheme



**Nota F - Note F**

vedi tab. pag. 2 e 21 - see tables pages 2 and 21

**Nota G - Note G**

vedi tab. pag. 10 - see table page 10

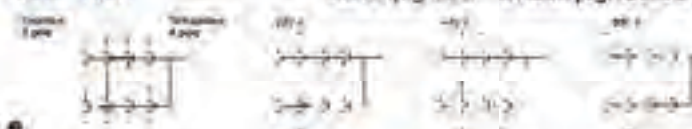

**Nota 1 - Note 1**  
4.to polo laterale sezionato  
4th side switched pole

serie N e H  
N e H series

**Nota 2 - Note 2**

4.to polo laterale passante non sezionabile  
4th side unswitched pole



serie H - H  
series



serie H - H  
series



**Nota 3 - Note 3**  
4.to polo laterale passante sezionabile  
4th side switchable pole

**Nota 4 - Note 4**

4.to polo laterale sezionato con fusibile  
4th side switched pole with fuse



serie N e H  
N e H series



**Nota 5 - Note 5**  
4.to polo addossato sezionato  
4th leaning switched pole

serie N  
N series

**Nota 6 - Note 6**

4.to polo addossato passante non sezionabile  
4th leaning unswitched pole



serie N  
N series



**Nota 7 - Note 7**  
4.to polo laterale sezionato, che porta con continuità una corrente doppia della nominale  
4th side switched pole, can carry the double of the rated current

serie N  
N series

Esempi di polo addossato  
Leaning pole examples



vista polo addossato  
leaning pole view

SEQUENZA APERTURA  
OPENING SEQUENCE



SEQUENZA CHIUSURA  
CLOSING SEQUENCE

La figura rappresenta le posizioni dell'indicatore rispetto alla reale posizione dell'equipaggio mobile. Durante la manovra di apertura la molla raggiunge il punto morto dopo 45° di rotazione, mentre nella manovra di chiusura il punto morto viene raggiunto dopo 70°. L'attuatore rispetta sempre la reale posizione dei contatti. Questo tipo di comando viene chiamato "positivo".

Drawing represents the positions of the indicator respect to the true position of the moving element. During the opening, the spring reaches dead point after a rotation of 45°, while during the closing dead point is reached after 70°. The actuator always respect the real position of the contacts. This type of control is called "positive".

**CONTACTPLASMA - la qualità certificata**

La certificazione del Sistema di Qualità attesta la conformità del processo qualitativo attuato nell'Azienda alle Norme armonizzate europee UNI EN ISO 9001:2000, le quali definiscono i requisiti indispensabili che tali Sistemi devono possedere. Si fa quindi riferimento all'affidabilità dei prodotti, dei servizi industriali ed alla loro rispondenza e garanzia di uniformità nel tempo. La CONTACTPLASMA srl, il 10 Giugno 1997, ha ottenuto da parte CISQRINA tale certificazione, per i processi di produzione sulla totalità dei suoi prodotti.



BUREAU VERITAS Certification  
No. IT260325

**CONTACTPLASMA - Certified quality**

The certification of CONTACTPLASMA quality system proves the conformity of the quality system carried out in the factory with the European standard ISO 9001:2000, in which the essential requirements of such system are established. Therefore reference is made to the reliability of both products and industrial services and their conformance and uniformity guarantee in the long run. On 10 June 1997 CONTACTPLASMA srl has obtained such certification from CISQRINA for the manufacturing processes of its complete range of products.



BUREAU VERITAS Certification  
No. IT260325







**Contact Plasma**

RICERCA TECNOLOGICA ELETTRONICOMECANICA E ELETTRONICA BT/MT  
RESEARCH FOR ELECTRONIC MECHANICAL AND ELECTRONIC BT/MT TECHNOLOGICAL SERVICES

**STABILIMENTO/FABRIK**

Via A. Gramsci, 2 - 26827 Terranova dei Passerini -LO- Italia

Telefono +39 0377 833696 - 832120 fax +39 0377 830442

[www.contactplasma.it](http://www.contactplasma.it)

[www.contactplasma.com](http://www.contactplasma.com)

e-mail [management@contactplasma.it](mailto:management@contactplasma.it)