



Motor protection circuit breakers

Motor protection circuit breakers are used for start-up and protection of electric motors (industry, small machines, external use, agricultural machines, compressors, repair shops, etc.).



Motor protection circuit breakers are a special type of circuit breakers designed for protection of wide range of single-phase and three-phase AC motors against overload and short circuit.

For motor protection:

- All kind of AC induction motors
- For three-phase motors up to 22 kW

Protection of other loads:

- Various low-inductive loads
- Version for single-phase consumers
- Version for transformer protection
- Version for short-circuit protection

Other benefits:

- Wide range accessories
- Mounting on 35 mm rail
- Horizontal or vertical operating position

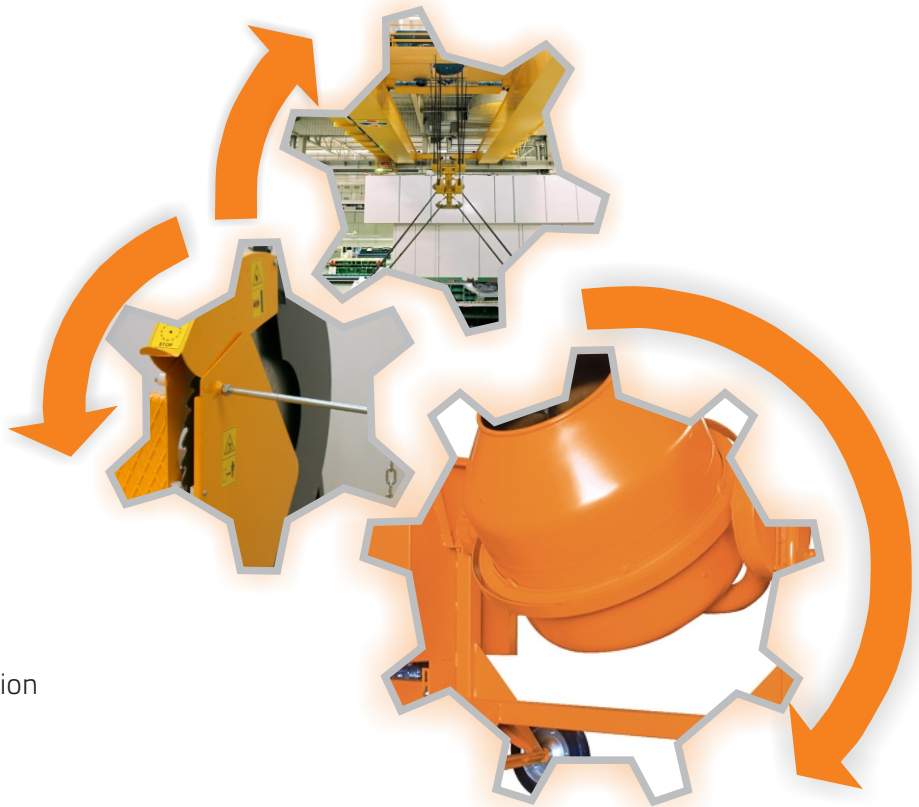

Motor protection circuit breakers MS32 up to 32 A page 2
 Motor protection circuit-breakers MS18 up to 18 A page 3
 Accessories for MS32, MS18 page 4
 Motor protection circuit breakers MS25 up to 25 A page 7
 Accessories for MS25 page 9
 Accessories - general..... page 12

Ordering data page 3, 8
 Technical characteristics page 13
 Dimensions page 24

Motor Protection Circuit Breakers

MS32, MS18



Motor protection circuit-breakers areas of use

Type	Motor protection	Overload protection	Short-circuit protection	Single-phase consumers	Transformer protection
MS18	■	■	■	■	
MS32	■	■	■	■	
MS32-TR		■	■		■

Motor protection circuit breakers MS32

with overload and short-circuit release

AC-3 acc. to IEC/EN 60947-4-1

Type	Setting range (A)	Motor power (3-phase, 400 V) (kW)	Ordering No.	Weight (g)	Packaging (pcs)
MS32-0.16	0.1 ... 0.16		30.108.757	279	1
MS32-0.25	0.16 ... 0.25	0.06	30.108.758	279	1
MS32-0.4	0.25 ... 0.4	0.09	30.108.759	279	1
MS32-0.63	0.4 ... 0.63	0.12 ... 0.18	30.108.760	279	1
MS32-1	0.63 ... 1	0.18 ... 0.25	30.108.761	279	1
MS32-1.6	1 ... 1.6	0.37 ... 0.55	30.108.762	279	1
MS32-2.5	1.6 ... 2.5	0.75	30.108.763	279	1
MS32-4	2.5 ... 4	1.1 ... 1.5	30.108.764	279	1
MS32-6.3	4 ... 6.3	2.2	30.108.765	279	1
MS32-10	6.3 ... 10	3 ... 4	30.108.766	279	1
MS32-14	9 ... 14	5.5	30.108.767	279	1
MS32-18	13 ... 18	7.5	30.108.768	279	1
MS32-23	17 ... 23	9 ... 11	30.108.769	279	1
MS32-27	23 ... 27	11	30.108.770	279	1
MS32-32	25 ... 32	15	30.108.771	279	1



Circuit breakers for transformer protection MS32TR

with overload and short-circuit release

AC-3 acc. to IEC/EN 60947-4-1

Type	Setting range (A)	Ordering No.	Weight (g)	Packaging (pcs)
MS32TR-2.5	1.6 ... 2.5	30.109.359	279	1
MS32TR-4	2.5 ... 4	30.109.360	279	1
MS32TR-6.3	4 ... 6.3	30.109.361	279	1
MS32TR-10	6.3 ... 10	30.109.362	279	1
MS32TR-14	9 ... 14	30.109.363	279	1
MS32TR-18	13 ... 18	30.109.364	279	1
MS32TR-23	17 ... 23	30.109.365	279	1
MS32TR-27	23 ... 27	30.109.366	279	1
MS32TR-32	25 ... 32	30.109.367	279	1



Motor protection circuit breakers MS18

with overload and short-circuit release

AC-3 acc. to IEC/EN 60947-4-1

Type	Setting range (A)	Motor power (3-phase, 400 V) (kW)	Ordering No.	Weight (g)	Packaging (pcs)
MS18-0.16	0.1 ... 0.16		30.109.119	279	1
MS18-0.25	0.16 ... 0.25	0.06	30.109.120	279	1
MS18-0.4	0.25 ... 0.4	0.09	30.109.121	279	1
MS18-0.63	0.4 ... 0.63	0.12 ... 0.18	30.109.122	279	1
MS18-1	0.63 ... 1	0.18 ... 0.25	30.109.123	279	1
MS18-1.6	1 ... 1.6	0.37 ... 0.55	30.109.124	279	1
MS18-2.5	1.6 ... 2.5	0.75	30.109.125	279	1
MS18-4	2.5 ... 4	1.1 ... 1.5	30.109.126	279	1
MS18-6.3	4 ... 6.3	2.2	30.109.127	279	1
MS18-10	6.3 ... 10	3 ... 4	30.109.128	279	1
MS18-14	9 ... 14	5.5	30.109.129	279	1
MS18-18	13 ... 18	7.5	30.109.130	279	1



Ordering data

MS32 - 4

Setting range (A)

Type

Example:

The same switch with under-voltage release for control voltage 380 V with an auxiliary switch with two NO contacts, built in the enclosure, with an emergency stop push-button and green signal lamp for 230 V:



MS32 - 4 / UR 380 / HS 20 / HO41 / NAT / SSz 230

Motor Protection Circuit Breakers

Accessories - MS32, MS18

Auxiliary contact block HSV

AC-15, DC-13 acc. to IEC/EN 60947-5-1



Type	Number of contacts		Wiring diagram	Ordering No.	Weight (g)	Packaging (pcs)
	NO	NC				
HSV10	1	0		38.902.521	32	1
HSV01	0	1		38.902.520	32	1



- HSV contact changes position from its normal state when the MS32/MS18 MPCB is switched on.

Trip-indicating contact block HRS

AC-15, DC-13 acc. to IEC/EN 60947-5-1



Type	Number of contacts		Wiring diagram	Ordering No.	Weight (g)	Packaging (pcs)
	NO	NC				
HRS10	1	0		38.902.523	32	1
HRS01	0	1		38.902.522	32	1



- HRS contact changes position from its normal state when the MS32/MS18 MPCB trips due to overload, short-circuit or manual depression of the TEST lever.

Auxiliary contact block for lateral mounting HS

AC-15, DC-13 acc. to IEC/EN 60947-5-1

Type	Number of contacts		Wiring diagram	Ordering No.	Weight (g)	Packaging (pcs)
	NO	NC				
HS10	1	0		38.902.456	32	1
HS11	1	1		38.902.458	32	1
HS20	2	0		38.902.460	32	1



Adapters for connection of MS32/MS18 with a contactor

Type	Used for	Ordering No.	Weight (g)	Packaging (pcs)
MSK07	K07	30.018.211	10	10
MSKNL9	KNL9 ... KNL18	30.018.212	10	10
MSKNL22	KNL22 ... KNL30	30.018.213	10	10



Under-voltage release UR

Voltage (V)*	Frequency (Hz)	Ordering No.	Weight (g)	Packaging (pcs)
24	50	38.902.534	62	1
24	60	38.902.535	62	1
110	50	38.902.941	62	1
110	60	38.902.536	62	1
230	50	38.902.461	62	1
230	60	38.902.943	62	1
240	50	38.902.524	62	1
240	60	38.902.537	62	1
400	50	38.902.634	62	1
400	60	38.902.947	62	1
415	50	38.902.533	62	1
415	60	38.902.949	62	1
480	50	38.902.951	62	1
480	60	38.902.538	62	1
500	50	38.902.952	62	1
500	60	38.902.939	62	1
600	50	38.902.954	62	1
600	60	38.902.539	62	1

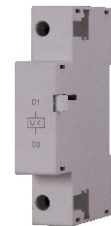

Shunt release AR

Voltage (V)*	Frequency (Hz)	Ordering No.	Weight (g)	Packaging (pcs)
24	50	38.902.574	62	1
24	60	38.902.575	62	1
110	50	38.902.940	62	1
110	60	38.902.576	62	1
230	50	38.902.462	62	1
230	60	38.902.942	62	1
240	50	38.902.525	62	1
240	60	38.902.944	62	1
400	50	38.902.945	62	1
400	60	38.902.946	62	1
415	50	38.902.573	62	1
415	60	38.902.948	62	1
480	50	38.902.950	62	1
480	60	38.902.578	62	1
500	50	38.902.579	62	1
500	60	38.902.938	62	1
600	50	38.902.953	62	1
600	60	38.902.955	62	1



* UR and AR releases for other control voltage/frequencies are on request.

Enclosures for MS32/MS18

Type	Degree of protection	Ordering No.	Weight (g)	Packaging (pcs)
Enclosure HO-41	IP41	38.423.019	222	1
Enclosure HO-55	IP55	38.423.020	222	1
Frame FP-41	IP41	38.423.111	158	1
Frame FP-55	IP55	38.423.112	158	1
Front plate P-41	IP41	37.425.102	200	1
Front plate P-55	IP55	38.423.137	200	1



P-41/55



FP-41/55



HO-41/55

Motor Protection Circuit Breakers

Accessories - MS32, MS18

Accessories for enclosures HO-41/55, FP-41/55, P-41/55

Type	Voltage	Ordering No.	Weight (g)	Packaging (pcs)
Emergency stop push-button E	/	38.902.528	40	1
Emergency stop push-button with keylock E-K	/	38.902.530	40	1
Padlocking feature HZ	/	38.423.095	95	1
Push-button diaphragm IP55	/	38.423.113	12	1
Neutral link NL	/	38.552.076	525	25
Signal lamp SSr (Red)	250 V 400 V	623.000.131 623.009.261	175	25
Signal lamp SSz (Green)	250 V 400 V	623.009.257 623.009.262	175	25
Signal lamp SSb (Transparent)	250 V 400 V	623.009.256 623.009.263	175	25
Cable inlet M25 x 1.5	/	315.609.520	15	100



Motor protection circuit-breakers areas of use

Type	Motor protection	Overload protection	Short-circuit protection	Single-phase consumers	Transformer protection
MS25	■	■	■	■	
MST25	■	■		■	
MS20	■	■	■	■	
MS25-TR		■	■		■
MSZ25			■	■	
MPE				■	

Motor protection circuit breakers MS25

with overload and short-circuit release

AC-3 acc. to IEC/EN 60947-4-1

Type	Setting range (A)	Motor power (3-phase, 400 V) (kW)	Ordering No.	Weight (g)	Packaging (pcs)
MS25-0.16	0.1 ... 0.16	0.02	30.107.955	252	1
MS25-0.25	0.16 ... 0.25	0.06	30.107.956	252	1
MS25-0.4	0.25 ... 0.4	0.09	30.107.957	252	1
MS25-0.63	0.4 ... 0.63	0.12	30.107.958	252	1
MS25-1	0.63 ... 1	0.18 ... 0.25	30.107.959	252	1
MS25-1.6	1 ... 1.6	0.37 ... 0.55	30.107.960	252	1
MS25-2.5	1.6 ... 2.5	0.75 ... 1.1	30.107.961	252	1
MS25-4	2.5 ... 4	1.1 ... 1.5	30.107.962	252	1
MS25-6.3	4 ... 6.3	2.2 ... 2.5	30.107.963	252	1
MS25-10	6.3 ... 10	3 ... 4	30.107.964	252	1
MS25-16	10 ... 16	5 ... 7.5	30.107.965	252	1
MS25-20	16 ... 20	9	30.107.966	252	1
MS25-25	20 ... 25	11 ... 12.5	30.107.967	252	1



Motor protection circuit breakers MST25

with overload release

AC-3 acc. to IEC/EN 60947-4-1

Type	Setting range (A)	Motor power (3-phase, 400 V) (kW)	Ordering No.	Weight (g)	Packaging (pcs)
MST25-0.4	0.25 ... 0.4	0.09	30.108.240	252	1
MST25-0.63	0.4 ... 0.63	0.12	30.108.241	252	1
MST25-1	0.63 ... 1	0.18 ... 0.25	30.108.242	252	1
MST25-1.6	1 ... 1.6	0.37 ... 0.55	30.108.243	252	1
MST25-2.5	1.6 ... 2.5	0.75 ... 1.1	30.108.244	252	1
MST25-4	2.5 ... 4	1.1 ... 1.5	30.108.245	252	1
MST25-6.3	4 ... 6.3	2.2 ... 2.5	30.108.246	252	1
MST25-10	6.3 ... 10	3 ... 4	30.108.247	252	1
MST25-16	10 ... 16	5 ... 7.5	30.108.248	252	1
MST25-20	16 ... 20	9	30.108.249	252	1
MST25-25	20 ... 25	11 ... 12.5	30.108.250	252	1



Motor Protection Circuit Breakers

MS25



Motor protection circuit breakers MS20

with overload and short-circuit release

AC-3 acc. to IEC/EN 60947-4-1

Type	Setting range (A)	Motor power (single-phase, 220-240 V) (kW)	Ordering No.	Weight (g)	Packaging (pcs)
MS20-0.16	0.1 ... 0.16	–	30.108.523	252	1
MS20-0.25	0.16 ... 0.25	–	30.108.524	252	1
MS20-0.4	0.25 ... 0.4	–	30.108.525	252	1
MS20-0.63	0.4 ... 0.63	–	30.108.526	252	1
MS20-1	0.63 ... 1	0.06 ... 0.09	30.108.527	252	1
MS20-1.6	1 ... 1.6	0.12	30.108.528	252	1
MS20-2.5	1.6 ... 2.5	0.18 ... 0.25	30.108.529	252	1
MS20-4	2.5 ... 4	0.37	30.108.513	252	1
MS20-6.3	4 ... 6.3	0.55 ... 0.75	30.108.514	252	1
MS20-10	6.3 ... 10	1.1 ... 1.5	30.108.515	252	1
MS20-16	10 ... 16	2.2	30.108.516	252	1
MS20-20	16 ... 20	3	30.108.517	252	1



Circuit breakers for single-phase consumers MPE

with overload and short-circuit release

AC-3 acc. to IEC/EN 60947-4-1

Type	Setting range (A)	Motor power (3-phase, 400 V) (kW)	Ordering No.	Weight (g)	Packaging (pcs)
MPE	0.25	0.06	30.107.879	252	1



Circuit breakers for short-circuit protection MSZ25

with short-circuit release

Type	Setting range (A)	Motor power (3-phase, 400 V) (kW)	Ordering No.	Weight (g)	Packaging (pcs)
MSZ25-0.16	–	0.02	30.109.357	252	1
MSZ25-0.25	–	0.06	30.109.358	252	1



Circuit breakers for transformer protection MS25TR

with overload and short-circuit release

AC-6a acc. to IEC/EN 60947-4-1

Type	Setting range (A)	Ordering No.	Weight (g)	Packaging (pcs)
MS25TR-2.5	1.6 ... 2.5	30.109.368	252	1
MS25TR-4	2.5 ... 4	30.109.369	252	1
MS25TR-6.3	4 ... 6.3	30.109.370	252	1
MS25TR-10	6.3 ... 10	30.109.371	252	1
MS25TR-16	10 ... 16	30.109.372	252	1
MS25TR-20	16 ... 20	30.109.373	252	1
MS25TR-25	20 ... 25	30.109.374	252	1



Ordering data







Example:

The same switch with under-voltage release for control voltage 380 V with an auxiliary switch with two NO contacts, built in the enclosure, with an emergency stop push-button and green signal lamp for 230 V:

MS25 - 4 / U 380 / PS 20 / O41 / NAT / SSz 230

Auxiliary contact block for lateral mounting PS

Type	Number of contacts		Wiring diagram	Ordering No.	Weight (g)	Packaging (pcs)
	NO	NC				
PS01	0	1		38.901.670	35	1
PS10	1	0		38.901.669	35	1
PS11	1	1		38.901.501	35	1
PS20	2	0		38.901.500	35	1



Under-voltage release U

Voltage (V)*	Frequency (Hz)	Ordering No.	Weight (g)	Packaging (pcs)
24	50	38.901.502	62	1
24	60	38.901.952	62	1
48	50	38.901.904	62	1
48	60	38.902.956	62	1
60	50	38.901.504	62	1
110	50	38.901.505	62	1
110	60	38.901.726	62	1
120	50	38.903.035	62	1
120	60	38.901.871	62	1
230	50	38.901.506	62	1
230	60	38.902.958	62	1
400	50	38.901.508	62	1
400	60	38.902.960	62	1
415	50	38.902.962	62	1
415	60	38.902.964	62	1
480	50	38.902.966	62	1
480	60	38.901.863	62	1
500	50	38.902.968	62	1
500	60	38.902.970	62	1
600	50	38.902.972	62	1
600	60	38.901.870	62	1



Shunt release A

Voltage (V)*	Frequency (Hz)	Ordering No.	Weight (g)	Packaging (pcs)
24	50	38.901.510	62	1
24	60	38.901.953	62	1
48	50	38.901.905	62	1
48	60	38.902.957	62	1
110	50	38.901.513	62	1
110	60	38.901.727	62	1
120	50	38.901.973	62	1
120	60	38.901.871	62	1
230	50	38.901.514	62	1
230	60	38.902.959	62	1
400	50	38.901.516	62	1
400	60	38.902.961	62	1
415	50	38.902.963	62	1
415	60	38.902.965	62	1
480	50	38.902.967	62	1
480	60	38.901.864	62	1
500	50	38.902.969	62	1
500	60	38.902.971	62	1
600	50	38.902.973	62	1
600	60	38.901.872	62	1

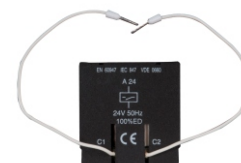



* U and A releases for other control voltage/frequencies are on request.

Motor Protection Circuit Breakers

Accessories - MS25

Trip-indicating auxiliary contact block RS

Type	Number of contacts		Wiring diagram	Ordering No.	Weight (g)	Packaging (pcs)
	NO	NC				
RS01	0	1		38.902.149	35	1
RS10	1	0		38.902.150	35	1



- RS contact changes position from its normal state when the MS25 MPCB trips due to overload, short-circuit or the manual depression of the TEST lever.

Adapters for connection of MS25 with a contactor

Type	Conductor length (mm)	Conductor cross-section (mm ²)	Thermal current (A)	Ordering No.	Weight (g)	Packaging (pcs)
DST-U-2.5	40	2.5	20	665.200.020	12	10
DST-U-4	40	4	35	665.200.021	16	10
DST-U-2.5 L	70	2.5	20	665.200.022	14	10



Enclosures for MS25

Type	Degree of protection	Ordering No.	Weight (g)	Packaging (pcs)
Enclosure O-41	IP41	38.422.509	222	1
Enclosure O-55	IP55	38.422.510	222	1
Front plate CP-41	IP41	38.422.035	150	1
Front plate CP-55	IP55	38.421.994	150	1



CP-41/55



O-41/55

Accessories for enclosures O-41/55 and CP-41/55

Type	Voltage	Ordering No.	Weight (g)	Packaging (pcs)
Emergency stop push-button NAT	/	38.901.665	40	1
Emergency stop push-button with keylock NAT-K	/	38.902.488	40	1
Padlocking feature Z	/	38.901.632	95	1
Push-button diaphragm IP55	/	38.422.130	12	1
Neutral link NL	/	38.552.076	525	25
Signal lamp SSr (Red)	250 V 400 V	623.000.131 623.009.261	175	25
Signal lamp SSz (Green)	250 V 400 V	623.009.257 623.009.262	175	25
Signal lamp SSb (Transparent)	250 V 400 V	623.009.256 623.009.263	175	25
Cable inlet M25 x 1.5	/	315.609.520	15	100



Motor Protection Circuit Breakers Accessories

Connection blocks MSS-3L

Type	Number of MPCB	Length (mm)	Ordering No.	Weight (g)	Packaging (pcs)
MSS-3L-M2-45	2	80	655.200.001	26	10
MSS-3L-M3-45	3	125	655.200.002	48	10
MSS-3L-M4-45	4	170	655.200.003	68	10
MSS-3L-M5-45	5	215	655.200.004	90	10
MSS-3L-M2 + Hi-45 + 9	2	90	655.200.005	30	10
MSS-3L-M3 + Hi-45 + 9	3	145	655.200.006	54	10
MSS-3L-M4 + Hi-45 + 9	4	200	655.200.007	78	10
MSS-3L-M5 + Hi-45 + 9	5	250	655.200.008	111	10



MSS-3L-Mx-45 connection blocks

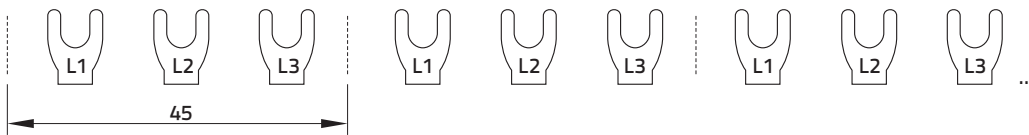

MSS-3L-Mx-45 + 9 connection blocks (for MPCB with side-mounted accessories)

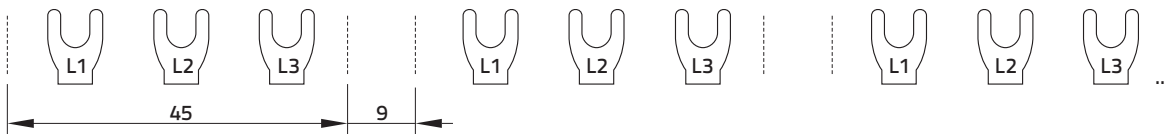

Supply block (25 mm²)

Type	Ordering No.	Weight (g)	Packaging (pcs)
ESB-S/V-MS	655.200.009	40	10

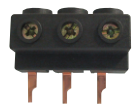

Protection for connection cable

Type	Ordering No.	Weight (g)	Packaging (pcs)
BS-MS 0	655.200.010	2	10





Technical characteristics

Dimensions



Motor Protection Circuit Breakers

MS32, MS18



TECHNICAL DATA

Type	Symbol	Unit	MS32	MS18
Use			motor protection	
Standards			IEC/EN 60947-2, IEC/EN 60947-4-1, IEC/EN 60204, UL 60947 CSA 22.2 No. 14	IEC/EN 60947-2, IEC/EN 60947-4-1, IEC/EN 60204, UL 60947 CSA 22.2 No. 14
Approvals			CE, UL, EAC	CE
Climatic class			Constant damp heat acc. to IEC 60068-2-78 Cyclic damp heat acc. to IEC 60068-2-30	
Degree of protection			IP20, after terminals covering IP40	
Mounting			35 mm DIN rail (EN 60715)	
Mounting position			any	
Ambient temperature		°C	-25 ... +60	
Storage temperature		°C	-25 ... +70	
Temperature range of thermal compensation		°C	-5 ... +40	
Maximum altitude (MSL) *		m	2000	
Mechanical endurance		op. c.	100.000	
Electrical endurance		op. c.	100.000 (AC-3), 20.000 (DC-5)	
Trip class acc. to IEC 60947-4-1			10	
Utilization category acc. to IEC 60947-4-1			AC-3	
Utilization category acc. to IEC 60947-2			A	
Max. switching frequency		op. c./h	25	
Shock resistance acc. to IEC 68-2-27		g	20	
Vibration resistance acc. to IEC 68-2-6		g	5 (at f= 5 ... 150 Hz)	
Overvoltage category			III	
Pollution degree			3	
Rated insulation voltage	U_i	V	690	
Rated impulse withstand voltage	U_{imp}	kV	6	
Weight		g	279	
Terminal capacity:				
rigid	S	mm ²	1 ... 10	
flexible			1 ... 6	
flexible with end sleeve			0.75 ... 6	
Conductor insulation stripping length		mm	10	
Screw			M3	
Screw type			PZ2, with self-lifting clamp protected from falling out	
Tightening torque		Nm	2,0	
Nominal current	I_n	A	0.16, 0.25, 0.4, 0.63, 1, 1.6, 2.5, 6.3, 10, 14, 18, 23, 27, 32	0.16, 0.25, 0.4, 0.63, 1, 1.6, 2.5, 6.3, 10, 14, 18
Current setting	I_T	A	0.1-0.16, 0.16-0.25, 0.25-0.4, 0.4-0.63, 0.63-1, 1-1.6, 1.6-2.5, 2.4-4, 4-6.3 6.3-10, 9-14, 13-18, 17-23, 20-27, 25-32	0.1-0.16, 0.16-0.25, 0.25-0.4, 0.4-0.63, 0.63-1, 1-1.6, 1.6-2.5, 2.4-4, 4-6.3 6.3-10, 9-14, 13-18
Nominal current range	I_n	A	0.16 ... 32	0.16 ... 18
Nominal frequency	f	Hz	50/60	
Max. operational voltage	U_e	V	690	
Thermal current	I_{th}	A	32	18
Max. motor current AC-3		A	32	18
Number of all poles			3	
Number of protected poles			3	
Contact gap (per pole)		mm	9.2	
Release type			thermal-magnetic	
Operating current of thermal overload release			1.05 I_n , < $I \leq 1.2 I_n$	
Operating current of magnetic release (fixed)			12 $I_n \pm 20\%$	
Sensitivity to phase failure			yes	
Power dissipation at I_n (all poles)		W	6 ... 7.5	
MTTF - Mean time to failure		h	1666	
MTTF _d - Mean time to failure dangerous		h	5000	
MTTF _d = 1/λ _d = B10 _d /(0.1 n _{op})				
B10 - Number of operating cycles until 10 % of devices fail		op.	20.000	
B10 _d - Number of operating cycles until 10 % of device dangerous		op.	60.000	
B10 _d = B10/ratio of dangerous failures				
λ - Failure rate		1/h	6 x 10 ⁻⁴	
λ = (0,1 n _{op})/B10				
λ - Failure rate dangerous		1/h	2 x 10 ⁻⁴	
λ _d = (0,1 n _{op})/B10 _d				
Ratio of dangerous failures		%	33	
n _{op} - Operating cycles (operating cycles/h)		op./h	120	

* NOTE: Above 2000 m voltages U_i and U_e are reduced by 2% for every 100 m and current I_n by 2% for every 500 m.

Switch selection for motor protection

Standard motor powers						Setting range
Single-phase	Three-phase					
220 V 230 V 240 V	220 V 230 V 240 V	380 V 400 V 415 V	440 V	550 V	660 V 690 V	
kW						A
		0.06	0.06	0.06 ... 0.9	0.06 ... 0.12	0.1 ... 0.16
	0.06	0.09	0.12	0.09 ... 0.12	0.18	0.16 ... 0.25
	0.09	0.12 ... 0.18	0.18	0.18	0.25	0.25 ... 0.4
0.06 ... 0.09	0.09 ... 0.12	0.18 ... 0.25	0.25 ... 0.37	0.25 ... 0.37	0.37 ... 0.55	0.4 ... 0.63
0.12	0.18 ... 0.25	0.37 ... 0.55	0.37 ... 0.55	0.55 ... 0.75	0.75 ... 1.1	0.63 ... 1
0.18 ... 0.25	0.37	0.75	0.75 ... 1.1	1.1	1.5	1 ... 1.6
0.37	0.55 ... 0.75	1.1 ... 1.5	1.5	1.5 ... 2.2	2.2 ... 3	1.6 ... 2.5
0.55 ... 0.75	1.1 ... 1.5	2.2	2.2 ... 3	2.2 ... 3	4	2.5 ... 4
1.1 ... 1.5	1.5 ... 2.2	3 ... 4	4	4 ... 5.5	5.5 ... 7.5	4 ... 6.3
2.2	2.2 ... 3	5.5	5.5 ... 7.5	5.5 ... 7.5	9 ... 11	6.3 ... 10
3	4	7.5	7.5 ... 9	9 ... 11	15	9 ... 14
	5.5	9 ... 11	11	11	15 ... 18.5	13 ... 18
	5.5 ... 7.5	11	11	15	18.5 ... 22	17 ... 23
	7.5	15	15	18.5	22	20 ... 27
						25 ... 32

MS32 motor protection switches, rated ultimate and service short-circuit breaking capacity I_{cu} and I_{cs} and max. back-up fuses if short circuit current I_{cp} exceeds I_{cu}

Type	Operating current of short-circuit release (A)	Rated ultimate short-circuit breaking capacity I_{cu} , I_{cs} (kA)								Max. back-up fuse, if $I_{cp} > I_{cu}$ (gL) (kA)						
		230 V		400 V		500 V		690 V		230 V	400 V	500 V	690 V			
		I_{cu}	I_{cs}	I_{cu}	I_{cs}	I_{cu}	I_{cs}	I_{cu}	I_{cs}							
MS32 - 0.16	MS18 - 0.16	2	100	100	100	100	100	100	100	100	No back-up fuse required					
MS32 - 0.25	MS18 - 0.25	3	100	100	100	100	100	100	100	100						
MS32 - 0.4	MS18 - 0.4	5	100	100	100	100	100	100	100	100						
MS32 - 0.63	MS18 - 0.63	8	100	100	100	100	100	100	100	100						
MS32 - 1	MS18 - 1	13	100	100	100	100	100	100	100	100						
MS32 - 1.6	MS18 - 1.6	22	100	100	100	100	100	100	100	100						
MS32 - 2.5	MS18 - 2.5	33	100	100	100	100	100	100	5	5					16	
MS32 - 4	MS18 - 4	55	100	100	100	100	100	100	3	3					25	
MS32 - 6.3	MS18 - 6.3	75	100	100	100	100	6	4.5	3	2					35	35
MS32 - 10	MS18 - 10	126	100	100	100	100	6	4.5	3	2					50	35
MS32 - 14	MS18 - 14	170	25	12.5	25	12.5	6	4.5	3	2	80	63	50	50		
MS32 - 18	MS18 - 18	230	25	12.5	25	12.5	6	4.5	3	2	80	63	50	50		
MS32 - 23		270	25	12.5	25	12.5	4	3	3	2	80	63	50	50		
MS32 - 27		360	25	12.5	25	12.5	4	3	3	2	80	63	50	50		
MS32 - 32		400	25	12.5	25	12.5	4	3	3	2	80	63	50	50		

Motor Protection Circuit Breakers

MS32, MS18



Tripping characteristics

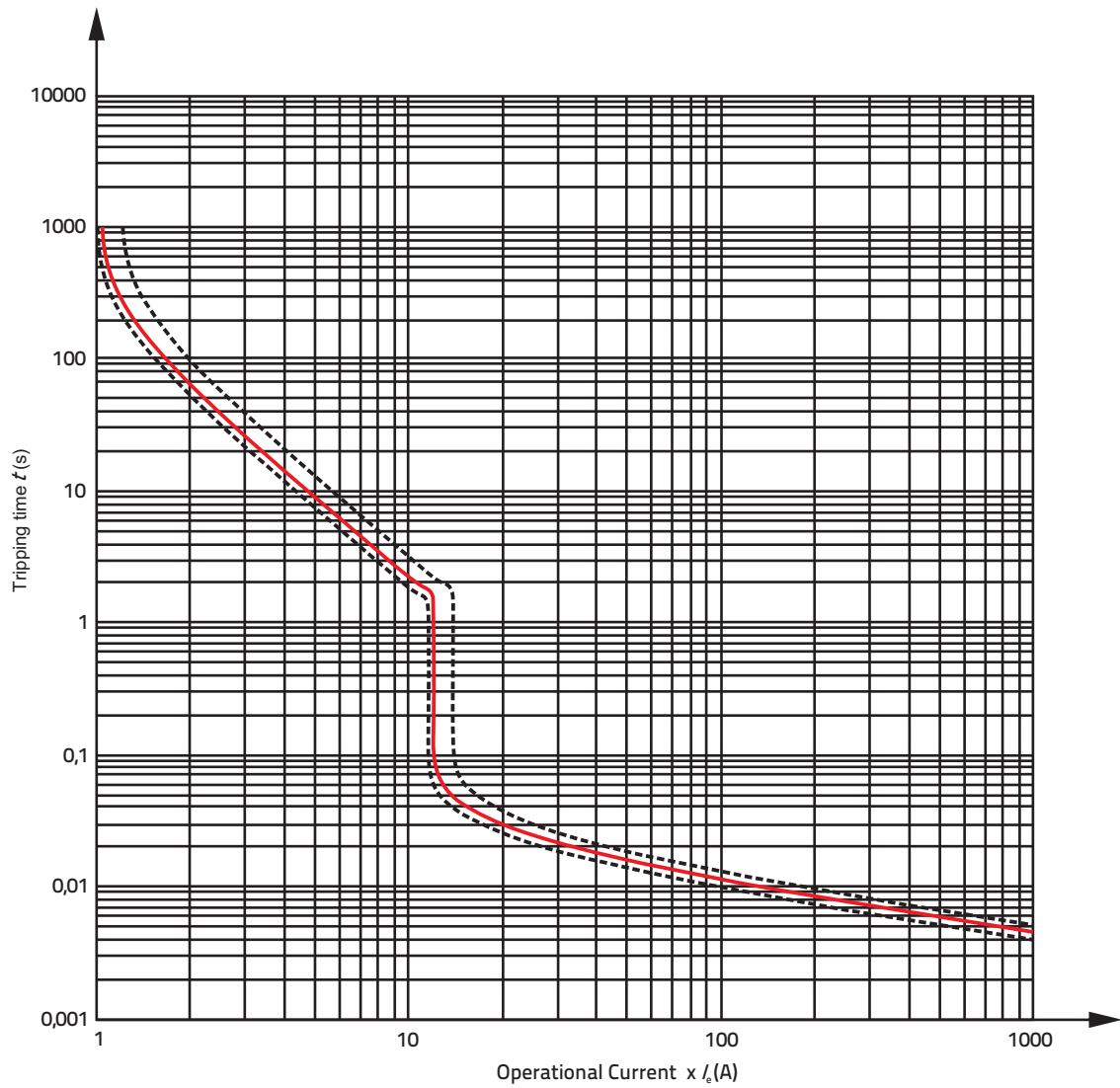

Mounting positions of accessories

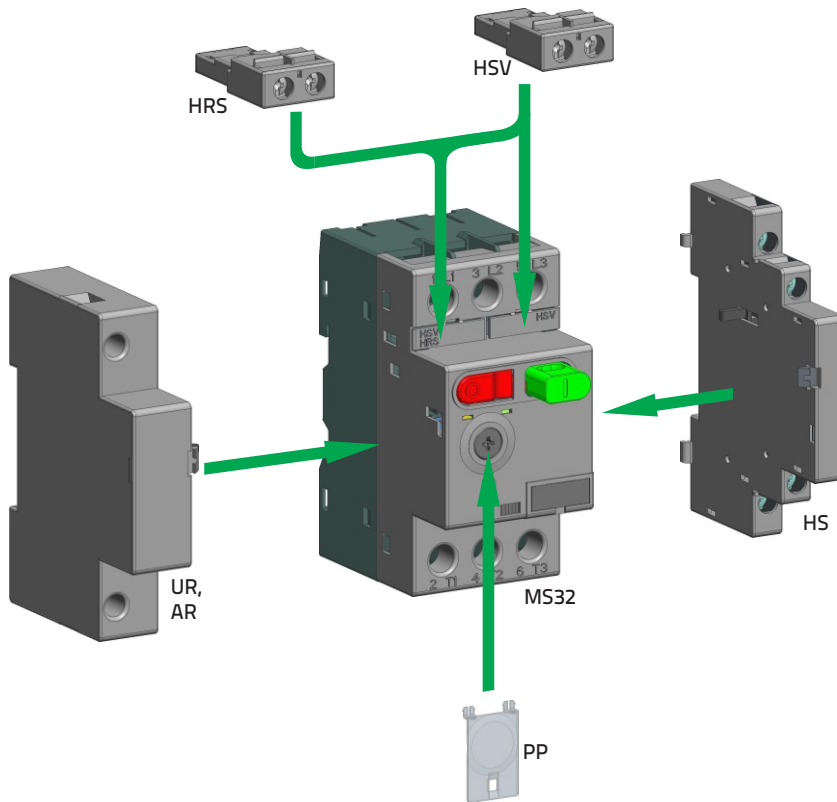

Motor Protection Circuit Breakers

MS32, MS18 - Accessories



Auxiliary switch for side mounting HS

TECHNICAL DATA

Standards			IEC 60947-5-1, UL 60947-5-1
Approvals			CE, UL, EAC
Rated impulse voltage	U_{imp}	V	6 kV
Rated insulation voltage	U_i	V	500
Thermal current	I_{th}	A	5
Rated operational current AC-15 (240 V)	I_e	A	1.5
Rated operational current DC-13 (250 V)	I_e	A	0.1
Contact rating code designation for AC/DC			B300 / R300
Mechanical endurance		op. c.	100.000
Electrical endurance		op. c.	100.000
Terminal capacity	S	mm ²	0.75 ... 2.5
Conductor insulation stripping length		mm	8
Screw type			M3.5
Screw head			PZ2
Tightening torque		Nm	1

Auxiliary contact block HSV, Trip indicating contact block HRS

TECHNICAL DATA

Standards			IEC 60947-5-1, UL 60947-5-1
Approvals			CE, UL, EAC
Rated impulse voltage	U_{imp}	V	6
Rated insulation voltage	U_i	V	300
Thermal current	I_{th}	A	1
Rated operational current AC-15 (240 V)	I_e	A	3
Rated operational current DC-13 (125 V)	I_e	A	0.22
Contact rating code designation for AC/DC			B300 / R300
Mechanical endurance		op. c.	100.000
Electrical endurance		op. c.	100.000
Terminal capacity	S	mm ²	0.75 ... 2.5
Conductor insulation stripping length		mm	8
Screw type			M3.5
Screw head			PZ2
Tightening torque		Nm	0.6

Under-voltage release UR, Shunt release AR

TECHNICAL DATA

Type			UR	AR
Standards			IEC/EN 60947-1, UL 60947-1	
Approvals	U_c	V	CE, UL, EAC	
Control voltages (AC)	U_c	V	24, 110, 230, 240, 400, 415, 480, 500, 600	
Rated frequency	f	Hz	50/60	
Pick-up voltage		x U_c	< 0.85	≤ 0.7
Drop-out voltage			0.7 ... 0.35	0.7 ... 0.15
Power consumption switch-on operation		VA/W	7.9 / 3.9	
switch-on operation			3.3 / 0.9	
Duty cycle	t_{ON}/t_{OFF}	%	100	
Noise level		dB	≤ 35	
Mechanical and electrical endurance		op.	min. 10.000	
Terminal capacity		mm ²	0.75 ... 2.5	
Conductor insulation stripping length		mm	11	
Screw type			M3.5	
Screw head			PZ2	
Tightening torque		Nm	1	

TECHNICAL DATA

Type	Symbol	Unit	MS25	MST25	MS20	MPE	MSZ25	MS25TR
Use			motor protection		single-phase consumer	single-phase AC motors with built-in thermal switch	short-circuit protection	transformer protection
Standards			IEC/EN 60947-4-1, IEC/EN 60947-2, IEC/EN 60204, UL 60947, CSA 22.2 No. 14		IEC/EN 60947-2, IEC/EN 60947-4-1	IEC/EN 60947-2, IEC/EN 60947-4-1	IEC/EN 60947-2	IEC/EN 60947-2
Approvals			CE, UL, EAC		CE, EAC	CE	CE	CE
Climatic class			Constant damp heat acc. to IEC 60068-2-78 Cyclic damp heat acc. to IEC 60068-2-30					
Degree of protection			IP20, after terminals covering IP40					
Mounting			35 mm DIN rail (EN 60715)					
Mounting position			any					
Ambient temperature		°C	-25 ... +60					
Storage temperature		°C	-25 ... +70					
Temperature range of thermal compensation		°C	-5 ... +40					
Maximum altitude (MSL) *		m	2000					
Mechanical endurance		op. c.	100.000					
Electrical endurance		op. c.	100.000 (AC-3), 20.000 (DC-5)		100.000 (AC-3)	100.000 (AC-3), 20.000 (DC-5)		
Trip class acc. to IEC 60947-4-1			10A	10A	10A	10A	/	10A
Utilization category acc. to IEC 60947-4-1			AC-3, DC-5	AC-3, DC-5	AC-3, DC-5	AC-3	AC-3, DC-5	AC-3, DC-5
Utilization category acc. to IEC 60947-2			A					
Max. switching frequency		op. c./h	25					
Shock resistance acc. to IEC 68-2-27		g	20					
Vibration resistance acc. to IEC 68-2-6		g	5 (at f = 5 ... 150 Hz)					
Overvoltage category			III					
Pollution degree			3					
Rated insulation voltage	U_i	V	690	400	690	250	400	690
Rated impulse withstand voltage	U_{imp}	kV	6					
Weight		g	252					
Terminal capacity:								
rigid	S	mm ²	1 ... 6					
flexible			1 ... 4					
flexible with end sleeve			0.75 ... 4					
Conductor insulation stripping length		mm	10					
Screw			M3					
Screw type			PZ2, with self-lifting clamp protected from falling out					
Tightening torque		Nm	1.8					
Nominal current	I_n	A	0.16, 0.25, 0.4, 0.63, 1, 1.6, 2.5, 4, 6.3, 10, 16, 20, 25	0.4, 0.63, 1, 1.6, 2.5, 4, 6.3, 10, 16, 20, 25	0.16, 0.25, 0.4, 0.63, 1, 1.6, 2.5, 4, 6.3, 10, 16, 20, 25	0.4 ... 10	0.16, 0.25	2.5, 4, 6.3, 10, 16, 20, 25
Current setting	I_T	A	0.1-0.16, 0.16-0.25, 0.25-0.4, 0.4-0.63, 0.63-1, 1-1.6, 1.6-2.5, 2.5-4, 4-6.3, 6.3-10, 10-16, 16-20, 20-25	0.25-0.4, 0.4-0.63, 0.63-1, 1-1.6, 1.6-2.5, 2.5-4, 4-6.3, 6.3-10, 10-16, 16-20, 20-25	0.1-0.16, 0.16-0.25, 0.25-0.4, 0.4-0.63, 0.63-1, 1-1.6, 1.6-2.5, 2.5-4, 4-6.3, 6.3-10, 10-16, 16-20, 20-25	fixed	fixed	2.5-4, 4-6.3, 6.3-10, 10-16, 16-20, 20-25
Nominal current range	I_n	A	0.16 ... 25	0.4 ... 25	0.16 ... 20	0.4 ... 10	0.16 ... 0.25	2.5 ... 25
Nominal frequency	f	Hz	50/60					
Max. operational voltage	U_e	V	690	400	690	250	400	690
Thermal current	I_{th}	A	25**	25**	20**	10	0.25	25
Max. motor current AC-3		A	25	25	20	/	/	/
Max. motor current DC-5 (max. 250 V DC, all poles in series)		A	25	25	20	0.25	0.25	25
Number of all poles			3	3	1	1	3	3
Number of protected poles			3	3	1	1	3	3
Contact gap (per pole)		mm	9.5					
Release type			thermal-magnetic	thermal	thermal-magnetic	thermal-magnetic	thermal	thermal-magnetic
Operating current of thermal overload release			$1.05 I_n < I \leq 1.2 I_n$	$1.05 I_n < I \leq 1.2 I_n$	$1.05 I_n < I \leq 1.2 I_n$	/	/	$1.05 I_n < I \leq 1.2 I_n$
Operating current of magnetic release (fixed)			$12 I_n \pm 20\%$		$12 I_n \pm 20\%$	$12 I_n \pm 20\%$	$12 I_n \pm 20\%$	$17 I_n \pm 20\%$
Sensitivity to phase failure			yes	yes	/	/	/	yes
Power dissipation at I_n (all poles)		W	6 ... 7.5	6 ... 7.5	4 ... 5	2 ... 2.5	≈ 0.5	6 ... 7.5

NOTE:

- * Above 2000 m voltages U_i and U_e are reduced by 2% for every 100 m and current I_n by 2% for every 500 m.
- ** Maximum number of MPCBs mounted close together: 3

Motor Protection Circuit Breakers

MS25



TECHNICAL DATA

SAFETY	Type	Symbol	Unit	MS25	MST25	MS20	MPE	MSZ25	MS25TR
	MTTF - Mean time to failure $MTTF = 1/\lambda = B10/(0.1 n_{op})$		h	1666					
	MTTF _d - Mean time to failure dangerous $MTTF_d = 1/\lambda_d = B10_d/(0.1 n_{op})$		h	5000					
	B10 - Number of operating cycles until 10 % of devices fail		op.	20.000					
	B10 _d - Number of operating cycles until 10 % of device dangerous $B10_d = B10/\text{ratio of dangerous failures}$		op.	60.000					
	λ - Failure rate $\lambda = (0,1 n_{op})/B10$		1/h	6×10^{-4}					
	λ_d - Failure rate dangerous $\lambda_d = (0,1 n_{op})/B10_d$		1/h	2×10^{-4}					
	Ratio of dangerous failures		%	33					
	n_{op} - Operating cycles (operating cycles/h)		op./h	120					

Switch selection for motor protection

Standard motor powers						Setting range
Single-phase	Three-phase					
220 V	220 V	380 V	440 V	550 V	660 V	A
230 V	230 V	400 V				
240 V	240 V	415 V	690 V			
kW						A
		0.02			0.06	0.1 ... 0.16
		0.06	0.06	0.06	0.09	0.16 ... 0.25
	0.06	0.09	0.12	0.12	0.18	0.25 ... 0.4
	0.09	0.12	0.18	0.25	0.25	0.4 ... 0.63
0.06 ... 0.09	0.09 ... 0.12	0.18 ... 0.25	0.25	0.37	0.37 ... 0.55	0.63 ... 1
0.12	0.18 ... 0.25	0.37 ... 0.55	0.37 ... 0.55	0.55 ... 0.8	0.75 ... 1.1	1 ... 1.6
0.18 ... 0.25	0.37	0.75 ... 1.1	0.75 ... 1.1	1.1	1.5	1.6 ... 2.5
0.37	0.55 ... 0.75	1.1 ... 1.5	1.5	1.5 ... 2.2	2.2 ... 3	2.5 ... 4
0.55 ... 0.75	1.1 ... 1.5	2.2 ... 2.5	2.2 ... 3	3	4	4 ... 6.3
1.1 ... 1.5	1.5 ... 2.5	3 ... 4	4 ... 5	4 ... 5.5	5.5 ... 7.5	6.3 ... 10
2.2	3 ... 4	5 ... 7.5	5.5 ... 9	7.5 ... 9	11	10 ... 16
3	5.5	9	11	11 ... 12.5	15	16 ... 20
	5.5 ... 7.5	11 ... 12.5	12.5	15	18.5	20 ... 25

MS25 motor protection switches, rated ultimate and service short-circuit breaking capacity I_{cu} and max. back-up fuses if prospective short circuit current I_{cp} exceeds I_{cu}

Type	Operating current of short-circuit release (A)	Rated ultimate short-circuit breaking capacity I_{cu} I_{cs} (kA)				Max. back-up fuse, if $I_{cp} > I_{cu}$ (gL) (kA)			
		230 V	400 V	500 V	690 V	230 V	400 V	500 V	690 V
MS25 - 0.16	2	50	50	50	50	No back-up fuse required			
MS25 - 0.25	3	50	50	50	50				
MS25 - 0.4	5	50	50	50	50				
MS25 - 0.63	8	50	50	50	50				
MS25 - 1	13	50	50	50	50				
MS25 - 1.6	22	50	50	50	50				
MS25 - 2.5	33	50	50	3	2.5				
MS25 - 4	55	50	50	3	2.5				
MS25 - 6.3	84	50	50	3	2.5				
MS25 - 10	126	50	6	3	2.5				
MS25 - 16	170	6	4	2.5	2	80	80	63	35
MS25 - 20	230	6	4	2.5	2	80	80	63	50
MS25 - 25	270	6	4	2.5	2	80	80	63	50

Tripping characteristics

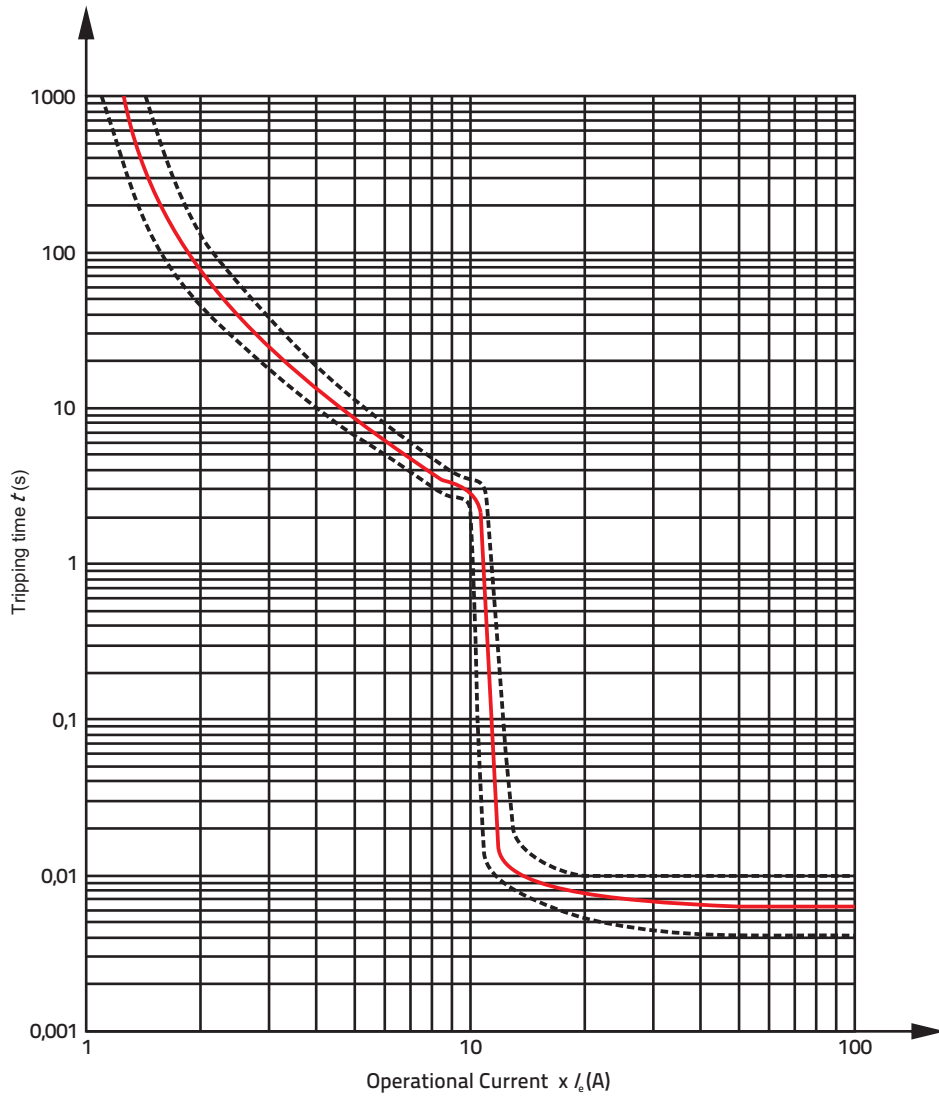

Motor Protection Circuit Breakers

MS25 - Accessories

Mounting positions of accessories

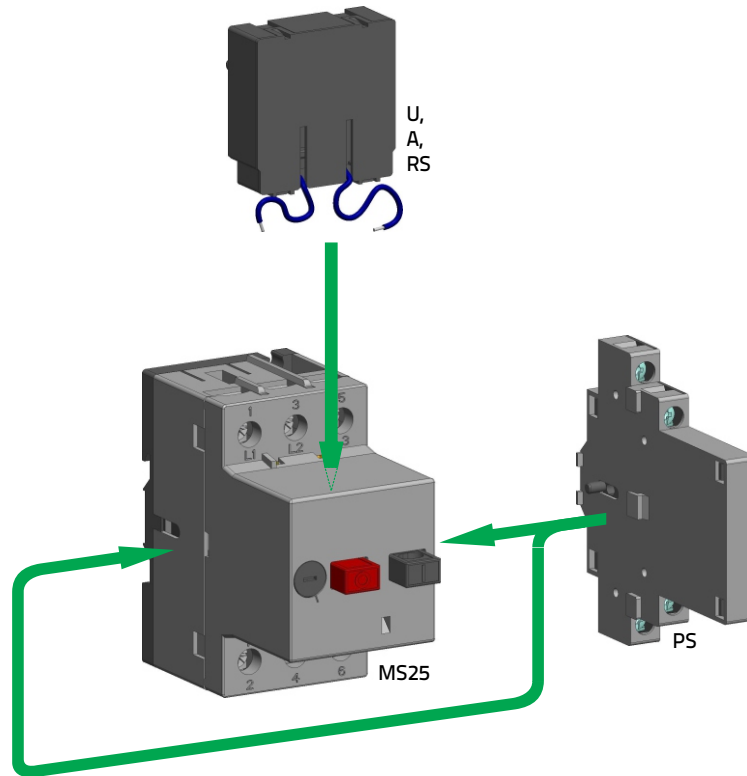

Auxiliary switch for lateral mounting PS

TECHNICAL DATA

Standards			IEC 60947-5-1, UL 60947-5-1
Approvals			CE, UL, EAC
Rated impulse voltage	U_{imp}	kV	6
Rated insulation voltage	U_i	V	500
Thermal current	I_{th}	A	6
Rated operational current AC-15 230 V 400 V 500 V	I_e	A	3.5
			2
			1.5
Mechanical endurance		op. c.	100.000
Terminal capacity	S	mm ²	0.75 ... 2.5
Conductor insulation stripping length		mm	8
Screw type			M3.5
Screw head			PZ2
Tightening torque		Nm	1

Trip-indicating auxiliary switch RS

TECHNICAL DATA

Standards			IEC 60947-5-1, UL 60947-5-1
Approvals			CE, UL, EAC
Rated impulse voltage	U_{imp}	kV	6
Rated insulation voltage	U_i	V	500
Thermal current	I_{th}	A	6
Rated operational current AC-15 230 V 400 V 500 V	I_e	A	3.5
			2
			1.5
Mechanical endurance		op. c.	100.000

Under-voltage release U, Shunt release A

TECHNICAL DATA

Type			U	A
Standard			IEC 60947-5-1, UL 60947-5-1	
Approvals			CE, UL, EAC	
Control voltages (AC)	U_c	V	24, 48, 110, 120, 230, 400, 415, 480, 500, 600	
Rated frequency	f	Hz	50/60	
Pick-up voltage		$\times U_c$	≤ 0.85	
Drop-out voltage			0.7 ... 0.35	
Power consumption switch-on operation switch-on operation		VA/W	7.5 / 4.3	
			3.8 / 1.3	
Duty cycle	t_{ON}/t_{OFF}	%	100	
Noise level		dB	≤ 35	
Mechanical and electrical endurance		op. c.	100.000	

Motor Protection Circuit Breakers

Dimensions

Dimension MS32, MS18

MS32, MS18

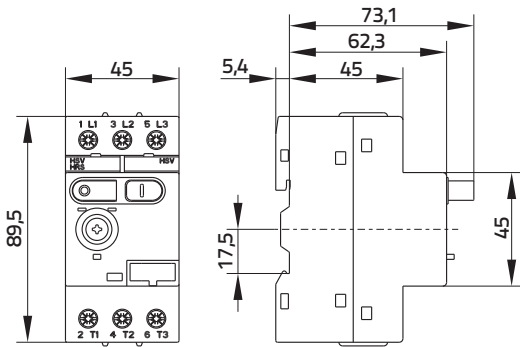

Auxiliary switch HS

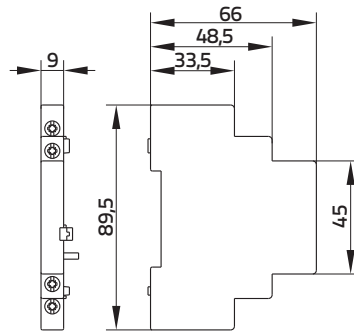

Under-voltage release UR
Shunt release AR

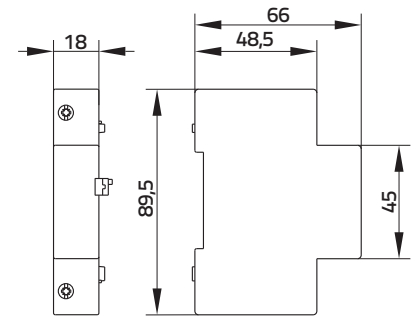

FP-41/55

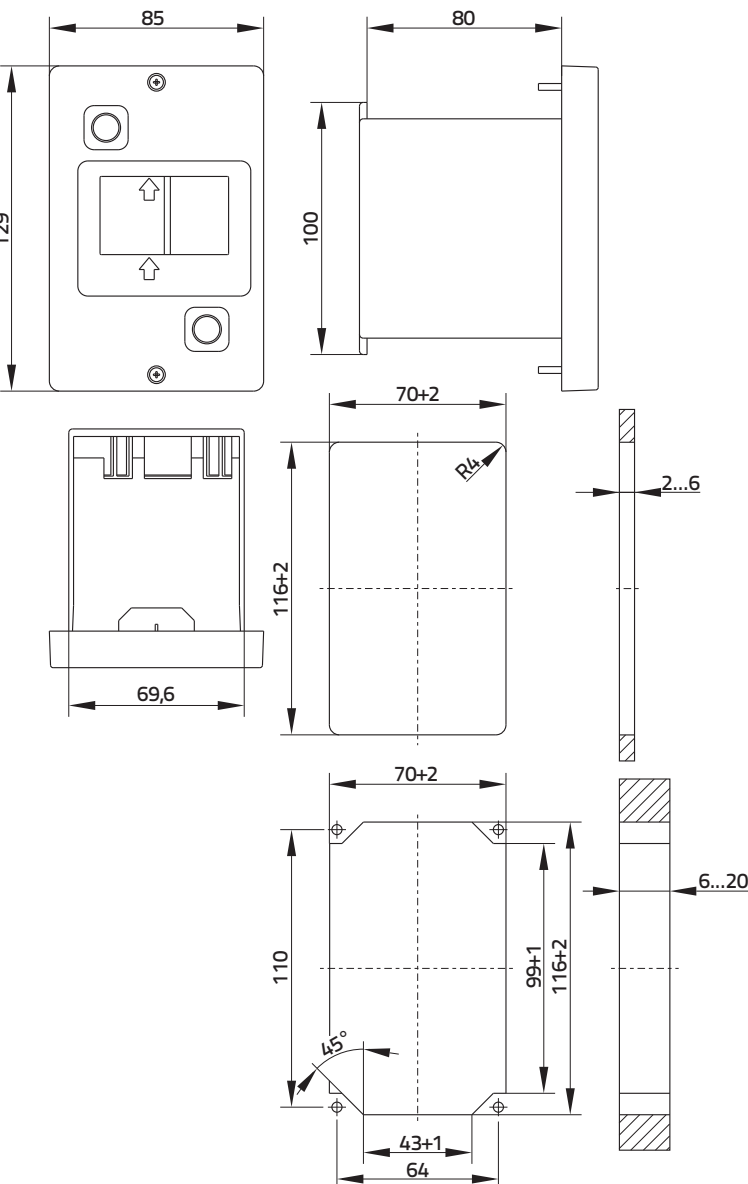

HO-41/55

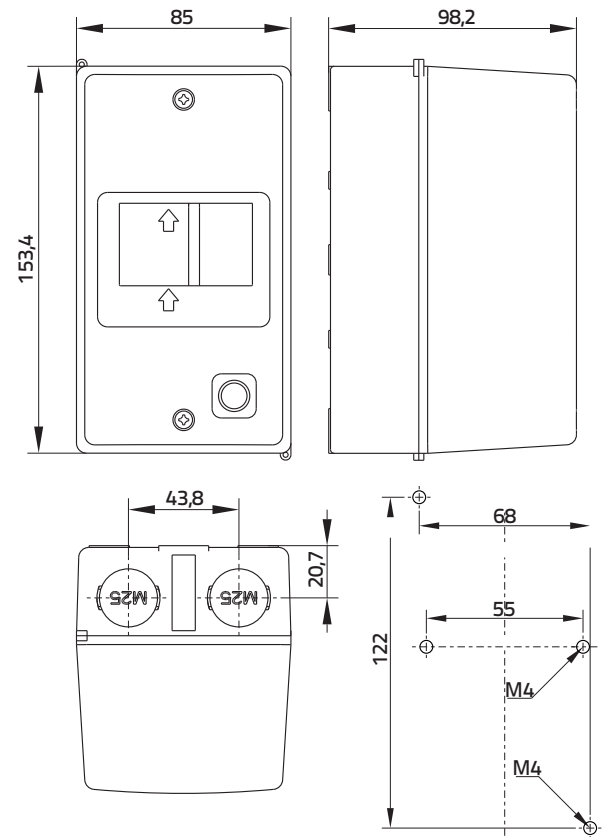

Dimension MS32, MS18

MS25

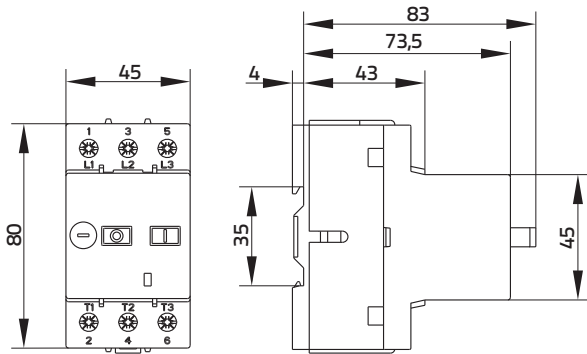

Auxiliary switch PS

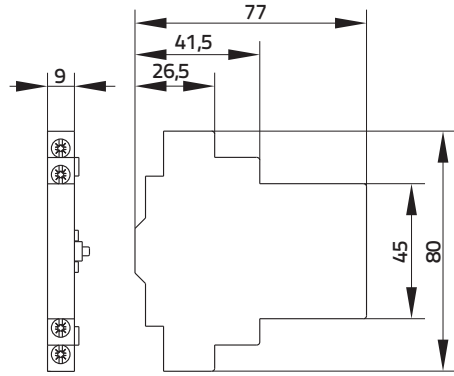

O-41/55

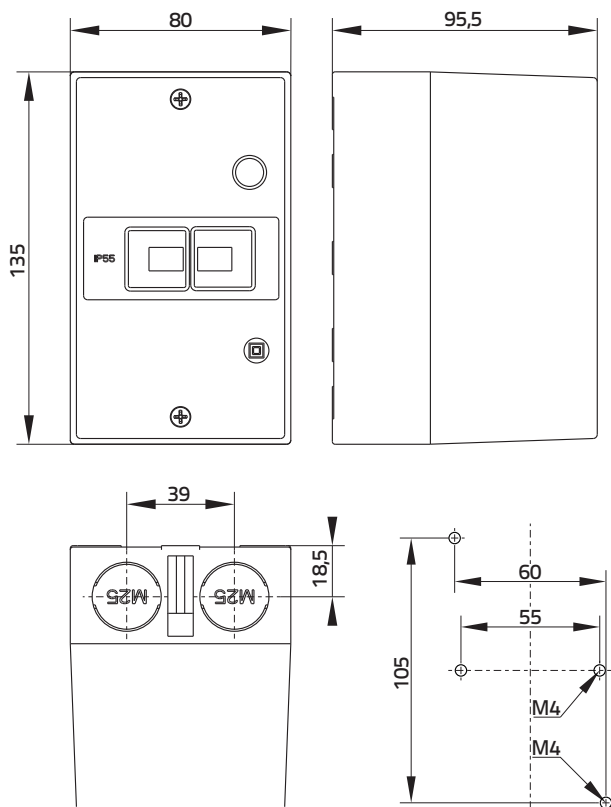

CP-41/55

