

COMMUTATORI

CHANGE-OVER SWITCHES



Contactplasma S.R.L.

RICERCA TECNOLOGICA Elettromeccanica Elettrotecnica BT-MT
L.V.-M.V. ELECTROMECHANICAL AND ELECTROTECHNICS TECHNOLOGICAL RESEARCH

CARATTERISTICHE GENERALI - GENERAL CHARACTERISTICS

GENERALITÀ

Gli apparecchi della serie CKS, CKF, CNQ, CNS, CNP, CNF, DKS, DKF, DNQ, DNS, DNP e DNF sono dei commutatori o deviatori a comando manuale che possono essere a 3-4-6-8 poli. Gli apparecchi della serie BPV e BPD sono by-pass a comando manuale che possono essere a 3-4 poli. Gli apparecchi della serie BPM, BMD, CMF, CKM, CMV, DMF, DKM, e DMV sono by-pass, commutatori e deviatori provvisti di dispositivo elettromeccanico per il comando a distanza.

Questi apparecchi permettono:

- la commutazione
- l'inversione della rete
- la commutazione sotto carico dei due circuiti
- il sezionamento di sicurezza

CARATTERISTICHE COSTRUTTIVE

Questi apparecchi presentano le seguenti caratteristiche costruttive principali:

- dimensioni compatte (nelle versioni CKS, CKF, DKF e DKS)
- scatola isolante in massa poliestere autoestinguente e antiraccia
- contatti in rame elettrolitico argentato
- dispositivo di comando manuale alloggiato nella scatola isolante in posizione centrale del comando (nelle versioni CKS, CKF, DKS e DKF)
- tenuta termica e dinamica elevate
- possibilità di lucchettaggio con tre lucchetti
- adatti per ambienti inquinati e climi tropicali secondo Norme IEC 60068-2 (serie)
- apparecchi quadripolari per l'interruzione omipolare delle fasi. il contatto neutro si chiude prima e si apre dopo le fasi
- nelle versioni motorizzate, in caso di mancanza della tensione ausiliaria, la possibilità di continuare la manovra con il dispositivo manuale

Norme di riferimento

i commutatori, i deviatori ed i by-pass sono costruiti in conformità alle seguenti Norme:

- EN 60947-3
- CEI EN 60947-3
- NF EN 60947-3
- NBN EN 60947-3
- BS EN 60947-3

GENERAL

CKS, CKF, CNQ, CNS, CNP, CNF, DKS, DKF, DNQ, DNS, DNP and DNF are change-over switches / deviators having manual operation and they can be 3-4-6-8 pole pattern. BPV and BPD are manually operated by-pass switches and they can be 3-4 pole pattern. BPM, BMD, CMF, CKM, CMV, DMF, DKM, and DMV are by pass, change-over and deviator switches all provided with an electromechanical device for the remote control.

These equipment realize:

- the change-over
- the network inversion
- the on-load change over of the two circuits
- the safety isolation

MANUFACTURING DETAILS

The above pattern has the following main manufacturing characteristics:

- Reduced dimensions (CKS, CKF, DKF and DKS series)
- Insulating case made with self-extinguishing and antitrack polyester compound
- Silvered electrolytic copper contacts
- Manual operating device fitted in the insulating case in central position (CKS, CKF, DKS and DKF series)
- High thermal and dynamic performances
- Padlocking facility up to 3 padlocks
- Suitable for polluted and tropical environment as per IEC 60068-2 (series) Standards
- 4 pole pattern suitable for the breaking of all phases; the neutral contact makes before and breaks after the phase contacts.
- In the motor driven application in case of supply voltage failure or lack, possibility to complete the operation by manual handle.

Reference Standards

change-over switches, deviators and by-pass are designed manufactured and tested in compliance with the following standards:

- EN 60947-3
- CEI EN 60947-3
- NF EN 60947-3
- NBN EN 60947-3
- BS EN 60947-3

Nota A: contatti in serie
4 interruzioni per fase

Note A: contacts in series
4 breaking for phase

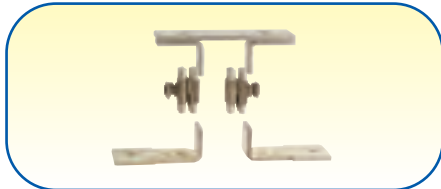

Nota D⁽¹⁾: contatto singolo
doppia interruzione (in serie)

Note D⁽¹⁾: single contact
double breaking for phase (in series)

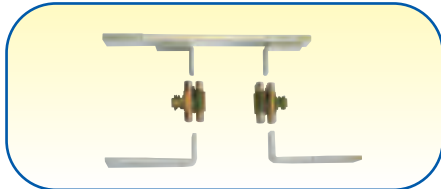

Nota B: contatti in parallelo.
doppia interruzione (in serie)

Note B: contacts in parallel
double breaking for phase (in series)

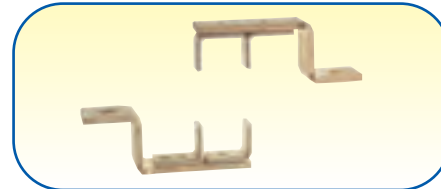

Nota D⁽²⁾: contatti in parallelo
doppia interruzione (in serie)

Note D⁽²⁾: contacts in parallel
double breaking for phase (in series)

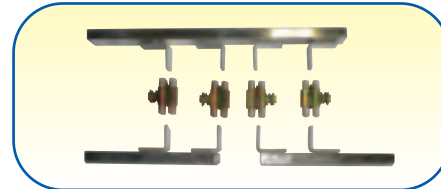

Nota C: contatti in serie con fusibili
4 interruzioni per fase

Note C: contacts in series with fuses
4 breaking for phase

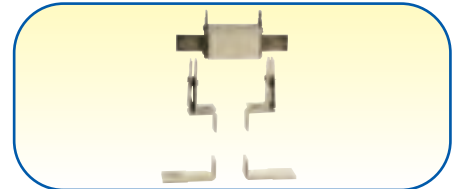

Nota E: contatti in parallelo con fusibile
doppia interruzione (in serie)

Note E: contacts in parallel with fuses
double breaking for phase (in series)

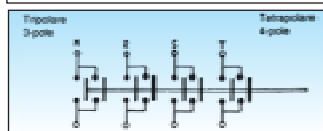
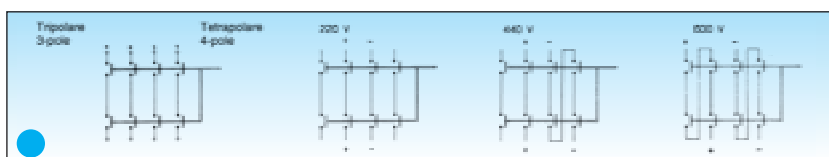
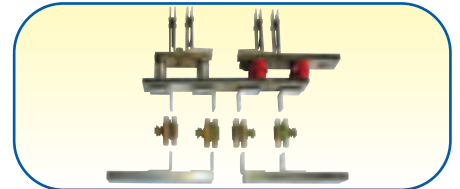

● Nota F: vedi tab. pag. 2 e 21 - Note F: see tables pages 2 and 21

● Nota G: vedi tab. pag. 25 - Note G: see table page 25

COMMUTATORE CON RIDUTTORE INTEGRALE
CON INCORPORATO CIRCUITO ELETTRICO
CHANGE-OVER SWITCH WITH REDUCTION GEAR
INCORPORATING ELECTRICAL WIRINGS

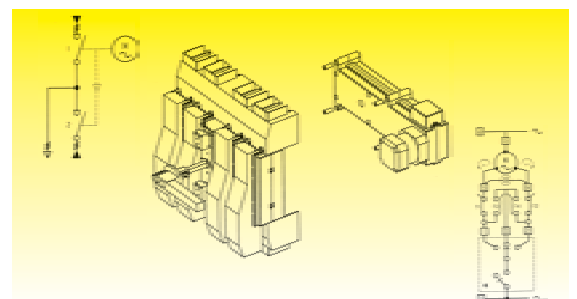

COMMUTATORI - CHANGE-OVER SWITCHES

Monoblocco CKS - One-case CKS	pag 3	vedi nota D - see note D
Caratteristiche elettriche - Electrical features	pag 2	
Verticali CNQ (fino a 400A) - Vertical CNQ (up to 400A)	pag 8	vedi nota D - see note D
Caratteristiche elettriche - Electrical features	pag 7	
Verticali CNP - Vertical CNP	pag 10	vedi nota B - see note B
Caratteristiche elettriche - Electrical features	pag 9	
Monoblocco CKF con fusibili - One-case CKF with fuses	pag 24-25	vedi nota E - see note E
Caratteristiche elettriche - Electrical features	pag 23	
Orizzontali CNS - Horizontal CNS	pag 29-30	vedi nota A - see note A
Caratteristiche elettriche - Electrical features	pag 28	
Orizzontali CNP - Horizontal CNP	pag 32-33	vedi nota B - see note B
Caratteristiche elettriche - Electrical features	pag 31	
Orizzontali CNP (da 2500A a 7000A) - Horizontal CNP (from 2500A to 7000A)	pag 11-12	vedi nota B - see note B
Caratteristiche elettriche - Electrical features	pag 9	
Orizzontali CNF con fusibili - Horizontal CNF with fuses	pag 35-36	vedi nota C - see note C
Caratteristiche elettriche - Electrical features	pag 34	

DEVIATORI - DEVIATORS

Monoblocco DKS - One-case DKS	pag 3	vedi nota D - see note D
Caratteristiche elettriche - Electrical features	pag 2	
Verticali DNQ (fino a 400A) - Vertical DNQ (up to 400A)	pag 8	vedi nota D - see note D
Caratteristiche elettriche - Electrical features	pag 7	
Verticali DNP - Vertical DNP	pag 8	vedi nota B - see note B
Caratteristiche elettriche - Electrical features	pag 7	
Monoblocco DKF con fusibili - One-case DKF with fuses	pag 24-25	vedi nota E - see note E
Caratteristiche elettriche - Electrical features	pag 23	
Orizzontali DNS - Horizontal DNS	pag 29-30	vedi nota A - see note A
Caratteristiche elettriche - Electrical features	pag 28	
Orizzontali DNP - Horizontal DNP	pag 32-33	vedi nota B - see note B
Caratteristiche elettriche - Electrical features	pag 31	
Orizzontali DNP (da 2500A a 6300A) - Horizontal DNP (from 2500A to 6300A)	pag 11-12	vedi nota B - see note B
Caratteristiche elettriche - Electrical features	pag 9	
Orizzontali DNF con fusibili - Horizontal DNF with fuses	pag 35-36	vedi nota C - see note C
Caratteristiche elettriche - Electrical features	pag 34	

BY-PASS

By-Pass Commutatori BPV - By-Pass change-over switches BPV	pag 18-19	vedi nota B - see note B
Caratteristiche elettriche - Electrical features	pag 9	
By-Pass Deviatori BPD - By-Pass deviators BPD	pag 18-19	vedi nota B - see note B
Caratteristiche elettriche - Electrical features	pag 9	

MOTORIZZATI - MOTOR DRIVEN

Commutatore monoblocco CKM - One-case change-over switch CKM	pag 4-5-6	vedi nota D - see note D
Caratteristiche elettriche - Electrical features	pag 2	
Commutatore CMV - Change-over switch CMV	pag 13-14	vedi nota B - see note B
Caratteristiche elettriche - Electrical features	pag 9	
Commutatore CMV (da 2500A a 7000A) - Change-over switch CMV (from 2500A to 7000A)	pag 15-16-17	vedi nota B - see note B
Caratteristiche elettriche - Electrical features	pag 9	
By-Pass commutatore BPM - By-Pass change-over switch BPM	pag 20-21-22	vedi nota B - see note B
Caratteristiche elettriche - Electrical features	pag 9	
Commutatore monoblocco CMF con fusibili - One-case change-over switch CMF with fuses	pag 24-25	vedi nota E - see note E
Caratteristiche elettriche - Electrical features	pag 23	
Deviatore monoblocco DKM - One-case deviator DKM	pag 4-5-6	vedi nota D - see note D
Caratteristiche elettriche - Electrical features	pag 2	
Deviatore DMV - Deviator DMV	pag 13-14	vedi nota B - see note B
Caratteristiche elettriche - Electrical features	pag 9	
Deviatore DMV (da 2500A a 7000A) - Deviator DMV (from 2500A to 7000A)	pag 15-16-17	vedi nota B - see note B
Caratteristiche elettriche - Electrical features	pag 9	
By-pass deviatore BMD - By-pass deviator BMD	pag 20-21-22	vedi nota B - see note B
Caratteristiche elettriche - Electrical features	pag 9	
Deviatore monoblocco DMF con fusibili - One-case deviator DMF with fuses	pag 24-25	vedi nota E - see note E
Caratteristiche elettriche - Electrical features	pag 23	

ACCESSORI - ACCESSORIES

Maniglie Rinviatè - Handles for door	pag 38-39
Maniglie Dirette - Direct Handles	pag 40-41
Accessori e dime di foratura per maniglie - Accessories and drilling template for handles	pag 42
Accessori - Accessories	pag 43-44-45

caratteristiche tecniche - technical characteristics

CKS / DKS / CKM / DKM (da pagina 3 a pagina 6 - from page 3 to page 6)

CORRENTE NOMINALE A T.A. MAX 40°C RATED THERMAL CURRENT AT 40°C MAX A.T.	A	125	160	200	250	400	630	800	1000	1250	1600
NUMERO DEI POLI - NUMBER OF POLES	----	3-4-6-8	3-4-6-8	3-4-6-8	3-4-6-8	3-4-6-8	3-4-6-8	3-4-6-8	3-4-6-8	3-4-6-8	3-4-6-8
TENSIONE D'ISOLAMENTO - RATED VOLTAGE OF ISOLATION c.c./d.c.	V	1000 600	1000 600	1000 600	1000 600	1000 600	1000 600	1000 600	1000 600	1000 600	1000 600
TENSIONE DI TENUTA AD IMPULSO - IMPULSE WITHSTAND VOLTAGE	KV	8	8	8	8	8	8	12	12	12	12
CORRENTE D'IMPIEGO - OPERATIONAL CURRENT AC21 - AC22	A	125	160	200	250	400	630	800	1000	1250	1600
CORRENTE D'IMPIEGO - OPERATIONAL CURRENT AC23	A	125 63	160 80	200 100	250 125	400 160	630 200	800 250	1000 315	1250 400	1600 500
CORRENTE D'IMPIEGO - OPERATIONAL CURRENT DC21	A	125	160	200	250	400	630	800	1000	1250	1600
note (F) page 0											
CORRENTE D'IMPIEGO - OPERATIONAL CURRENT DC22	A	125	160	200	250	400	630	800	1000	1250	1600
note (F) page 0											
CORRENTE D'IMPIEGO - OPERATIONAL CURRENT DC23	A	100	125	150	200	250	400	630	800	1000	1000
note (F) page 0											
POTENZA REATTIVA - REACTIVE POWER note(1)	KVAr	55	70	80	100	150	250	300	375	450	550
CORRENTE DI BREVE DURATA - RATED SHORT-TIME WITHSTAND CURRENT	I _{ctw}	8	10	10	12,5	15	16	30	31,5	35	35
POTERE DI CHIUSURA IN C.T.O - RATED SHORT-CIRCUIT MAKING CAPACITY	I _{cm}	KA	KA	KA	KA	KA	KA	KA	KA	KA	KA
DURATA MECCANICA - MECHANICAL ENDURANCE	n°	8000	8000	8000	8000	5000	5000	3000	3000	3000	3000
VITA ELETTRICA - ELECTRICAL LIFE	n°	1000	1000	1000	1000	1000	1000	500	500	500	500
TEMPI DI COMMUTAZIONE I-O-II o II-O-I - CHANGE-OVER TIME I-O-II o II-O-I	(sec)	4	4	4	4	4	4	5	5	5	5
POTENZA DISSIPATA PER POLO - POWER LOSSES FOR POLE	W	1,6	2,6	4	4,7	11	25	22,5	34	53	65
PESO - WEIGHT CKS DKS 3 pole	Kg	4	4	4	7	7	7,5	11	15	19	19
PESO - WEIGHT CKS DKS 4 pole	Kg	4,5	4,5	4,5	7,8	7,8	8,3	17	18,5	20,5	20,5
PESO - WEIGHT CKS DKS 6 pole	Kg	8,1	8,1	8,1	14,2	14,2	15,2	22,4	30,4	38,4	38,4
PESO - WEIGHT CKS DKS 8 pole	Kg	9,1	9,1	9,1	15,8	15,8	16,8	34,4	37,4	41,4	41,4
PESO - WEIGHT CKM DKM 3 pole 24V dc note(2) and 220V-240V ac note(3)	Kg	5,8 (2) 6,3 (2)	5,8 (2) 6,3 (2)	5,8 (2) 6,3 (2)	9,3 (2) 10,1 (2)	9,3 (2) 10,1 (2)	9,8 (2) 10,6 (2)	11 (2) 11,8 (2)	14,3 (2) 15,5 (2)	18,3 (2) 19,5 (2)	22,3 (2) 23,5 (2)
PESO - WEIGHT CKM DKM 4 pole 24V dc note(2) and 220V-240V ac note(3)	Kg	6,3 (2) 9,9 (2)	6,3 (2) 9,9 (2)	6,3 (2) 9,9 (2)	10,1 (2) 11,3 (2)	10,1 (2) 11,3 (2)	10,6 (2) 11,8 (2)	20,3 (2) 21,5 (2)	21,8 (2) 23 (2)	23,8 (2) 25 (2)	23,8 (2) 25 (2)
PESO - WEIGHT CKM DKM 6 pole 24V dc note(2) and 220V-240V ac note(3)	Kg	9,9 (2) 10,9 (2)	9,9 (2) 10,9 (2)	9,9 (2) 10,9 (2)	16,5 (2) 17,7 (2)	16,5 (2) 17,7 (2)	17,5 (2) 18,7 (2)	25,7 (2) 26,9 (2)	33,7 (2) 34,9 (2)	41,7 (2) 42,9 (2)	41,7 (2) 42,9 (2)
PESO - WEIGHT CKM DKM 8 pole 24V dc note(2) and 220V-240V ac note(3)	Kg	10,9 (2) 11,1 (2)	10,9 (2) 11,1 (2)	10,9 (2) 11,1 (2)	18,1 (2) 19,3 (2)	18,1 (2) 19,3 (2)	19,1 (2) 20,3 (2)	37,7 (2) 38,9 (2)	40,7 (2) 41,9 (2)	44,7 (2) 45,9 (2)	44,7 (2) 45,9 (2)

note (1) a causa delle armoniche e delle tolleranze dei condensatori, i valori nominali devono essere ridotti del 33% - due to harmonics and tolerance of the capacitors, the rated values have been reduced by 33%

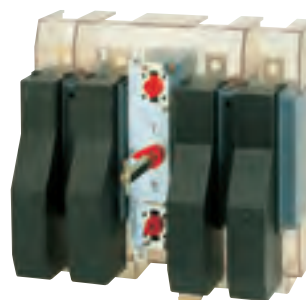
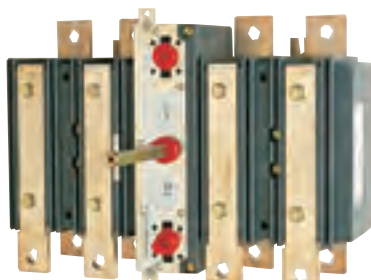

codici per ordini - ordering codes

CKS	125A	160A	200A	250A	400A	630A	800A	1000A	1250A	1600A
3 pole	ECKS01253000A	ECKS01603000A	ECKS02003000A	ECKS02503000A	ECKS04003000A	ECKS06303000A	ECKS08003000A	ECKS10003000A	ECKS12503000A	ECKS16003000A
4 pole	ECKS01254002A	ECKS01604002A	ECKS02004002A	ECKS02504002A	ECKS04004002A	ECKS06304002A	ECKS08004002A	ECKS10004002A	ECKS12504002A	ECKS16003000A
6 pole	ECKS01256000A	ECKS01606000A	ECKS02006000A	ECKS02506000A	ECKS04006000A	ECKS06306000A	ECKS08006000A	ECKS10006000A	ECKS12506000A	ECKS16003000A
8 pole	ECKS01258002A	ECKS01608002A	ECKS02008002A	ECKS02508002A	ECKS04008002A	ECKS06308002A	ECKS08008002A	ECKS10008002A	ECKS12508002A	ECKS16003000A

Per ordinare i Deviatori (II-I) sostituire la seconda lettera C del codice con la lettera D
 Esempio: ECKS01253000A diventa EDKS01253000A
 To order Deviators (II-I) replace the second letter C of code with letter D
 Example: ECKS01253000A becomes EDKS01253000A
 nota: per gli ordini in Italia sostituire con la J la E iniziale del codice prodotto

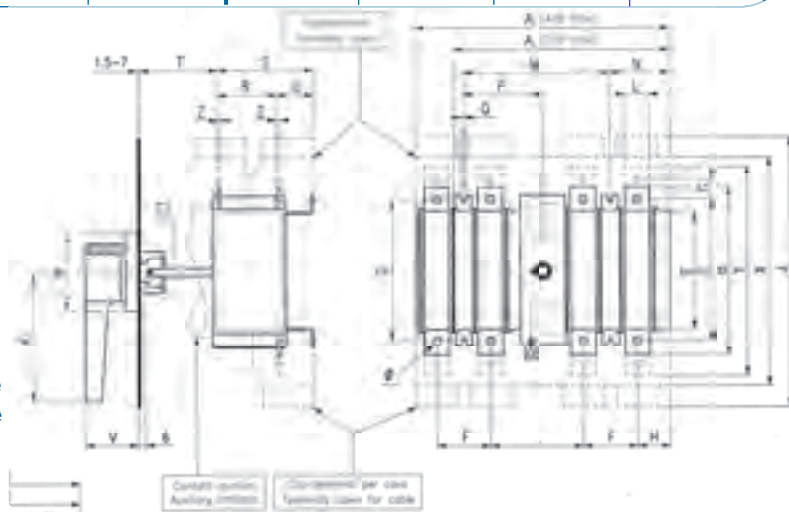

CKS 125A:1250A 3-4 pole
 DKS 125A:1250A 3-4 pole

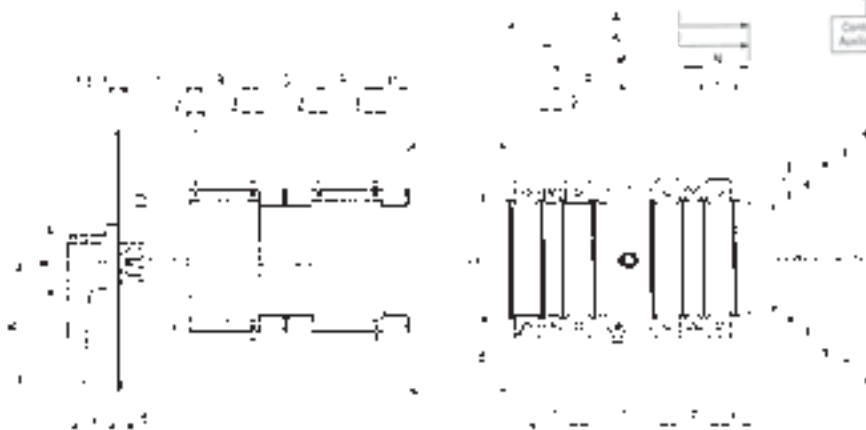

CKS 125A:1250A 6-8 pole
 DKS 125A:1250A 6-8 pole

	A	A	B	C	D	E	F	G	H	I	J	K	L	M	N	P	Q	R	S	S	T	U	V	W	X	Y	Z	□	∅
	3-6 pole	4-8 pole																	3-4 pole	6-8 pole									
CKS - DKS 125A																													
CKS - DKS 160A	202	230	174	154	150	124	44	...	32,5	92	254	125	20	136	51,5	71,5	6,5	64	108	84	90	44	59	94	214	...	3	10	8,5
CKS - DKS 200A																													
CKS - DKS 250A													25						77	121	74							4	
CKS - DKS 400A	260	307	218	193	168	142	65	...	39,5	112,3	320	125	30	177	72	96	6,5	78	122		115	43	59	94	274	...	5	10	10,5
CKS - DKS 630A													35						79	123	73						6		
CKS - DKS 800A																			86	137	88						8		
CKS - DKS 1000A																													
CKS - DKS 1250A	320,5	392	292	252	230	208	87	...	49	134		166	40	221	89	107	6,5	88	139	86	107	48	59	94	384	...	10	12	13
CKS - DKS 1600A																										352			

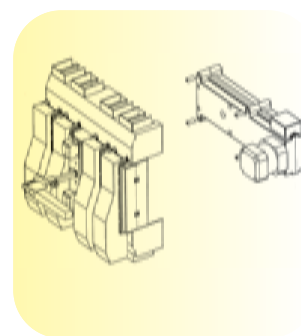

codici per ordini - ordering codes

da 220V a 240V corrente alternata 50/60 Hz
 from 220V to 240V alternating current 50/60 Hz

CKM	125A	160A	200A	250A	400A	630A	800A	1000A	1250A	1600A
3 pole	ECKM01253000A	ECKM01603000A	ECKM02003000A	ECKM02503000A	ECKM04003000A	ECKM06303000A	ECKM08003000A	ECKM10003000A	ECKM12503000A	ECKM16003000A
4 pole	ECKM01254002A	ECKM01604002A	ECKM02004002A	ECKM02504002A	ECKM04004002A	ECKM06304002A	ECKM08004002A	ECKM10004002A	ECKM12504002A	ECKM16004002A
6 pole	ECKM01256000A	ECKM01606000A	ECKM02006000A	ECKM02506000A	ECKM04006000A	ECKM06306000A	ECKM08006000A	ECKM10006000A	ECKM12506000A	ECKM16006000A
8 pole	ECKM01258002A	ECKM01608002A	ECKM02008002A	ECKM02508002A	ECKM04008002A	ECKM06308002A	ECKM08008002A	ECKM10008002A	ECKM12508002A	ECKM16008002A

Per ordinare i Deviatori (II-I) sostituire la seconda lettera **C** del codice con la lettera **D**. Esempio: ECKM01253000A diventa EDKM01253000A
 To order Deviators (II-I) replace the second letter **C** of code with letter **D**. Example: ECKM01253000A becomes EDKM01253000A
 Per ordinare il 24V a corrente continua sostituire la lettera finale **A** del codice del prodotto (CKM o DKM 220V-240V) con la lettera **H**
 Esempio ECKM01253000A diventa ECKM01253000H

To order 24V direct current replace the letter **A** of CKM or DKM 220V-240V ordering code with letter **H**
 Example: ECKM01253000A becomes ECKM01253000H

Per altre esecuzioni contattare il nostro ufficio tecnico
 Please contact our technical department for other executions

nota: per gli ordini in Italia sostituire con la J la E iniziale nel codice prodotto



completi di
 scheda elettronica di controllo
 complete with
 electronic control card

codici per ordini - ordering codes

da 220V a 240V corrente alternata 50/60 Hz
 from 220V to 240V alternating current 50/60 Hz

CKM _s	125A	160A	200A	250A	400A	630A	800A	1000A	1250A	1600A
3 pole	ECKM01253000S	ECKM01603000S	ECKM02003000S	ECKM02503000S	ECKM04003000S	ECKM06303000S	ECKM08003000S	ECKM10003000S	ECKM12503000S	ECKM16003000S
4 pole	ECKM01254002S	ECKM01604002S	ECKM02004002S	ECKM02504002S	ECKM04004002S	ECKM06304002S	ECKM08004002S	ECKM10004002S	ECKM12504002S	ECKM16004002S
6 pole	ECKM01256000S	ECKM01606000S	ECKM02006000S	ECKM02506000S	ECKM04006000S	ECKM06306000S	ECKM08006000S	ECKM10006000S	ECKM12506000S	ECKM16006000S
8 pole	ECKM01258002S	ECKM01608002S	ECKM02008002S	ECKM02508002S	ECKM04008002S	ECKM06308002S	ECKM08008002S	ECKM10008002S	ECKM12508002S	ECKM16008002S

Per ordinare i Deviatori (II-I) sostituire la seconda lettera **C** del codice con la lettera **D**. Esempio: ECKM01253000S diventa EDKM01253000S
 To order Deviators (II-I) replace the second letter **C** of code with letter **D**. Example: ECKM01253000S becomes EDKM01253000S
 Per ordinare il 24V a corrente continua sostituire la lettera finale **S** del codice del prodotto (CKM o DKM 220V-240V) con la lettera **T**
 Esempio ECKM01253000S diventa ECKM01253000T

To order 24V direct current replace the letter **S** of CKM or DKM 220V-240V ordering code with letter **T**
 Example: ECKM01253000S becomes ECKM01253000T

Per altre esecuzioni contattare il nostro ufficio tecnico
 Please contact our technical department for other executions

nota: per gli ordini in Italia sostituire con la J la E iniziale nel codice prodotto

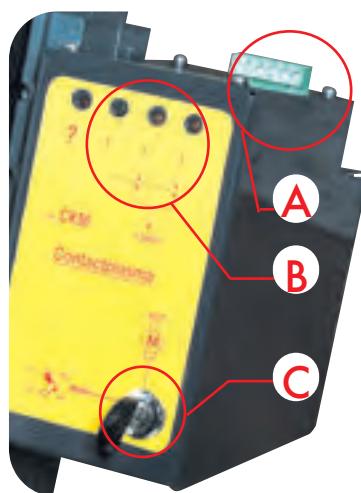

SCHEDA ELETTRONICA - ELECTRONIC CARD

CARATTERISTICHE E VANTAGGI	CHARACTERISTICS AND ADVANTAGES	ACCESSORI STANDARD	STANDARD ACCESSORIES
i relé e il cablaggi non sono più necessari	relays and relevant wiring are not necessary	n° 3 LED di segnalazione posizioni (I-0-II)	n° 3 position signalling (I-0-II) LEDs
protezione contro le anomalie	protection against incorrect operations	n° 1 LED di segnalazione delle anomalie	n° 1 abnormal condition signalling LEDs (?)
impossibilità di effettuare manovre elettriche in condizioni anomale	the motor driven operations are prevented during abnormal conditions	n° 1 selettore con chiave manuale-elettrico	n° 1 manual-automatic selector key
segnalazione delle anomalie	abnormal conditions signalling through LED	n° 2 morsetti per segnalazione a distanza	n° 2 available terminals for remote signalling
selettore con chiave manuale-elettrico	the manual - automatic selector key is already included in the supply		
il cliente finale deve solo cablare la morsettiera	the final costumer has only to wire the terminal block		

A	B	C
Morsettiera Terminal Block	Led di segnalazione signalling LEDs	Selettore con chiave comando manuale - elettrico manual-automatic key selector

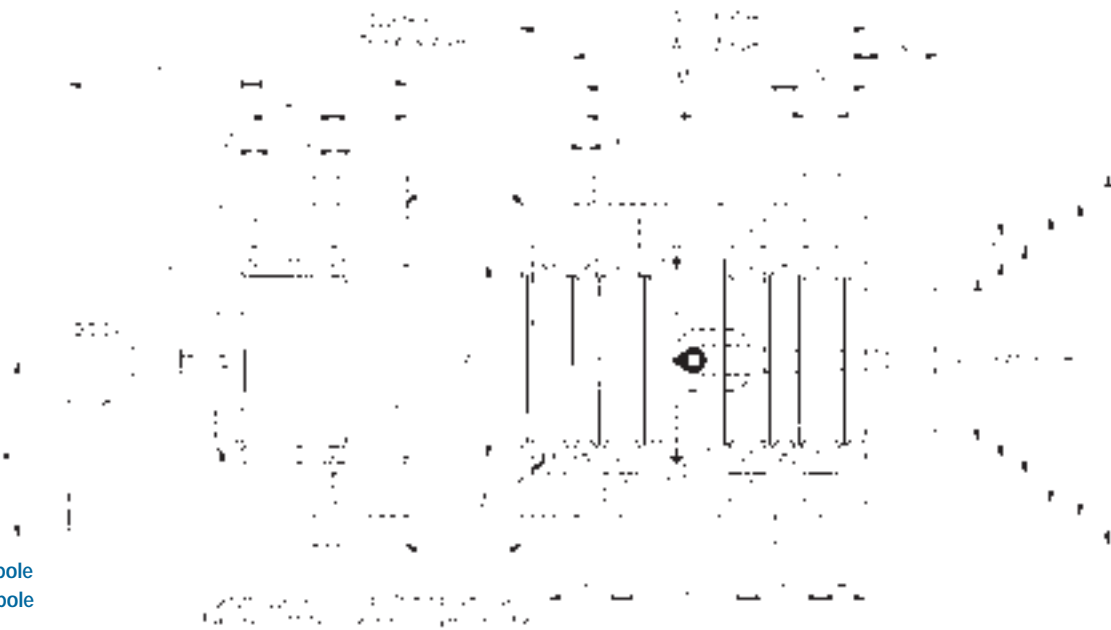

CKM 125A:1250A 3-4 pole
 DKM 125A:1250A 3-4 pole

	A	A	B	C	D	E	F	G	H	I	J	K	L	M	N	P	Q	R	S	T	U	X	Y	Z	□	∅	Ω	
	3 pole	4 pole																										
CKM - DKM 125A																												
CKM - DKM 160A	196,5	230	174	154	150	123,5	44	--	32,5	92	--	125	20	136	51,5	71,5	6,5	64	149	134	85	214	--	3	10	8,5	73	
CKM - DKM 200A																												
CKM - DKM 250A													25					78	158	163				4				
CKM - DKM 400A	260	307	220	190	168	142	65	--	39,5	112	325,5	125	30	177	72	96	6,5	79	159	162	80	279	--	5	10	10,5	76,5	
CKM - DKM 630A													35					80	160	161				6				
CKM - DKM 800A																		82	177	146,5				8				
CKM - DKM 1000A	320	392	292	252	230	208	87	--	49	134	435	166	40	221	89	112	6,5	84	179	144,5	95	384	--	10	12	13	82	
CKM - DKM 1250A																								352	10			
CKM - DKM 1600A																												

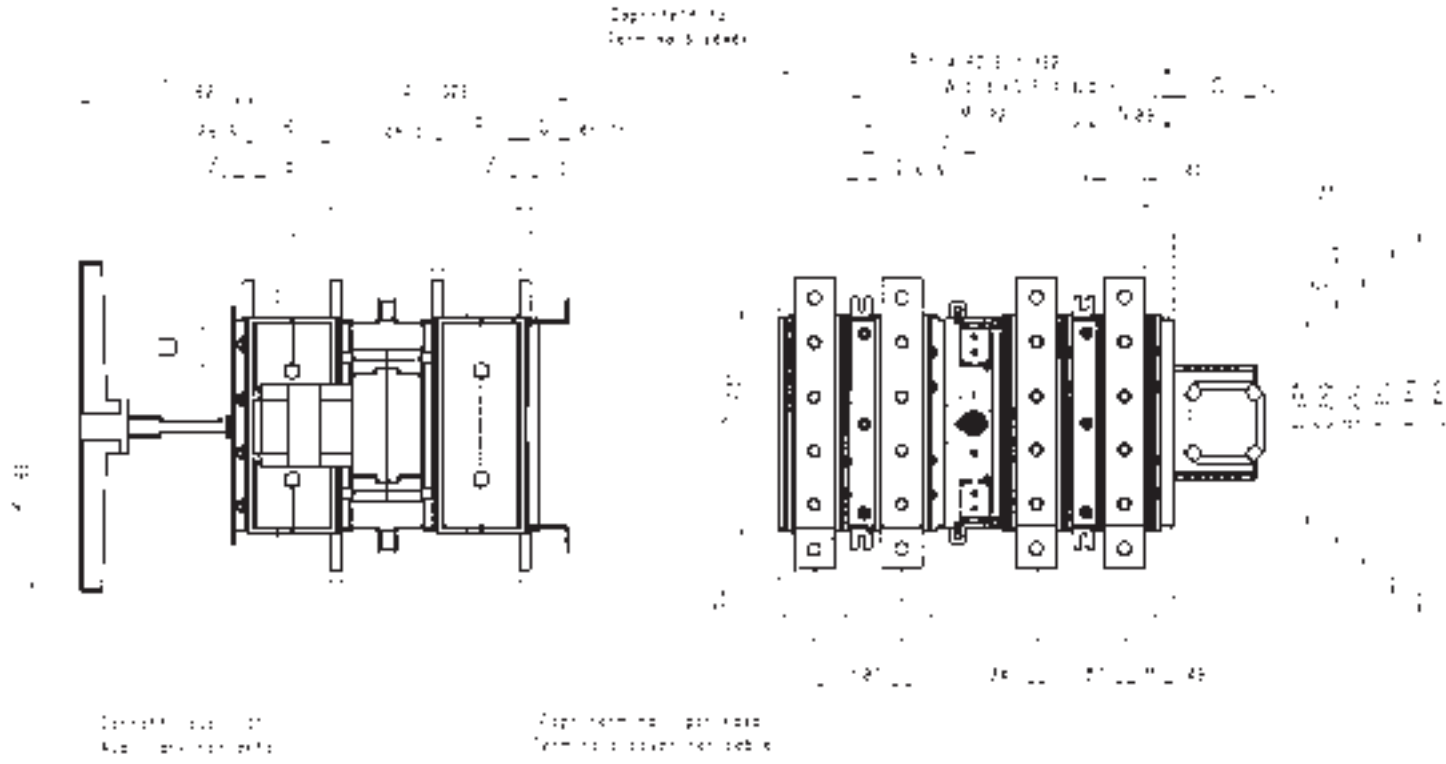

CKM 125A:1250A 6-8 pole
 DKM 125A:1250A 6-8 pole

	A	A	B	C	D	E	F	G	H	I	J	K	L	M	N	P	Q	R	S	T	U	X	Y	Z	□	∅	Ω
	6 pole	8 pole																									
CKM - DKM 125A																											
CKM - DKM 160A	196,5	230	174	154	150	123,5	44	—	32,5	92	—	125	20	136	51,5	71,5	6,5	64	268	140	45	214	—	3	10	8,5	85
CKM - DKM 200A																											
CKM - DKM 250A													25					78	282,5	160				4			
CKM - DKM 400A	260	307	220	190	168	142	65	—	39,5	112	325,5	125	30	177	72	96	6,5	79	283,5	159	44	274	—	5	10	10,5	76,5
CKM - DKM 630A													35					80	284,5	158				6			
CKM - DKM 800A																		82	320	160				8			
CKM - DKM 1000A	320	392	292	252	230	208	87	—	49	134	435	166	40	221	89	112	6,5	84	322	158	49	384	—	10	12	13	82
CKM - DKM 1250A								30															352				

caratteristiche tecniche - technical characteristics

CNQ/ DNQ (da pagina 22 a pagina 24 - from page 22 to page 24)

CORRENTE NOMINALE A T.A. MAX 40C° RATED THERMAL CURRENT AT 40°C MAX A. I.	I _{th}	in aria libera free air	A	125	160	200	250	315	400
		in cassetta box	A	125	150	160	250	300	340
NUMERO DEI POLI - NUMBER OF POLES		----	----	3-4-6-8	3-4-6-8	3-4-6-8	3-4-6-8	3-4-6-8	3-4-6-8
TENSIONE D'ISOLAMENTO - RATED VOLTAGE OF ISOLATION	U _i	c.a./a.c. c.c./d.c.	V	1000 600	1000 600	1000 600	1000 600	1000 600	1000 600
TENSIONE DI TENUTA AD IMPULSO - IMPULSE WITHSTAND VOLTAGE		----	KV	8	8	8	8	8	8
CORRENTE D'IMPIEGO - OPERATIONAL CURRENT	AC23A	415 V		125/55	160/75	200/105	250/132	315/155	400/200
		500 V	A/KW	125/75	160/100	200/125	250/160	315/200	400/280
		690 V		125/90	160/140	200/175	250/220	315/275	400/375
CORRENTE D'IMPIEGO - OPERATIONAL CURRENT	AC22A	1000 V	A	125	160	200	250	315	400
CORRENTE D'IMPIEGO - OPERATIONAL CURRENT	DC23A	220 V		125	160	200	250	315	400
note (F)		440 V	A	125	160	200	250	315	400
		600 V		125	160	200	250	315	400
POTENZA REATTIVA - REACTIVE POWER	note (1)	380 V	KVAr	60	75	100	125	150	250
CORRENTE DI BREVE DURATA RATED SHORT-TIME WITHSTAND CURRENT	I _{cw}	1 sec	KA r.m.s.	8	10	10	12,5	15	18
POTERE DI CHIUSURA IN C.T.O C.T.O RATED SHORT-CIRCUIT MAKING CAPACITY	I _{cw}	690 V	KA peak	20	25	25	31	37	44
DURATA MECCANICA - MECHANICAL ENDURANCE		operazioni - operations	n°	8000	8000	8000	8000	8000	5000
VITA ELETTRICA - ELECTRICAL LIFE		operazioni - operations	n°	1000	1000	1000	1000	1000	1000
POTENZA DISSIPATA PER POLO - POWER LOSSES FOR POLE		----	W	3,1	5,1	8	8,2	13	20
PESO - WEIGHT	CNS 3 pole - orizzontale - horizontal	----	Kg	6	6	6	10,1	10,5	10,5
	CNS 4 pole - orizzontale - horizontal	----	Kg	6,8	6,8	6,8	11,3	11,9	11,9
	CNQ 3 pole - verticale - vertical	----	Kg	5,9	5,9	5,9	9,9	10,3	10,3
	CNQ 4 pole - verticale - vertical	----	Kg	6,7	6,7	6,7	11,1	11,7	11,7
	DNS 3 pole - orizzontale - horizontal deviator	----	Kg	5,5	5,5	5,5	9,6	10	10
	DNS 4 pole - orizzontale - horizontal deviator	----	Kg	6,3	6,3	6,3	10,8	11,4	11,4
	DNQ 3 pole - verticale - vertical deviator	----	Kg	5,4	5,4	5,4	9,4	9,8	9,8
	DNQ 4 pole - verticale - vertical deviator	----	Kg	6,2	6,2	6,2	10,6	11,2	11,2

note (1) a causa delle armoniche e delle tolleranze dei condensatori, i valori nominali devono essere ridotti del 33%
 due to harmonics and tolerance of the capacitors, the rated values have been reduced by 33%

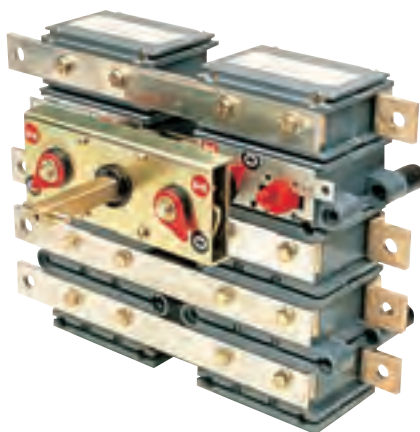

codici per ordini - ordering codes

CNQ	125A	160A	200A	250A	400A
3 pole	ECNQ01253000V	ECNQ01603000V	ECNQ02003000V	ECNQ02503000V	ECNQ04003000V
4 pole	ECNQ01254002V	ECNQ01604002V	ECNQ02004002V	ECNQ02504002V	ECNQ04004002V

Per ordinare i Deviatori (II-I) sostituire la seconda lettera C del codice con la lettera D. Esempio: ECNQ01253000V diventa EDNQ01253000V
 To order Deviators (II-I) replace the second letter C of code with letter D. Example: ECNQ01253000V becomes EDNQ01253000V

nota: per gli ordini in Italia sostituire con la J la E iniziale nel codice prodotto

CNQ 125A:400A 3-4 pole
 DNO 125A:400A 3-4 pole

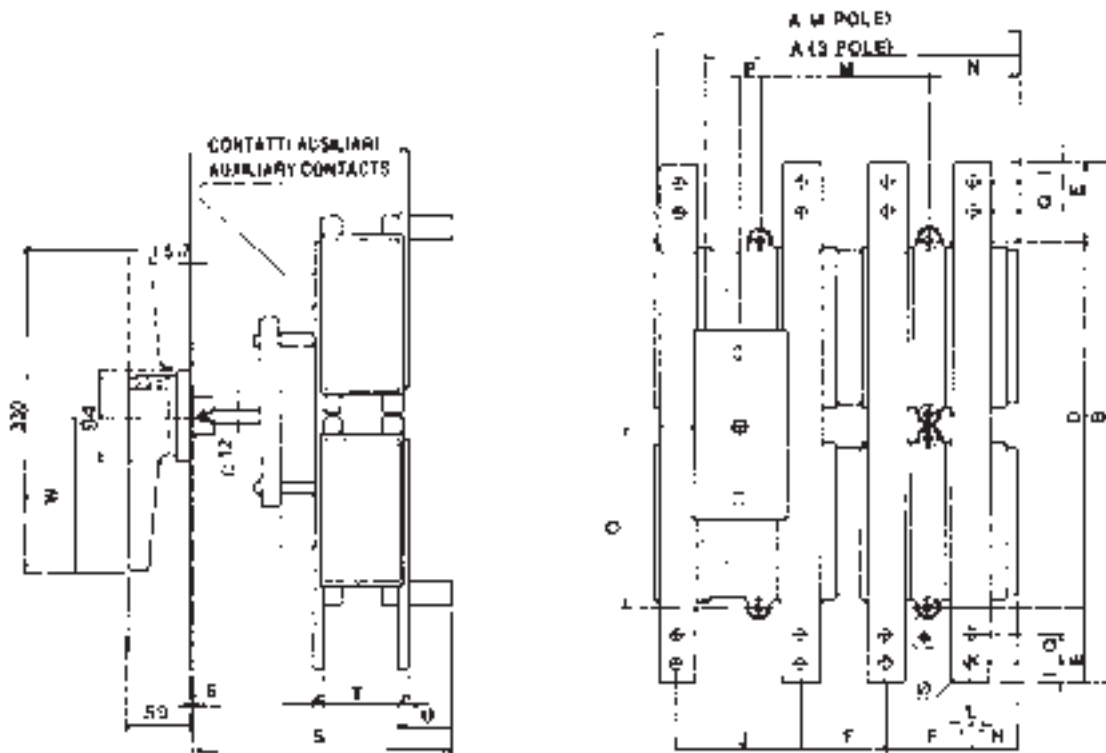

	A	A	B	D	E	F	H	I	J	L	M	N	O	P	Q	S	T	U	W	Z	Ø	*
	3 pole	4 pole																				
CNQ-DNO 125A																						
CNQ-DNO 160A	181	222	270	244	13	44	32	8	82	20	98	51	122	6	--	220	57	29	125	3	8,5	5,5
CNQ-DNO 200A																						
CNQ-DNO 250A	256	306	306	264	21	65	42	12	109	30	137	72	132	12	--	248	67	36	125	4	10,5	6,5
CNQ-DNO 400A																						

caratteristiche tecniche-technical characteristics

CNP / DNP / CMV / DMV / DMV / BPD / BMD (da pagina 8 a pagina 20 - from page 8 to page 20)

small cases medium cases

	A	125	160	200	250	250	315	400	630	800	1000	1250	1600	1800	2000	2500	3150	4000	5000	6300	7000	
CORRENTE NOMINALE A TA. MAX 40C° RATED THERMAL CURRENT AT 40°C MAX A.T.	in aria libera free air	125	150	160	200	250	250	315	400	630	800	1000	1250	1600	1800	2000	2500	3150	4000	5000	6300	7000
	in cassetta box	125	150	160	200	250	300	350	400	630	720	910	1250	1600	1600	1800	2200	2500	3400	4200	5500	6000
NUMERO DEI POLI - NUMBER OF POLES	----	3-4-6-8	3-4-6-8	3-4-6-8	3-4-6-8	3-4-6-8	3-4-6-8	3-4-6-8	3-4-6-8	3-4-6-8	3-4-6-8	3-4-6-8	3-4-6-8	3-4-6-8	3-4-6-8	3-4-6-8	3-4-6-8	3-4-6-8	3-4-6-8	3-4-6-8	3-4-6-8	3-4-6-8
TENSIONE D'ISOLAMENTO - RATED VOLTAGE OF ISOLATION	U _i	1000	1000	1000	1000	1000	1000	1000	1000	1000	1000	1000	1000	1000	1000	1000	1000	1000	1000	1000	1000	1000
TENSIONE DI TENUTA AD IMPULSO - IMPULSE WITHSTAND VOLTAGE		600	600	600	600	600	600	600	600	600	600	600	600	600	600	600	600	600	600	600	600	600
CORRENTE D'IMPIEGO - OPERATIONAL CURRENT AC21	I _e	125	160	200	250	250	315	400	630	800	1000	1250	1600	1800	2000	2500	3150	4000	5000	6300	7000	
CORRENTE D'IMPIEGO - OPERATIONAL CURRENT AC22	I _e	125	160	200	250	250	315	400	630	800	1000	1250	1600	1800	2000	2500	3150	4000	5000	6300	7000	
CORRENTE D'IMPIEGO - OPERATIONAL CURRENT AC23	I _e	125	160	200	250	250	315	400	630	800	1000	1250	1600	1800	2000	2500	3150	4000	5000	6300	7000	
POTENZA REATTIVA - REACTIVE POWER note (1)	KVAR	60	75	100	125	125	150	200	280	300	320	400	500	55	60	80	85	100	120	120	120	120
CORRENTE DI BREVE DURATA RATED SHORT-TIME WITHSTAND CURRENT	I _{cw}	8	10	10	12,5	19	15	21	32	36	40	50	55	55	60	80	85	100	120	120	120	120
POTERE DI CHIUSURA IN C.TO C.TO RATED SHORT-CIRCUIT MAKING CAPACITY	I _{cm}	20	25	25	31	40	37	45	67	76	84	105	121	121	132	176	187	187	200	200	200	200
DURATA MECCANICA - MECHANICAL ENDURANCE		8000	8000	8000	8000	8000	8000	8000	5000	5000	3000	3000	3000	3000	3000	3000	2000	2000	2000	2000	2000	2000
VITA ELETTRICA - ELECTRICAL LIFE		1000	1000	1000	1000	1000	1000	1000	1000	1000	500	500	500	500	500	500	500	500	500	500	500	500
TEMPI DI COMMUTAZIONE I-O-II O II-O-I CHANGE-OVER TIME I-O-II O II-O-I	(sec)	12	12	12	12	12	12	12	12	12	12	12	12	12	12	12	12	12	12	12	12	12
POTENZA DISSIPATA PER POLO - POWER LOSSES FOR POLE		3,1	5,1	8	3,3	8,2	8,8	8,8	8,8	23	25	34	40	63	65	80	124	142	150	230	230	230
PESO - WEIGHT CNP 3 pole vertical	W	-	-	-	6,7	-	7,1	7,1	7,1	11,1	13,3	21,7	26,2	29,2	34,4	34,4	-	-	-	-	-	-
PESO - WEIGHT CNP 4 pole vertical	Kg	-	-	-	7,5	-	8,8	8,8	8,8	12,9	15,3	26	30,2	34,2	42,8	42,8	-	-	-	-	-	-
PESO - WEIGHT CNP 3 pole horizontal	Kg	-	-	-	6,8	-	7,1	7,1	7,1	11,1	13,5	23	26,7	28,7	36,7	36,7	93,5	94,7	169	169	169	169
PESO - WEIGHT CNP 4 pole horizontal	Kg	-	-	-	7,6	-	8,8	8,8	8,8	12,9	15,5	25	30,7	35,7	45,7	45,7	111,5	112,7	224	224	224	224
PESO - WEIGHT DNP 3 pole vertical	Kg	-	-	-	6,2	-	6,6	6,6	6,6	10,6	12,8	21	25,5	28,5	33,7	33,7	-	-	-	-	-	-
PESO - WEIGHT DNP 4 pole vertical	Kg	-	-	-	7	-	8,3	8,3	8,3	12,4	14,8	25,3	29,5	33,5	42,1	42,1	-	-	-	-	-	-
PESO - WEIGHT DNP 3 pole horizontal	Kg	-	-	-	6,4	-	6,6	6,6	6,6	10,6	13	22,3	26	28	36	36	-	-	-	-	-	-
PESO - WEIGHT DNP 4 pole horizontal	Kg	-	-	-	7,2	-	8,3	8,3	8,3	12,4	15	24,3	30	35	45	45	-	-	-	-	-	-
PESO - WEIGHT CMV 3 pole motor driver c/o switches	Kg	14,2	14,2	15,6	15,6	19,2	19,6	19,6	20,4	22,6	34,2	38,7	41,7	46,4	46,4	110,5	110,5	111,7	-	-	-	-
PESO - WEIGHT CMV 4 pole motor driver c/o switches	Kg	15	15	16,5	16,5	20,6	21	21	22	24,6	38,5	42,7	46,7	54	54	128,5	128,5	129,7	-	-	-	-
PESO - WEIGHT DMV 3 pole motor driver deviator c/o switches	Kg	13,2	13,2	15	15	18,8	19,2	19,2	20	22	33,2	37,7	40	43,4	43,4	120	120	122	-	-	-	-
PESO - WEIGHT DMV 4 pole motor driver deviator c/o switches	Kg	14	14	16	16	20	20,4	20,4	22	24	37,5	41,5	45	51	51	125	125	130	-	-	-	-
PESO - WEIGHT BPV 3 pole by-pass	Kg	5,9	5,9	5,9	9,7	-	10,3	10,3	16,3	19,6	28	38,7	42,7	51,9	51,9	-	-	-	-	-	-	-
PESO - WEIGHT BPV 4 pole by-pass	Kg	6,7	6,7	6,7	10,5	-	12,8	12,8	18,9	22,6	33,3	44,7	51,2	64,8	64,8	-	-	-	-	-	-	-
PESO - WEIGHT BPD 3 pole by-pass deviator	Kg	5,4	5,4	5,4	9,2	-	9,8	9,8	15,8	19,1	27,5	38	42	51,2	51,2	-	-	-	-	-	-	-
PESO - WEIGHT BPD 4 pole by-pass deviator	Kg	6,2	6,2	6,2	10	-	12,3	12,3	18,4	22,1	34,8	44	50,5	64,1	64,1	-	-	-	-	-	-	-
PESO - WEIGHT BPM 3 pole motor by-pass	Kg	14,2	14,2	14,2	18,6	-	22,8	22,8	25,6	28,9	40,5	51,2	55,2	63,9	63,9	-	-	-	-	-	-	-
PESO - WEIGHT BPM 4 pole motor by-pass	Kg	15	15	15	20,3	-	24,8	24,8	28	31,9	45,8	57,2	63,7	76	76	-	-	-	-	-	-	-
PESO - WEIGHT BMD 3 pole motor by-pass deviator	Kg	13,2	13,2	13,2	18	-	22,4	22,4	25,2	28,3	39,5	50,2	53,5	60,9	60,9	-	-	-	-	-	-	-
PESO - WEIGHT BMD 4 pole motor by-pass deviator	Kg	14	14	14	19,8	-	24,2	24,2	28	31,3	44,8	56	62	73	73	-	-	-	-	-	-	-

note (1) a causa delle armoniche e delle tolleranze dei condensatori, i valori nominali devono essere ridotti del 33% - due to harmonics and tolerance of the capacitors, the rated values have been reduced by 33%

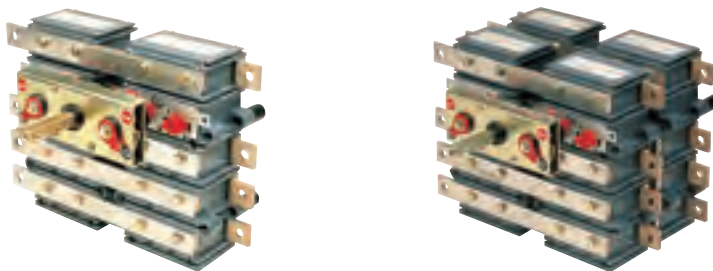

codici per ordini - ordering codes

CNP \V	250A	400A	630A	800A	1000A	1250A	1600A	1800A	2000A
3 pole	ECNP02503000V	ECNP04003000V	ECNP06303000V	ECNP08003000V	ECNP10003000V	ECNP12503000V	ECNP16003000V	ECNP18003000V	ECNP20003000V
4 pole	ECNP02504002V	ECNP04004002V	ECNP06304002V	ECNP08004002V	ECNP10004002V	ECNP12504002V	ECNP16004002V	ECNP18004002V	ECNP20004002V
6 pole	ECNP02506000V	ECNP04006000V	ECNP06306000V	ECNP08006000V	ECNP10006000V	ECNP12506000V	ECNP16006000V	ECNP18006000V	ECNP20006000V
8 pole	ECNP02508002V	ECNP04008002V	ECNP06308002V	ECNP08008002V	ECNP10008002V	ECNP12508002V	ECNP16008002V	ECNP18008002V	ECNP20008002V

Per ordinare i Deviatori (II-I) sostituire la seconda lettera C del codice con la lettera D. Esempio: ECNP01253000V diventa EDNP01253000V
 To order Deviators (II-I) replace the second letter C of code with letter D. Example: ECNP01253000V becomes EDNP01253000V

nota: per gli ordini in Italia sostituire con la J la E iniziale nel codice prodotto

CNP 250A:2000A 3-4 pole
 DNP 250A:2000A 3-4 pole

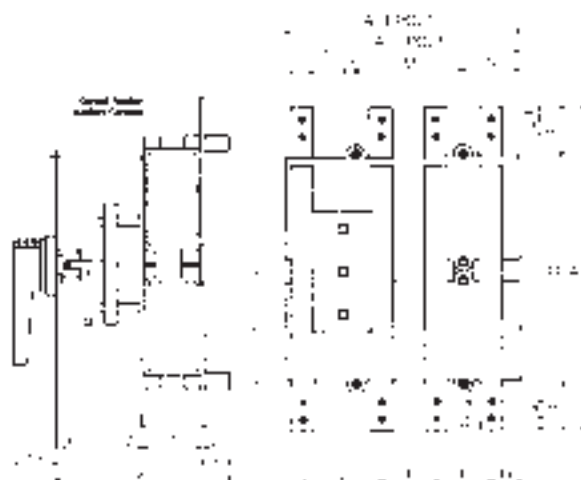

CNP 250A:2000A 6-8 pole
 DNP 250A:2000A 6-8 pole

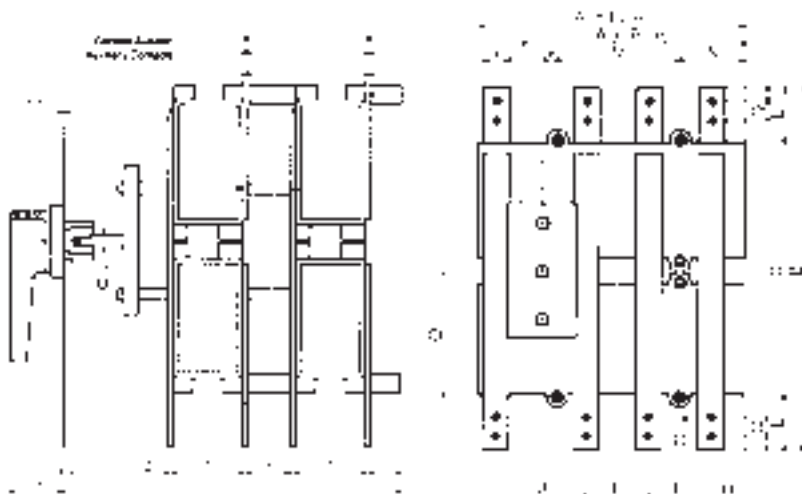

	A		B	D	E	F	H	I	J	L	M	N	O	P	Q	S		T	U	W	W ₁	X	Z	*	∅
	3-6 pole	4-8 pole														3-4 pole	6-8 pole								
CNP 250A	181	222	292	244	24	44	28	12	82	25	98	51	122	6	--	220	328	45	43	125	--	49	4	5,5	10,5
DNP 250A																									
CNP 400A	256	306	350	264	43	65	42	15	109	30	137	72	132	12	--	248	390	59	49	165	--	71	5	6,5	12,5
DNP 400A																									
CNP - DNP 630A	325	378	350	264	43	65	42	15	109	40	137	72	132	12	--	256	465	59	49	165	--	96	8	6,5	12,5
CNP - DNP 800A																									
CNP - DNP 1000A	325	378	350	264	43	65	42	15	109	40	137	72	132	12	--	256	465	59	49	165	--	92	10	6,5	12,5
CNP - DNP 1250A																									
CNP - DNP 1600A	325	378	525	379	73	87	49	20	130	40	174	92	189	18	30	256	465	77	55	--	330	80	16	6,5	12,5
CNP - DNP 1800A																									
CNP - DNP 2000A	325	378	525	379	73	87	49	20	130	40	174	92	189	18	30	256	465	77	55	--	330	76	20	6,5	12,5
DNP 2000A																									

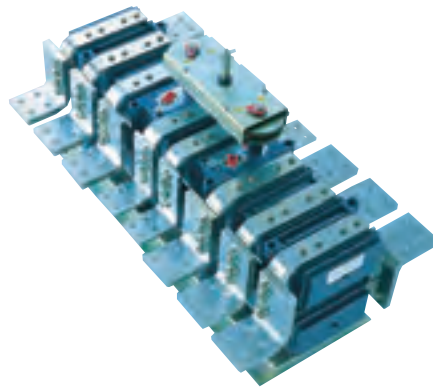

codici per ordini - ordering codes

CNP \H	2500A	3150A	4000A	5000A	6300A	7000A
3 pole	ECNP25003000O	ECNP31503000O	ECNP40003000O	ECNP50003000O	ECNP63003000O	ECNP70003000O
4 pole	ECNP25004002O	ECNP31504002O	ECNP40004002O	ECNP50004002O	ECNP63004002O	ECNP70004002O

Per ordinare i Deviatori (II-I) sostituire la seconda lettera C del codice con la lettera D. Esempio: ECNP01253000O diventa EDNP01253000O
 To order Deviators (II-I) replace the second letter C of code with letter D. Example: ECNP01253000O becomes EDNP01253000O

nota: per gli ordini in Italia sostituire con la J la E iniziale nel codice prodotto

CNP 2500A:4000A
 3-4 pole
 DNP 2500A:4000A
 3-4 pole

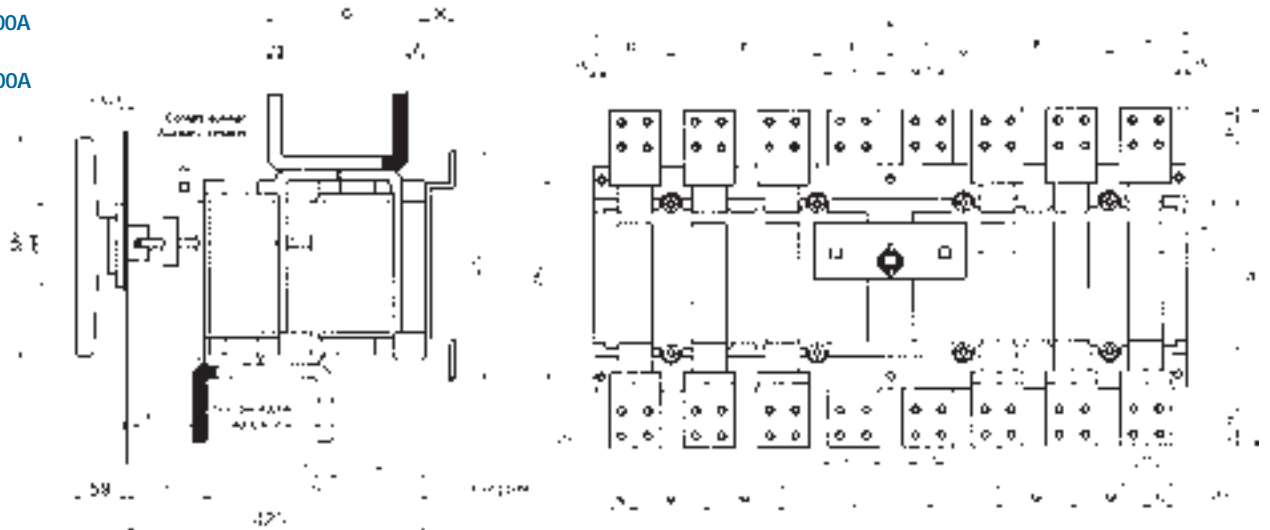

	A	A	B	C	D	E	E	F	G	H	I	L	M	N	P	P	Q	R	S	T	U	V	ØX	ØY	Z
	3 pole	4 pole				3 pole	4 pole								3 pole	4 pole									
CNP-DNP 2500A																									
CNP-DNP 3150A	726	773	174	176	93	97	120	64	435	40	20	80	107	40	241	287	190	129	280	145	60	30	9	12,5	...
CNP-DNP 4000A																									40

CNP 5000A:6300A
 3-4 pole
 DNP 5000A:6300A
 3-4 pole

nota: le quote dimensionali sono sul disegno
 note: overall dimensions indicated on the drawing

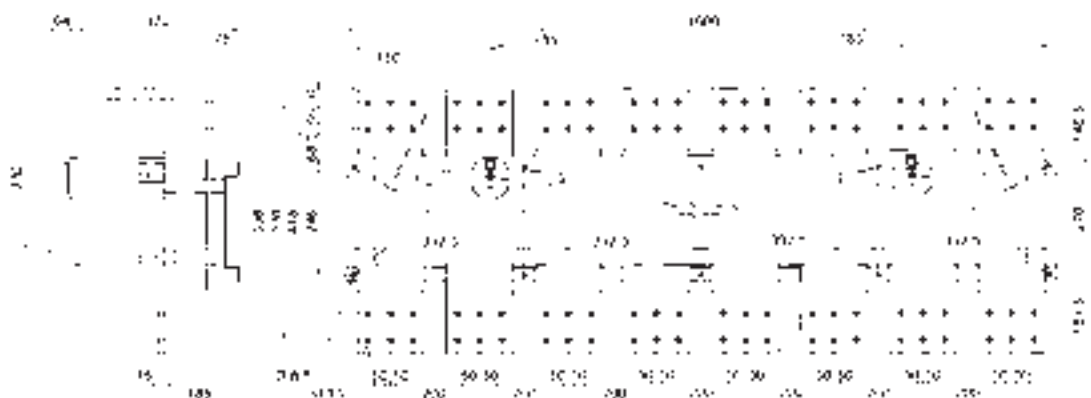

CNP 7000 A 3-4 pole
DNP 7000 A 3-4 pole

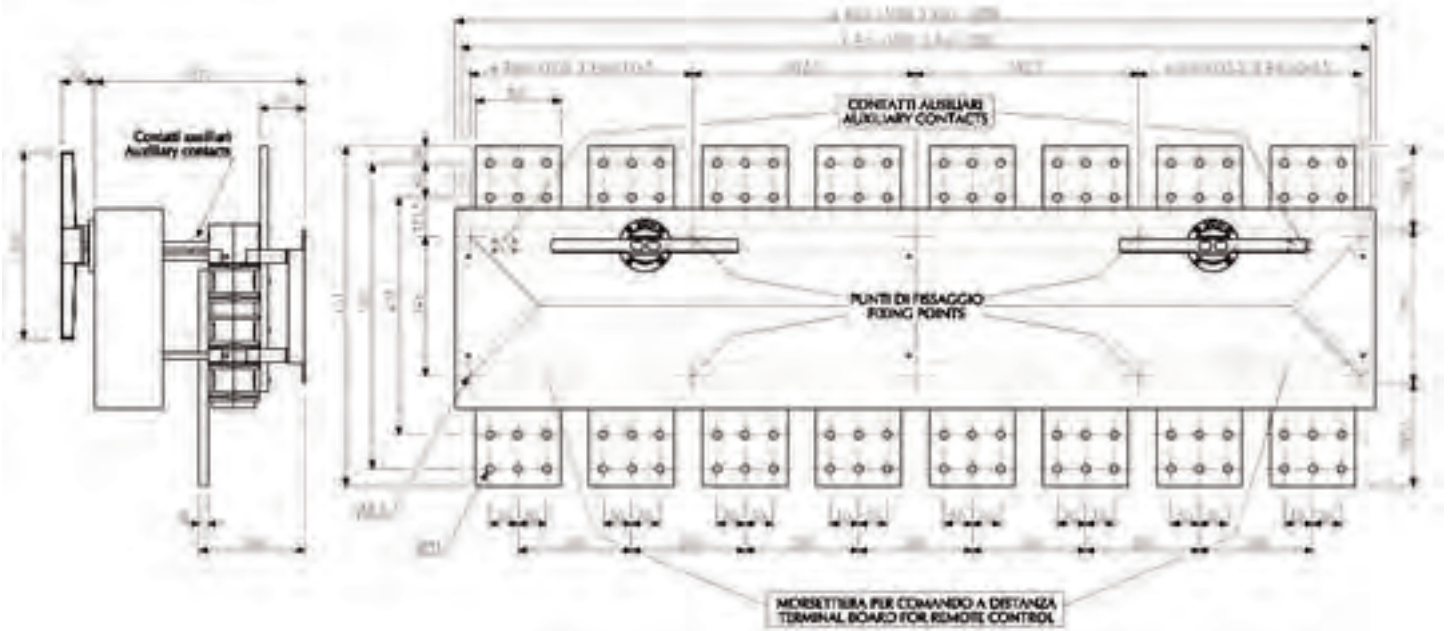



SCHEDA ELETTRONICA

- relè e cablaggi non sono più necessari
- protezioni contro anomalie
- il cliente deve solo cablare la morsettiera

ELECTRONIC CONTROL CARD

- relays and relevant wiring are not necessary
- protection against incorrect operations
- customer has only to wire terminal block

codici per ordini - ordering codes

da 220V a 240V corrente alternata
 from 220V to 240V alternating current 50/60 Hz

CMV	125A	160A	200A	250A	315A	400A	630A	800A
3 pole	ECMV01253000V	ECMV01603000V	ECMV02003000V	ECMV02503000V	ECMV03153000V	ECMV04003000V	ECMV06303000V	ECMV08003000V
4 pole	ECMV01254002V	ECMV01604002V	ECMV02004002V	ECMV02504002V	ECMV03154002V	ECMV04004002V	ECMV06304002V	ECMV08004002V
6 pole	ECMV01256000V	ECMV01606000V	ECMV02006000V	ECMV02506000V	ECMV03156000V	ECMV04006000V	ECMV06306000V	ECMV08006000V
8 pole	ECMV01258002V	ECMV01608002V	ECMV02008002V	ECMV02508002V	ECMV03158002V	ECMV04008002V	ECMV06308002V	ECMV08008002V

CMV	1000A	1250A	1600A	1800A	2000A
3 pole	ECMV10003000V	ECMV12503000V	ECMV16003000V	ECMV18003000V	ECMV20003000V
4 pole	ECMV10004002V	ECMV12504002V	ECMV16004002V	ECMV18004002V	ECMV20004002V
6 pole	ECMV10006000V	ECMV12506000V	ECMV16006000V	ECMV18006000V	ECMV20006000V
8 pole	ECMV10008002V	ECMV12508002V	ECMV16008002V	ECMV18008002V	ECMV20008002V

i commutatori motorizzati CMV da 125A a 2000A sono forniti di serie con la scheda elettronica; i deviatori motorizzati DMV sono forniti privi di schede elettronica

motor driven change-over switches CMV from 125A to 2000A are complete with electronic control card; motor driven deviators DMV are supplied without electronic control card

Per ordinare i Deviatori (II-I) sostituire la seconda lettera C del codice con la lettera D. Esempio: ECMV01253000V diventa EDMV01253000V
 To order Deviators (II-I) replace the second letter C of code with letter D. Example: ECMV01253000V becomes EDMV01253000V

Per ordinare il 24V a corrente continua sostituire la lettera finale V del codice del prodotto (CMV o DMV 220V-240V) con la lettera H
 Example: ECMV01253000V diventa ECMV01253000H

To order 24V direct current replace the letter V of CMV or DMV 220V-240V ordering code with letter H

Example: ECMV01253000V becomes ECMV01253000H

Per altre esecuzioni contattare il nostro ufficio tecnico

Please contact our technical department for other executions

nota: per gli ordini in Italia sostituire con la J la E iniziale nel codice prodotto

CMV 125A:800A 3-4 pole
 DMV 125A:800A 3-4 pole

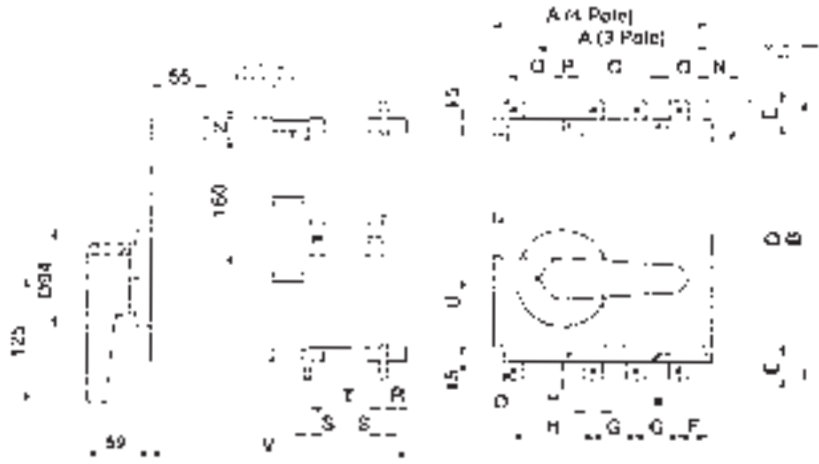

	A	A	B	C	D	E	F	G	H	I	L	N	O	P	Q	R	S	T	U	V	Z	Ø	*
	3 pole	4 pole																					
CMV 125A	181	222	270	98	244	13	32	44	82	20	8	-	51	6	44	29	3	57	122	267	18	8,5	5,5
CMV 160A																							
CMV 200A																							
CMV 250A																							
CMV 315A	256	306	306	137	264	21	42	65	109	30	12	-	72	12	44	32	4	67	132	311	18	10,5	6,5
CMV 400A																							
CMV 630A																							
CMV 800A																							
DMV 125A	181	222	270	98	244	13	32	44	82	20	8	10	51	6	44	29	3	57	122	267	18	8,5	5,5
DMV 160A																							
DMV 200A																							
DMV 250A																							
DMV 315A	256	306	306	137	264	21	42	65	109	30	12	8	72	12	44	36	4	76	132	296	18	10,5	5,5
DMV 400A																							
DMV 630A																							
DMV 800A																							

CMV 1000A:2000A 3-4 pole
 DMV 1000A:2000A 3-4 pole

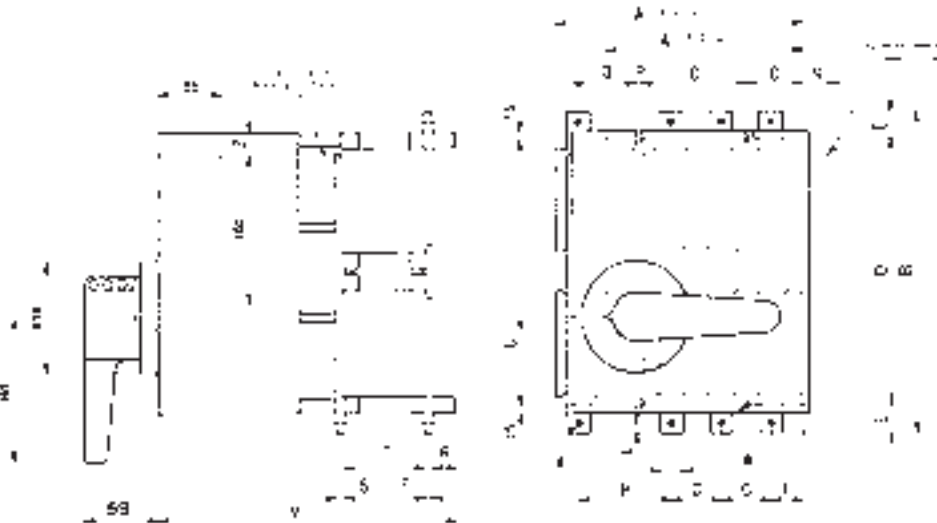

	A	A	B	C	D	E	F	G	H	I	L	M	N	O	P	Q	R	S	T	U	V	Z	Ø	*
	3 pole	4 pole																						
CMV 1000A	325	378	525	174	379	73	49	87	130	40	20	30	-	92,5	20	57	39	8	76	189	340	45	12,5	7
CMV 1250A																								
CMV 1600A																								
CMV 1800A																								
CMV 2000A																								
DMV 1000A	325	378	525	174	379	73	49	87	130	40	20	30	32	92,5	20	57	39	8	76	111	316	45	12,5	7
DMV 1250A																								
DMV 1600A																								
DMV 1800A																								
DMV 2000A																								

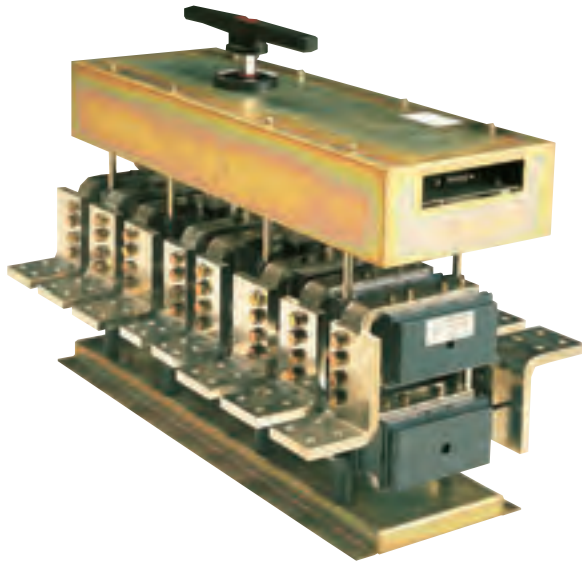

SCHEDA ELETTRONICA
 - relè e cablaggi non sono più necessari
 - protezioni contro anomalie
 - il cliente deve solo cablare la morsettiera

ELECTRONIC CONTROL CARD
 - relays and relevant wiring are not necessary
 - protection against incorrect operations
 - customer has only to wire terminal block

i commutatori motorizzati CMV da 2500A a 4000A sono forniti di serie con la scheda elettronica; i deviatori motorizzati DMV sono forniti privi di schede elettronica

motor driven change-over switches CMV from 2500A to 4000A are complete with electronic control card; motor driven deviators DMV are supplied without electronic control card

codici per ordini - ordering codes

CMV	2500A	3150A	4000A
3 pole	ECMV25003000O	ECMV31503000O	ECMV40003000O
4 pole	ECMV25004002O	ECMV31504002O	ECMV40004002O

Per ordinare i Deviatori (II-I) sostituire la seconda lettera C del codice con la lettera D. Esempio: ECMV25003000O diventa EDMV25003000O
 To order Deviators (II-I) replace the second letter C of code with letter D. Example: ECMV25003000O becomes EDMV25003000O

Per ordinare il 24V a corrente continua sostituire la lettera finale O del codice del prodotto (CMV o DMV 220V-240V) con la lettera H
 Esempio ECMV25003000O diventa ECMV25003000H

To order 24V direct current replace the letter O of CMV or DMV 220V-240V ordering code with letter H

Example: ECMV25003000O becomes ECMV25003000H

Per altre esecuzioni contattare il nostro ufficio tecnico

Please contact our technical department for other executions

nota: per gli ordini in Italia sostituire con la J la E iniziale nel codice prodotto

CMV 2500A:4000A 3-4 pole
DMV 2500A:4000A 3-4 pole

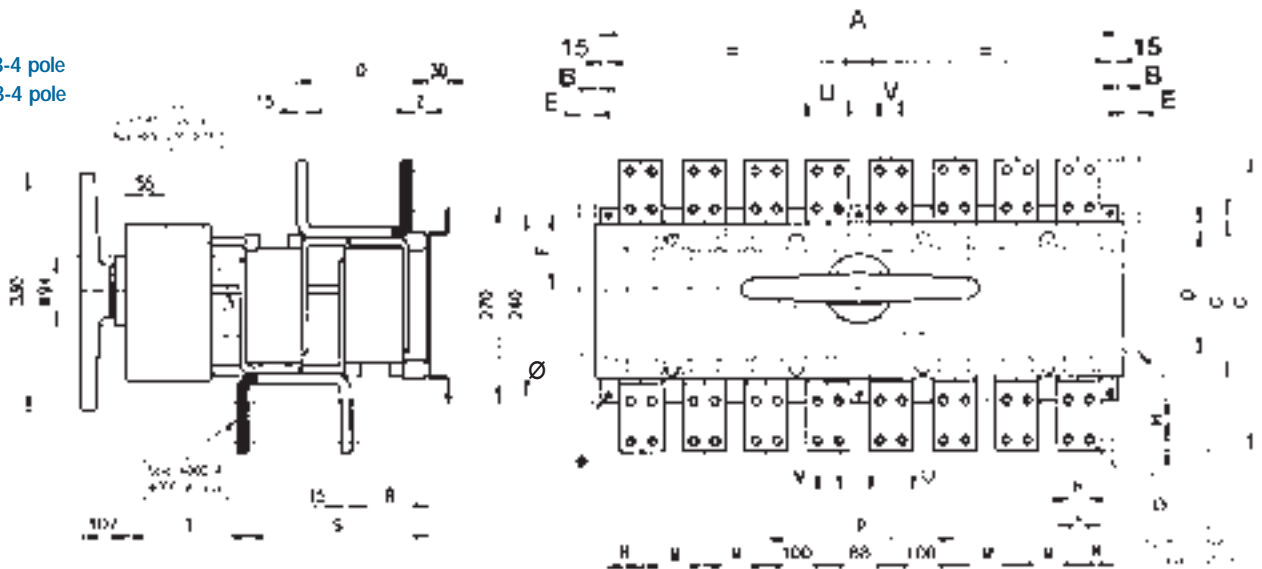

	A	B	C	D	E	F	G	H	I	L	M	N	P	Q	R	S	T	U	V	Z	Ø	*
	3-4 pole												3-4 pole									
CMV-DMV 2500A	773	2	268	160	27 (DMV)	95	440	40	20	80	107	29	288	185	129	183	319	60	30	-	12,5	9
CMV-DMV 3150A																						
CMV-DMV 4000A																						

per le tabelle dimensionali e i disegni del CMV 5000A:7000A vedi pag. 16-17
 see page 16-17 for dimensional tables and drawings of CMV 5000A:7000A



SCHEDA ELETTRONICA

- relè e cablaggi non sono più necessari
- protezioni contro anomalie
- il cliente deve solo cablare la morsettiere

ELECTRONIC CONTROL CARD

- relays and relevant wiring are not necessary
- protection against incorrect operations
- customer has only to wire terminal block

codici per ordini - ordering codes

CMV	5000A	6300A	7000A
3 pole	ECMV50003000O	ECMV63003000O	ECMV70003000O
4 pole	ECMV50004002O	ECMV63004002O	ECMV70004002O

i commutatori motorizzati CMV da 5000A a 6300A sono forniti di serie con la scheda elettronica; i deviatori motorizzati DMV sono forniti privi di schede elettronica
 motor driven change-over switches CMV from 5000A to 6300A are complete with electronic control card; motor driven deviators DMV are supplied without electronic control card

Per ordinare i Deviatori (II-I) sostituire la seconda lettera C del codice con la lettera D. Esempio: ECMV25003000O diventa EDMV25003000O
 To order Deviators (II-I) replace the second letter C of code with letter D. Example: ECMV25003000O becomes EDMV25003000O
 Per ordinare il 24V a corrente continua sostituire la lettera finale O del codice del prodotto (CMV o DMV 220V-240V) con la lettera H
 Esempio ECMV25003000O diventa ECMV25003000H
 To order 24V direct current replace the letter O of CMV or DMV 220V-240V ordering code with letter H
 Example: ECMV25003000O becomes ECMV25003000H
 Per altre esecuzioni contattare il nostro ufficio tecnico
 Please contact our technical department for other executions

nota: per gli ordini in Italia sostituire con la J la E iniziale nel codice prodotto

nota: le quote dimensionali sono sul disegno
 note: overall dimensions indicated on the drawing

Contatti ausiliari
 Auxiliary contacts

CMV 5000A:6300A 3-4 pole
 DMV 5000A:6300A 3-4 pole

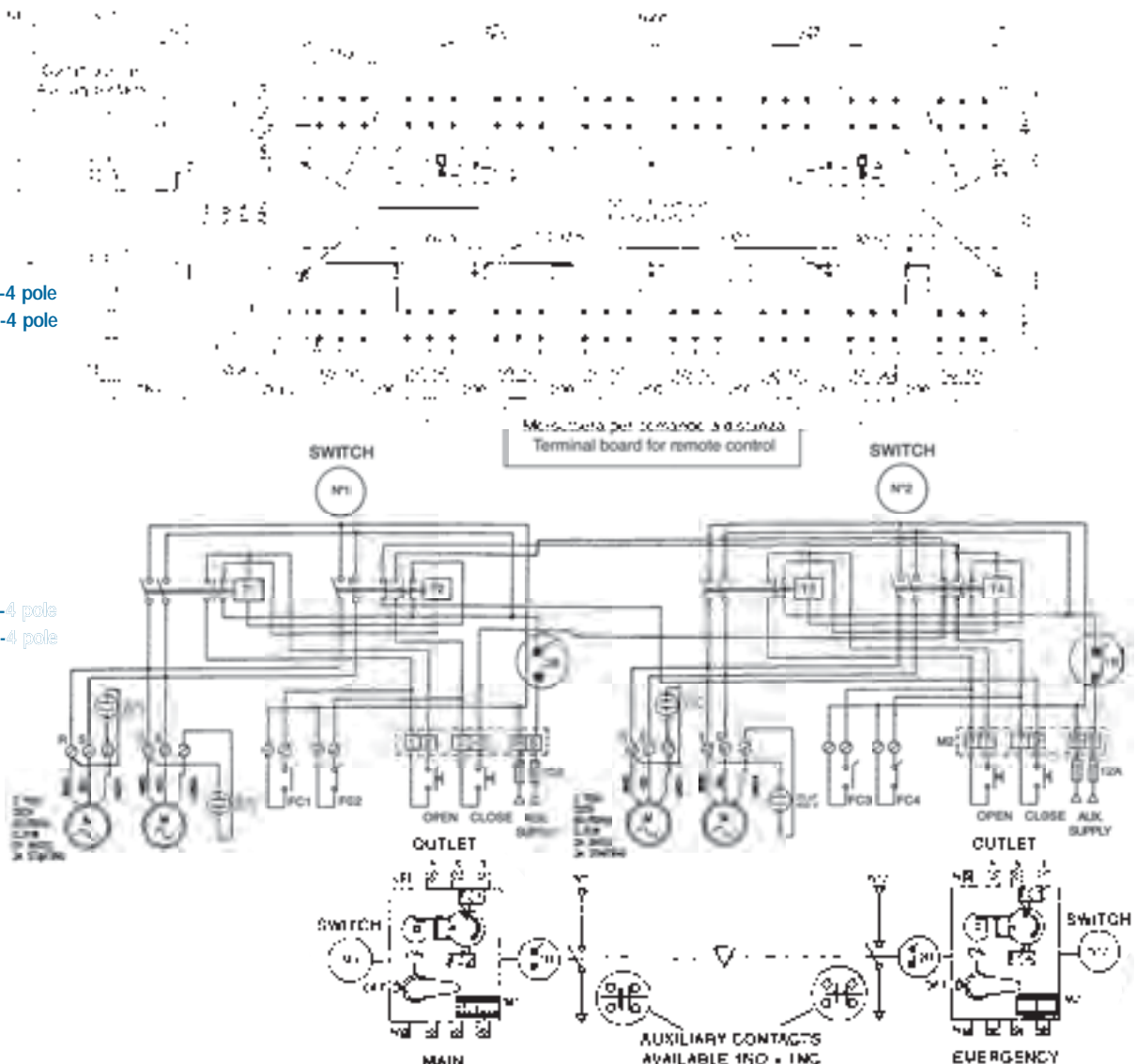

SCHEMA ELETTRICO
WIRING SCHEME

CMV 5000A:6300A 3-4 pole
 DMV 5000A:6300A 3-4 pole

CMV 7000 A 3-4 pole
DMV 7000 A 3-4 pole

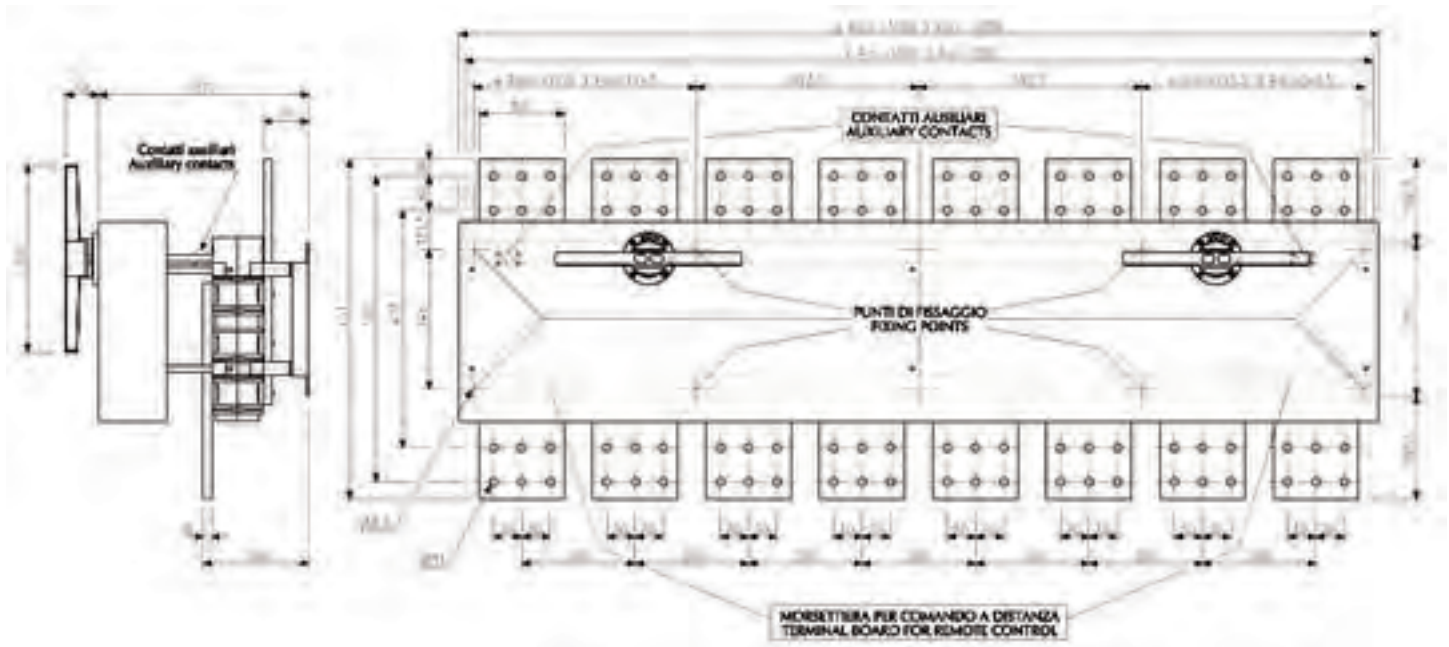

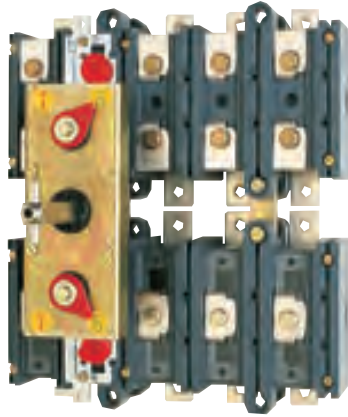

codici per ordini - ordering codes

BPV	125A	160A	200A
3 pole	EBPV01253000V	EBPV01603000V	EBPV02003000V
4 pole	EBPV01254002V	EBPV01604002V	EBPV02004002V

Per ordinare i Deviatori By-Pass (II-I) sostituire la quarta lettera **V** del codice con la lettera **D**. Esempio: EBPV01253000V diventa EBPD01253000V
 To order Deviators By-Pass (II-I) replace the fourth letter **V** of code with letter **D**. Example: EBPV01253000V becomes EBPD01253000V
 nota: per gli ordini in Italia sostituire con la J la E iniziale nel codice prodotto

BPV 125A:200A
 3-4 pole

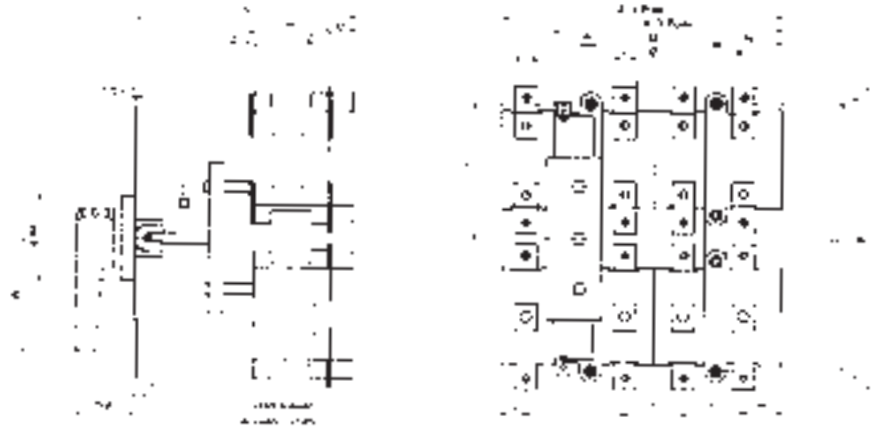

BPD 125A:200A
 3-4 pole

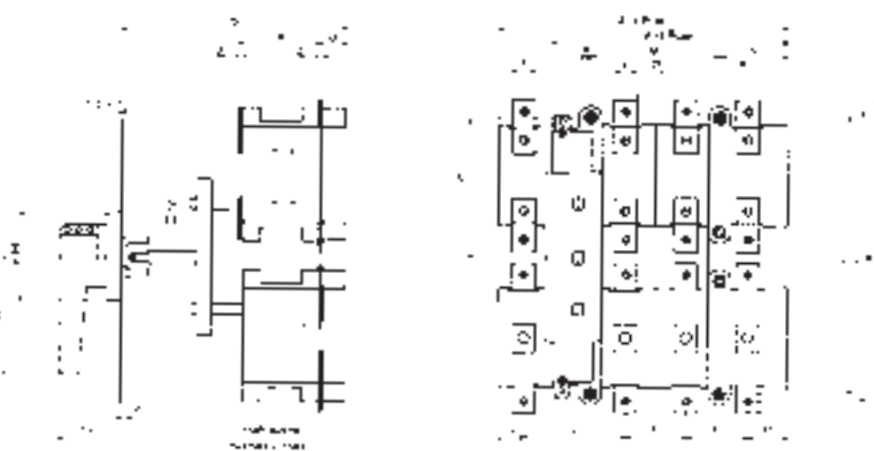

	A	A	B	C	D	F	G	H	I	J	L	M	N	O	P	R	S	U	W	Z	Ø	*
	3 pole	4 pole																				
BPV-BPD 125A																						
BPV-BPD 160A	181	222	270	252	244	44	20	32	20	82	20	98	51	122	6	57	220	29	125	3	8,5	8,5
BPV-BPD 200A																						

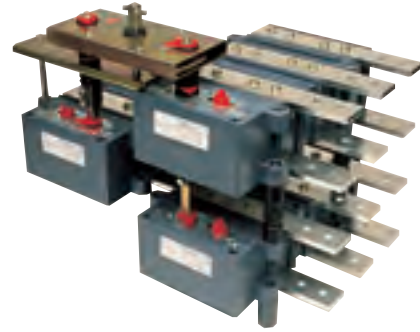

codici per ordini - ordering codes

BPV	250A	400A	630A	800A	1000A	1250A	1600A	1800A	2000A
3 pole	EBPV02503000V	EBPV04003000V	EBPV06303000V	EBPV08003000V	EBPV10003000V	EBPV12503000V	EBPV16003000V	EBPV18003000V	EBPV20003000V
4 pole	EBPV02504002V	EBPV04004002V	EBPV06304002V	EBPV08004002V	EBPV10004002V	EBPV12504002V	EBPV16004002V	EBPV18004002V	EBPV20004002V

Per ordinare i Deviatori By-Pass (II-I) sostituire la quarta lettera **V** del codice con la lettera **D**. Esempio: EBPV02503000V diventa EBPD02503000V
 To order Deviators By-Pass (II-I) replace the fourth letter **V** of code with letter **D**. Example: EBPV02503000V becomes EBPD02503000V

nota: per gli ordini in Italia sostituire con la J la E iniziale nel codice prodotto

BPV 250A:2000A 3-4 pole

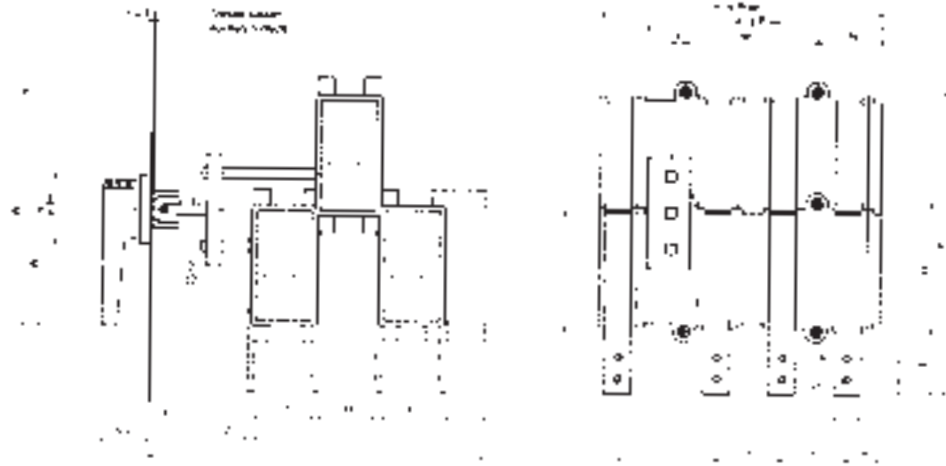

BPD 250A:2000A 3-4 pole

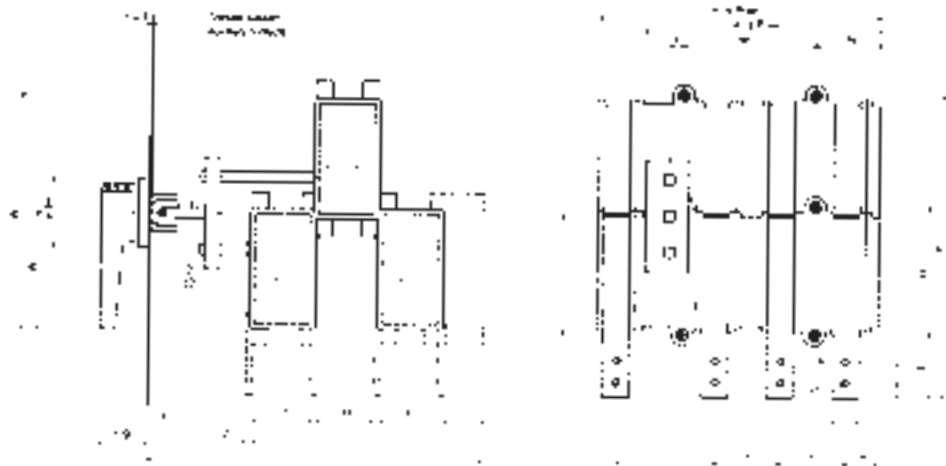

	A	A	B	D	E	F	H	I	J	L	M	N	O	P	Q	R	S	U	W	w ₁	Z	∅	*
	3 pole	4 pole																					
BPV-BPD 250A	181	222	276	107	24	44	28	12	82	25	98	51	122	6	...	59	345	63	165	10,5	5,5
BPV-BPD 400A																							
BPV-BPD 630A	256	306	318	119	43	65	42	15	109	30	137	72	132	12	...	59	400	69	165	12,5	6,5
BPV-BPD 800A																							
BPV-BPD 1000A	325	378	463	176	73	87	49	20	130	40	174	92	189	18	30	77	421	58	165	...	8	12,5	7
BPV-BPD 1250A																	425	56	10		
BPV-BPD 1600A																	437	50	16		
BPV-BPD 1800A	325	378	463	176	73	87	49	20	130	40	174	92	189	18	30	77	441	48	...	330	16	12,5	7
BPV-BPD 2000A																	445	46	20		



SCHEDA ELETTRONICA

- relè e cablaggi non sono più necessari
- protezioni contro anomalie
- il cliente deve solo cablare la morsettiera

ELECTRONIC CONTROL CARD

- relays and relevant wiring are not necessary
- protection against incorrect operations
- customer has only to wire terminal block

i commutatori motorizzati By-Pass BPM da 125A a 200A sono forniti di serie con la scheda elettronica; i deviatori motorizzati By-Pass BMD sono forniti privi di schede elettronica

motor driven change-over switches By-Pass BPM from 125A to 200A are complete with electronic control card; motor driven deviators By-Pass BMD are supplied without electronic control card

codici per ordini - ordering codes

BPM	125A	160A	200A
3 pole	EBPM01253000V	EBPM01603000V	EBPM02003000V
4 pole	EBPM01254002V	EBPM01604002V	EBPM02004002V

Per ordinare i Deviatori by pass (II-I) sostituire la terza e quarta lettera **PM** del codice con le lettere **MD**. Esempio: EBPM01253000V diventa EBMD01253000V
 To order By-Pass Deviators (II-I) replace the third and fourth letters **PM** of code with letters **MD**. Example: EBPM01253000V becomes EBMD01253000V

Per ordinare il 24V a corrente continua sostituire la lettera finale **V** del codice del prodotto (BPM o BMD 220V-240V) con la lettera **H**

Esempio EBPM01253000V diventa EBPM01253000H

To order 24V direct current replace the letter **V** of BPM or BMD 220V-240V ordering code with letter **H**

Example: EBPM01253000V becomes EBPM01253000H

Per altre esecuzioni contattare il nostro ufficio tecnico

Please contact our technical department for other executions

nota: per gli ordini in Italia sostituire con la J la E iniziale nel codice prodotto

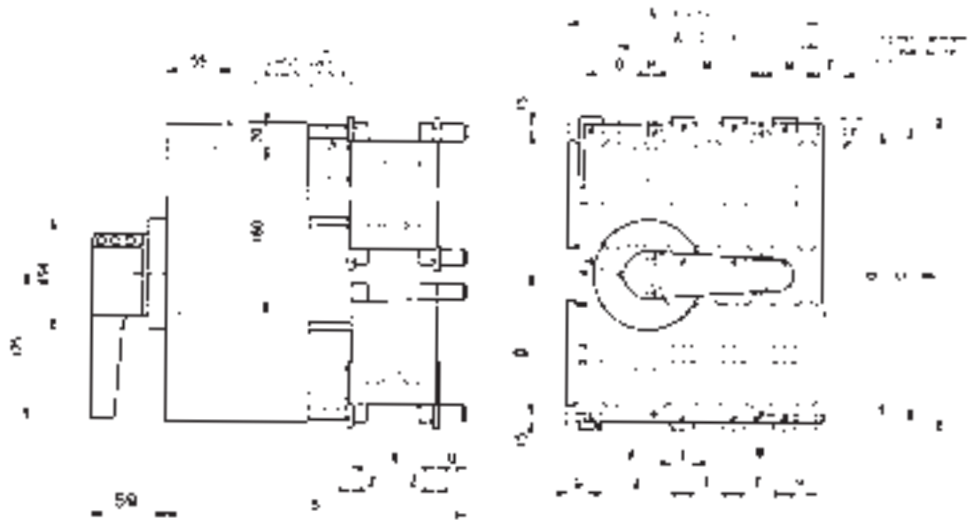

BPM 125A:200A 3-4 pole
 BMD 125A:200A 3-4 pole

	A	A	B	C	D	E	F	G	H	I	J	M	N	O	P	Q	R	S	U	Z	Ø	*
	3 pole	4 pole																				
BPM 125A	181	222	270	252	244	-	44	20	32	20	82	98	51	122	6	44	57	283	29	3	8,5	5,5
BPM 160A																						
BPM 200A																						
BMD 125A	181	222	270	252	244	10	44	20	32	20	82	98	51	122	6	44	57	283	29	3	8,5	5,5
BMD 160A																						
BMD 200A																						

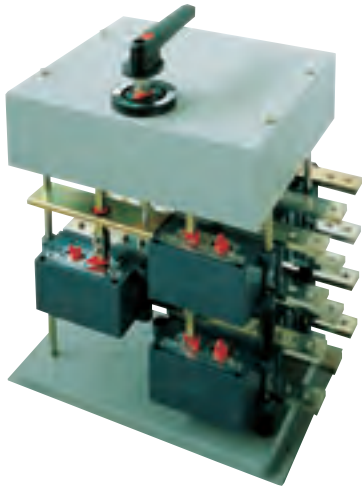

SCHEDA ELETTRONICA

- relè e cablaggi non sono più necessari
- protezioni contro anomalie
- il cliente deve solo cablare la morsettiera

ELECTRONIC CONTROL CARD

- relays and relevant wiring are not necessary
- protection against incorrect operations
- customer has only to wire terminal block

i commutatori motorizzati By-Pass BPM da 250A a 2000A sono forniti di serie con la scheda elettronica; i deviatori motorizzati By-Pass BMD sono forniti privi di schede elettronica

motor driven change-over switches By-Pass BPM from 250A to 2000A are complete with electronic control card; motor driven deviators By-Pass BMD are supplied without electronic control card

codici per ordini - ordering codes

BPM	250A	400A	630A	800A	1000A	1250A	1600A	1800A	2000A
3 pole	EBPM02503000V	EBPM04003000V	EBPM06303000V	EBPM08003000V	EBPM10003000V	EBPM12503000V	EBPM16003000V	EBPM18003000V	EBPM20003000V
4 pole	EBPM02504002V	EBPM04004002V	EBPM06304002V	EBPM08004002V	EBPM10004002V	EBPM12504002V	EBPM16004002V	EBPM18004002V	EBPM20004002V

Per ordinare i Deviatori By-Pass (II-I) sostituire la terza e quarta lettera **PM** del codice con le lettere **MD**. Esempio: EBPM02503000V diventa EBMD02503000V
 To order By-Pass Deviators (II-I) replace the third and fourth letters **PM** of code with letters **MD**. Example: EBPM02503000V becomes EBMD02503000V

Per ordinare il 24V a corrente continua sostituire la lettera finale **V** del codice del prodotto (BPM o BMD 220V-240V) con la lettera **H**

Esempio EBPM02503000V diventa EBPM02503000H

To order 24V direct current replace the letter **V** of BPM or BMD 220V-240V ordering code with letter **H**

Example: EBPM02503000V becomes EBPM02503000H

Per altre esecuzioni contattare il nostro ufficio tecnico

Please contact our technical department for other executions

nota: per gli ordini in Italia sostituire con la J la E iniziale nel codice prodotto

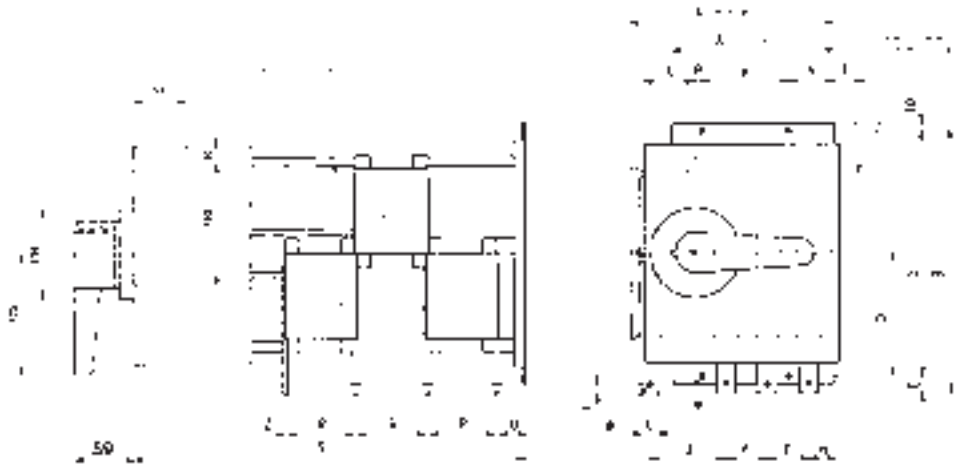

BPM 250A:800A 3-4 pole
 BMD 250A:800A 3-4 pole

	A	A	B	C	D	E	F	H	I	J	L	M	N	O	P	R	S	T	U	Z	Ø	*
	3 pole	4 pole																				
BPM 250A	181	222	301	44	294	7	44	32	12	82	25	98	30	147	6	59	453	--	43	4	10,5	6
BPM 400A																				5		
BPM 630A	256	306	351	44	330	21	65	42	15	109	30	137	50	165	12	59	453	--	49	5	12,5	8,5
BPM 800A																				10		
BMD 250A	181	222	301	44	294	7	44	32	12	82	25	98	30	147	6	59	438	7	43	4	10,5	6
BMD 400A																				5		
BMD 630A	256	306	351	44	330	21	65	42	15	109	30	137	50	165	12	59	438	7	49	5	12,5	8,5
BMD 800A																				10		

per le tabelle dimensionali e i disegni del BPM 1000A:2000A vedi pag. 22
 see page 22 for dimensional tables and drawings of BPM 1000A:2000A

BPM 1000A:2000A 3-4 pole
 BMD 1000A:2000A 3-4 pole

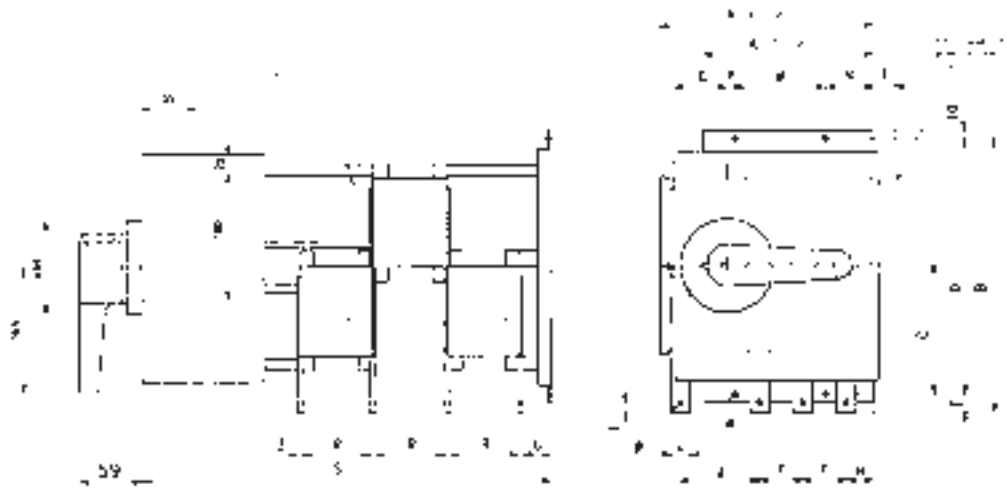

	A	A	B	C	D	E	F	H	I	J	L	M	N	O	P	Q	R	S	T	U	Z	∅	*
	3 pole	4 pole																					
BPM 1000A																					8		
BPM 1250A																					10		
BPM 1600A	325	378	498	57	449	49	87	49	20	130	40	174	60	225	18	30	77	523	...	55	16	12,5	8,5
BPM 1800A																					16		
BPM 2000A																					20		
BMD 1000A																					8		
BMD 1250A																					10		
BMD 1600A	325	378	498	57	449	49	87	49	20	130	40	174	60	225	18	30	77	508	25	55	16	12,5	8,5
BMD 1800A																					16		
BMD 2000A																					20		

caratteristiche tecniche - technical characteristics

CKF\CMF

TIPO (SERIE) - TYPE (SERIES)		IMF	IMF	IMF	IMF	IMF	IMF	IMF	IMF	IMF	IMF	IMF	IMF
CORRENTE NOMINALE A T.A. MAX 40° RATED THERMAL CURRENT AT 40° MAX A.T.	I _{th}	in aria libera free air	A	125	IMF	160	250	400	IMF	630	800	1000	1250
		in cassetta box	A	110	IMF	150	200	340	IMF	550	630	700	900
TENSIONE D'ISOLAMENTO - RATED VOLTAGE OF ISOLATION	U _i	c.a./a.c. c.c./d.c.	V	1000 660	IMF	1000 660	1000 660	1000 660	IMF	1000 660	1000 660	1000 660	1000 660
			kV	8	IMF	8	8	8	IMF	8	8	8	8
TENSIONE DI TENUTA AD IMPULSO - IMPULSE WITHSTAND VOLTAGE	I _e	415 V 500 V 690 V	A/kW	125/55 125/75 125/90	IMF	160/75 160/100 160/140	250/132 250/160 250/220	400/200 400/280 400/375	IMF	630/355 630/425 630/560	800/400 800/560 800/710	1000/600 1000/670 800/710	1250/600 1000/670 800/710
	I _e	690 V 1000 V	A	125	IMF	160	250	400	IMF	630	800	1000	1250
CORRENTE D'IMPIEGO - OPERATIONAL CURRENT AC23A	I _e	220 V 440 V 600 V	A	125 125 125	IMF	160 160 160	250 250 250	400 400 400	IMF	630 630 630	800 800 800	1000 1000 1000	1250 1250 1250
					IMF				IMF				
POTENZA REATTIVA - REACTIVE POWER note (1)		380 V	kVar	60	IMF	75	125	250	IMF	315	350	380	400
POTERE DI CHIUSURA CONDIZIONATO DA FUSIBILE RATED SHORT-CIRCUIT MAKING CAPACITY	I _{cm}	690 V	kA peak	100	IMF	100	100	100	IMF	100	100	100	100
DURATA MECCANICA - MECHANICAL ENDURANCE		operazioni - operations	n°	8000	IMF	8000	8000	5000	IMF	5000	3000	3000	3000
		operazioni - operations	n°	1000	IMF	1000	1000	1000	IMF	1000	500	500	500
VITA ELETTRICA - ELECTRICAL LIFE			(sec)	3	IMF	3	3	3	IMF	3	3	3	3
TEMPI DI MANOVRA O-I - OPERATING TIME O-I				00-0	IMF	00-0	1-2	1-2	IMF	3	4	4	4
FUSIBILI - FUSE TYPE		DIN 43620 NFC 62210 BS 88		22x58	IMF				IMF				
			W	A4	IMF	B1-B2	B1-B3	B1-B4	IMF	C1-C2	C3-D1	D1	D1
POTENZA DISSIPATA PER POLO - POWER LOSSES FOR POLE				4,8	IMF	6,6	12	28	IMF	40	41	64	100
PESO - WEIGHT IMF 3 pole 24V dc note (2) and 220V/240V ac note (3)		NFC 62210	Kg	5,6 (2) 5,8 (3)	IMF	5,6 (2) 5,8 (3)	6,9 (2) 6,9 (3)	9,1 (2) 10,3 (3)	IMF	13,8 (2) 13,8 (3)	20,7 (2) 21,9 (3)	21,3 (2) 22,5 (3)	22,3 (2) 23,5 (3)
PESO - WEIGHT IMF 3 pole - con scheda elettronica - with control card 24V dc note (2) and 220V/240V ac note (3)		NFC 62210	Kg	6,6 (2) 6,8 (3)	IMF	6,6 (2) 6,8 (3)	6,9 (2) 6,9 (3)	10,1 (2) 11,3 (3)	IMF	13,6 (2) 14,8 (3)	21,7 (2) 22,9 (3)	22,3 (2) 23,5 (3)	23,3 (2) 24,5 (3)
PESO - WEIGHT IMF 4 pole 24V dc note (2) and 220V/240V ac note (3)		NFC 62210	Kg	6,2 (2) 6,4 (3)	IMF	6,2 (2) 6,4 (3)	7,5 (2) 7,5 (3)	10,1 (2) 11,3 (3)	IMF	19,1 (2) 20,3 (3)	29,9 (2) 25,1 (3)	24,6 (2) 25,8 (3)	25,9 (2) 27,1 (3)
PESO - WEIGHT IMF 4 pole - con scheda elettronica - with control card 24V dc note (2) and 220V/240V ac note (3)		NFC 62210	Kg	7,2 (2) 7,4 (3)	IMF	7,2 (2) 7,4 (3)	7,4 (2) 7,4 (3)	11,1 (2) 12,3 (3)	IMF	20,1 (2) 21,3 (3)	24,9 (2) 26,1 (3)	25,6 (2) 26,8 (3)	26,9 (2) 28,1 (3)
PESO - WEIGHT IMF 3 pole 24V dc note (2) and 220V/240V ac note (3)		DIN 43620	Kg	5,7 (2) 5,9 (3)	IMF	5,7 (2) 5,9 (3)	5,9 (2) 5,9 (3)	9,1 (2) 10,3 (3)	IMF	12,6 (2) 13,8 (3)	20,7 (2) 21,9 (3)	21,3 (2) 22,5 (3)	22,3 (2) 23,5 (3)
PESO - WEIGHT IMF 3 pole - con scheda elettronica - with control card 24V dc note (2) and 220V/240V ac note (3)		DIN 43620	Kg	6,7 (2) 6,9 (3)	IMF	6,7 (2) 6,9 (3)	6,9 (2) 6,9 (3)	10,1 (2) 11,3 (3)	IMF	13,6 (2) 14,8 (3)	21,7 (2) 22,9 (3)	22,3 (2) 23,5 (3)	23,3 (2) 24,5 (3)
PESO - WEIGHT IMF 4 pole 24V dc note (2) and 220V/240V ac note (3)		DIN 43620	Kg	6,3 (2) 6,5 (3)	IMF	6,3 (2) 6,5 (3)	6,5 (2) 6,5 (3)	10,1 (2) 11,3 (3)	IMF	19,1 (2) 20,3 (3)	29,9 (2) 25,1 (3)	24,6 (2) 25,8 (3)	25,9 (2) 27,1 (3)
PESO - WEIGHT IMF 4 pole - con scheda elettronica - with control card 24V dc note (2) and 220V/240V ac note (3)		DIN 43620	Kg	7,3 (2) 7,5 (3)	IMF	7,3 (2) 7,5 (3)	7,5 (2) 7,5 (3)	11,1 (2) 12,3 (3)	IMF	20,1 (2) 21,3 (3)	24,9 (2) 26,1 (3)	25,6 (2) 26,8 (3)	26,9 (2) 28,1 (3)
PESO - WEIGHT IMF 3 pole 24V dc note (2) and 220V/240V ac note (3)		BS 88	Kg	5,8 (2) 6 (3)	IMF	5,8 (2) 6 (3)	6 (2) 6 (3)	9,4 (2) 10,6 (3)	IMF	14 (2) 15,2 (3)	21,7 (2) 22,9 (3)	22,3 (2) 23,5 (3)	23,3 (2) 24,5 (3)
PESO - WEIGHT IMF 3 pole - con scheda elettronica - with control card 24V dc note (2) and 220V/240V ac note (3)		BS 88	Kg	6,8 (2) 7 (3)	IMF	6,8 (2) 7 (3)	7 (2) 7 (3)	10,4 (2) 11,6 (3)	IMF	15 (2) 16,2 (3)	22,7 (2) 23,9 (3)	23,3 (2) 24,5 (3)	24,3 (2) 26,5 (3)
PESO - WEIGHT IMF 4 pole 24V dc note (2) and 220V/240V ac note (3)		BS 88	Kg	6,3 (2) 6,4 (3)	IMF	6,3 (2) 6,4 (3)	6,4 (2) 6,4 (3)	10,3 (2) 11,5 (3)	IMF	20,5 (2) 22 (3)	24,7 (2) 25,9 (3)	25,4 (2) 26,6 (3)	26,7 (2) 27,9 (3)
PESO - WEIGHT IMF 4 pole - con scheda elettronica - with control card 24V dc note (2) and 220V/240V ac note (3)		BS 88	Kg	7,3 (2) 7,4 (3)	IMF	7,3 (2) 7,4 (3)	7,4 (2) 7,4 (3)	11,3 (2) 12,5 (3)	IMF	21,5 (2) 23 (3)	25,7 (2) 26,9 (3)	26,4 (2) 27,6 (3)	27,7 (2) 28,9 (3)

note (1) a causa delle armoniche e delle tolleranze dei condensatori, i valori nominali devono essere ridotti del 33% - due to harmonics and tolerance of the capacitors, the rated values have been reduced by 33%

fusibili esclusi dalla fornitura
fuses out of supply

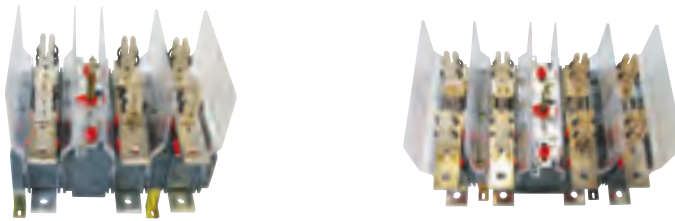

CKF (II-0-I)
COMMUTATORI
CHANGE-OVER SWITCHES

per fusibili Din
for Din fuses

codici per ordini - ordering codes

CKF	125A NHO	125A NH00	160A NHO	160A NH00	250A	400A	630A	800A	1000A	1250A
3 pole	ECKF01253010A	ECKF01253020A	ECKF01603010A	ECKF01603020A	ECKF02503030A	ECKF04003040A	ECKF06303050A	ECKF08003080A	ECKF10003080A	ECKF12503080A
4 pole	ECKF01254012A	ECKF01254022A	ECKS01604012A	ECKF01604022A	ECKF02504032A	ECKF04004042A	ECKF06304052A	ECKF08004082A	ECKF10004082A	ECKF12504082A



CMF (II-0-I)
COMMUTATORI MOTORIZZATI
MOTOR DRIVEN
CHANGE-OVER SWITCHES

per fusibili Din
for Din fuses

codici per ordini - ordering codes

da 220V a 240V corrente alternata
from 220V to 240V alternating current 50/60 Hz

CMF	125A NHO	125A NH00	160A NHO	160A NH00	250A	400A	630A	800A	1000A	1250A
3 pole	ECMF01253010A	ECMF01253020A	ECMF01603010A	ECMF01603020A	ECMF02503030A	ECMF04003040A	ECMF06303050A	ECMF08003080A	ECMF10003080A	ECMF12503080A
4 pole	ECMF01254012A	ECMF01254022A	ECMF01604012A	ECMF01604022A	ECMF02504032A	ECMF04004042A	ECMF06304052A	ECMF08004082A	ECMF10004082A	ECMF12504082A

completi di
scheda elettronica
di controllo
complete with
electronic control card

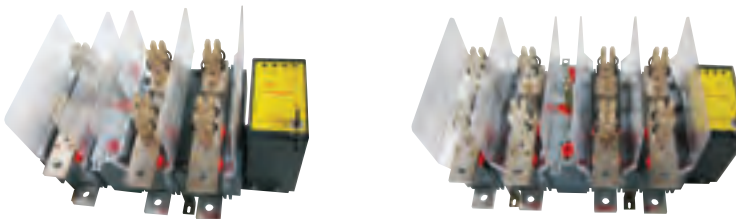

CMF_S (II-0-I)
COMMUTATORI MOTORIZZATI
MOTOR DRIVEN
CHANGE-OVER SWITCHES

per fusibili Din
for Din fuses

codici per ordini - ordering codes

da 220V a 240V corrente alternata
from 220V to 240V alternating current 50/60 Hz

CMF _S	125A NHO	125A NH00	160A NHO	160A NH00	250A	400A	630A	800A	1000A	1250A
3 pole	ECMF01253010S	ECMF01253020S	ECMF01603010S	ECMF01603020S	ECMF02503030S	ECMF04003040S	ECMF06303050S	ECMF08003080S	ECMF10003080S	ECMF12503080S
4 pole	ECMF01254012S	ECMF01254022S	ECMF01604012S	ECMF01604022S	ECMF02504032S	ECMF04004042S	ECMF06304052S	ECMF08004082S	ECMF10004082S	ECMF12504082S

Per ordinare i Deviatori (II-I) sostituire la seconda lettera C del codice con la lettera D - To order Deviators (II-I) replace the second letter C of code with letter D
Esempio: (CKF) ECKF01253000A diventa EDKF01253000A Example: (CKF) ECKF01253000A becomes EDKF01253000A
(CKM) ECMF01253000A diventa EDMF01253000A (CKM) ECMF01253000A becomes EDMF01253000A
(CKM_S) ECMF01253000S diventa EDMF01253000S (CKM_S) ECMF01253000A becomes EDMF01253000S

Per ordinare il 24V a corrente continua sostituire la lettera finale A (CMF o DMF 220V-240V) con la lettera H, o la lettera finale S (CMF_S o DMF_S 220V-240V) con la lettera T. Esempio ECMF01253000A diventa ECMF01253000H oppure ECMF01253000S diventa ECMF01253000T

To order 24V direct current replace the letter A of CMF or DMF 220V-240V ordering code with letter H or replace the letter S of CMF_S or DMF_S 220V-240V ordering code with letter T. Example: ECMF01253000A becomes ECMF01253000H or ECMF01253000S becomes ECMF01253000T

Per altre esecuzioni contattare il nostro ufficio tecnico
Please contact our technical department for other executions

nota: per gli ordini in Italia sostituire con la J la E iniziale nel codice prodotto

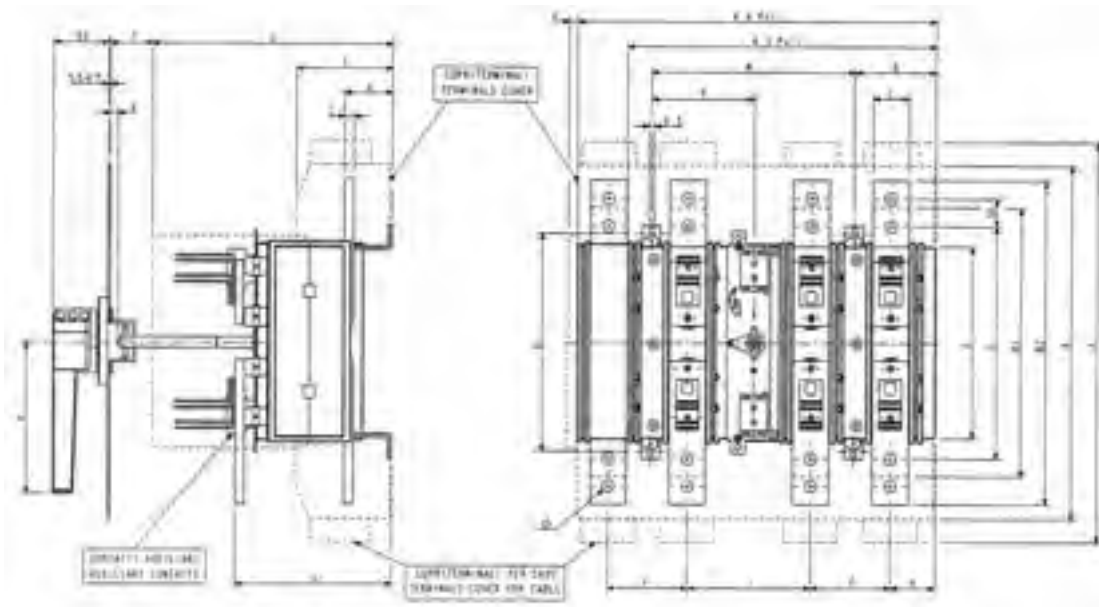

		A	A	B ₁	B ₂	C	D	E	F	G	H	I	J	K	L	M	N	O	P	S	T	U	V	X	Z	□	∅
		3 pole	4 pole																								
CKF	125A	202	230	174	---	154	172	1235	44	129	32,5	92	---	125	20	136	51,5	187	71,5	87	36	44	---	214	3	10	8,5
CKF	160A																										
CKF	250A													25											4		
CKF	315A	260	307	220	---	190	200	150	65	150	39,5	112	320	125	30	177	72	229	96	92	40	43	7,8	274	5	10	10,5
CKF	400A														30										5		
CKF	630A																				40				6		
CKF	800A	320	392	292	---	252	263	208	87	156	49	134	435	166	40	221	89	259	112	101					8	12	13
CKF	1000A																				62	48	68	284	10		
CKF	1250A				---	352																					

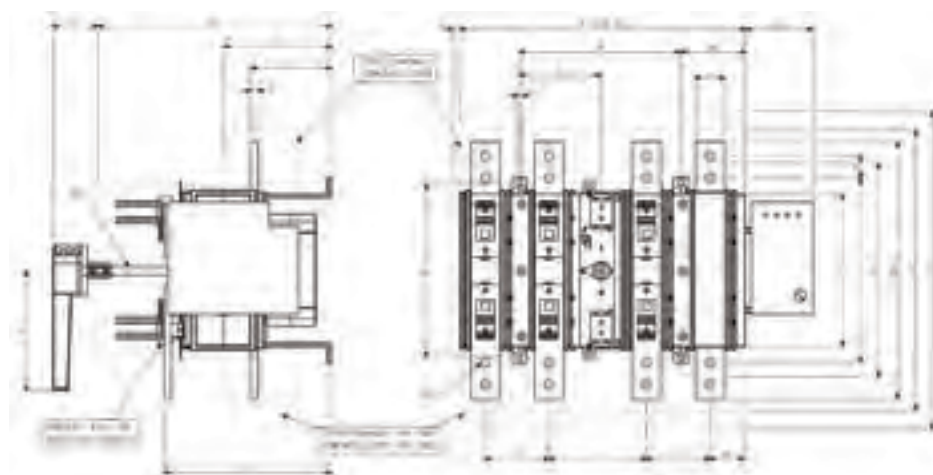

		A	B ₁	B ₂	C	D	E	F	G	H	I	J	K	L	M	N	O	P	S	T	U	V	X	Z	□	∅	Ω
		3-4 pole																									
CKF	125A	230	174	---	154	172	1235	44	167	32,5	92	---	125	20	136	51,5	225	71,5	125	81	85	---	214	3	10	8,5	8,5
CKF	160A																										
CKF	250A													25										4			
CKF	315A	307	220	---	190	200	150	65	185	39,5	112	320	125	30	177	72	264	96	125	85	80	7,8	274	5	10	10,5	10,5
CKF	400A													30										5			
CKF	630A																				85				6		
CKF	800A	392	292	---	252	263	208	87	206	49	134	435	166	40	221	89	309	112	150					8	12	13	13
CKF	1000A																				107	93	68	384	10		
CKF	1250A			---	352																						

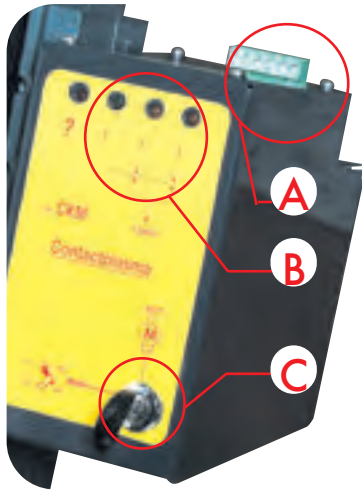

SCHEDA ELETTRONICA - ELECTRONIC CARD

CARATTERISTICHE E VANTAGGI	CHARACTERISTICS AND ADVANTAGES	ACCESSORI STANDARD	STANDARD ACCESSORIES
<p>i relé e il cablaggi non sono più necessari</p> <p>protezione contro le anomalie</p> <p>impossibilità di effettuare manovre elettriche in condizioni anomale</p> <p>segnalazione delle anomalie</p> <p>selettore con chiave manuale-elettrico</p> <p>il cliente finale deve solo cablare la morsettiera</p>	<p>relays and relevant wiring are not necessary</p> <p>protection against incorrect operations</p> <p>the motor driven operations are prevented during abnormal conditions</p> <p>abnormal conditions signalling through LED</p> <p>the manual - automatic selector key is already included in the supply</p> <p>the final costumer has only to wire the terminal block</p>	<p>n° 3 LED di segnalazione posizioni (I-0-II)</p> <p>n° 1 LED di segnalazione delle anomalie</p> <p>n° 1 selettore con chiave manuale-elettrico</p> <p>n° 2 morsetti per segnalazione a distanza</p>	<p>n° 3 position signalling (I-0-II) LEDs</p> <p>n° 1 abnormal condition signalling LEDs (?)</p> <p>n° 1 manual-automatic selector key</p> <p>n° 2 available terminals for remote signalling</p>

A	B	C
Morsettiera Terminal Block	Led di segnalazione signalling LEDs	Selettore con chiave comando manuale - elettrico manual-automatic key selector

COMMUTATORI ORIZZONTALI HORIZONTAL CHANGE-OVER SWITCHES

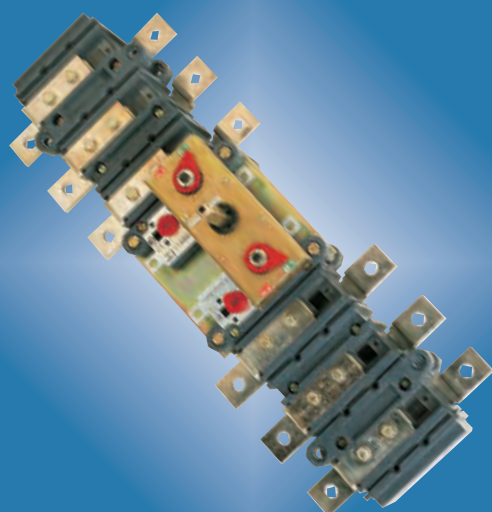
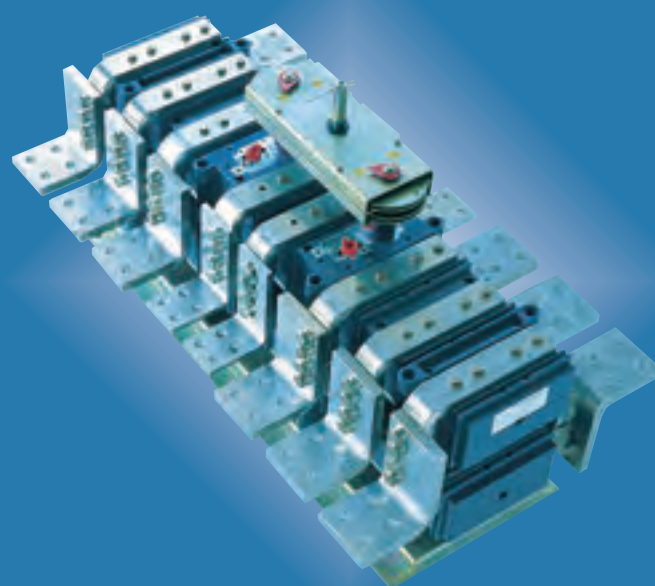

CORRENTE NOMINALE A T.A. MAX 40C° RATED THERMAL CURRENT AT 40°C MAX A. I.	I _{th}	in aria libera free air	A	63	100	125	160	200	250	315	400	630	800	1000
		in cassetta box	A	63	100	125	150	160	250	300	340	550	630	800
NUMERO DEI POLI - NUMBER OF POLES		----	----	3-4-6-8	3-4-6-8	3-4-6-8	3-4-6-8	3-4-6-8	3-4-6-8	3-4-6-8	3-4-6-8	3-4-6-8	3-4-6-8	3-4-6-8
TENSIONE D'ISOLAMENTO - RATED VOLTAGE OF ISOLATION U _i	U _i	c.a./a.c. c.c./d.c.	V	1000 600	1000 600	1000 600	1000 600	1000 600	1000 600	1000 600	1000 600	1000 600	1000 600	1000 600
TENSIONE DI TENUTA AD IMPULSO - IMPULSE WITHSTAND VOLTAGE		----	KV	8	8	8	8	8	8	8	8	8	8	8
CORRENTE D'IMPIEGO - OPERATIONAL CURRENT AC23A	I _e	415 V	A/KW	63/35	100/45	125/55	160/75	200/105	250/132	315/155	400/200	630/355	800/400	1000/500
		500 V		63/40	100/65	125/75	160/100	200/125	250/160	315/200	400/280	630/425	800/560	1000/670
		690 V		63/50	100/80	125/90	160/140	200/175	250/220	315/275	400/375	630/475	800/710	1000/1000
CORRENTE D'IMPIEGO - OPERATIONAL CURRENT AC22A	I _e	1000 V	A	63	100	125	160	200	250	315	400	630	800	1000
CORRENTE D'IMPIEGO - OPERATIONAL CURRENT DC23A	I _e	220 V	A/KW	63	100	125	160	200	250	315	400	630	800	1000
		440 V		63	100	125	160	200	250	315	400	630	800	1000
		600 V		63	100	125	160	200	250	315	400	630	800	1000
POTENZA REATTIVA - REACTIVE POWER	note (1)	380 V	KVAr	35	50	60	75	100	125	150	250	315	350	400
CORRENTE DI BREVE DURATA RATED SHORT-TIME WITHSTAND CURRENT	I _{cw}	1 sec	KA r.m.s.	4	5	8	10	10	12,5	15	18	20	25	40
POTERE DI CHIUSURA IN C.T.O C.T.O RATED SHORT-CIRCUIT MAKING CAPACITY	I _{cw}	690 V	KA peak	10	12	20	25	25	31	37	44	50	63	84
DURATA MECCANICA - MECHANICAL ENDURANCE		operazioni - operations	n°	10000	10000	8000	8000	8000	8000	8000	5000	5000	3000	3000
VITA ELETTRICA - ELECTRICAL LIFE		operazioni - operations	n°	1500	1500	1000	1000	1000	1000	1000	1000	1000	500	500
POTENZA DISSIPATA PER POLO - POWER LOSSES FOR POLE		----	W	0,8	2	3,1	5,1	8	8,2	13	20	50	50	55
PESO - WEIGHT CNS 3 pole - orizzontale - horizontal		----	Kg	6	6	6	6	6	10,1	10,5	10,5	10,9	20,7	22,9
PESO - WEIGHT CNS 4 pole - orizzontale - horizontal		----	Kg	6,8	6,8	6,8	6,8	6,8	11,3	11,9	11,9	13,1	23,7	26,7
PESO - WEIGHT CNQ 3 pole - verticale - vertical		----	Kg	5,9	5,9	5,9	5,9	5,9	9,9	10,3	10,3	10,7	20,2	22,4
PESO - WEIGHT CNQ 4 pole - verticale - vertical		----	Kg	6,7	6,7	6,7	6,7	6,7	11,1	11,7	11,7	12,9	23,2	26,2
PESO - WEIGHT DNS 3 pole - orizzontale - horizontal deviator		----	Kg	5,5	5,5	5,5	5,5	5,5	9,6	10	10	10,4	20,2	22,4
PESO - WEIGHT DNS 4 pole - orizzontale - horizontal deviator		----	Kg	6,3	6,3	6,3	6,3	6,3	10,8	11,4	11,4	12,6	23,2	26,2
PESO - WEIGHT DNQ 3 pole - verticale - vertical deviator		----	Kg	5,4	5,4	5,4	5,4	5,4	9,4	9,8	9,8	10,2	19,7	21,9
PESO - WEIGHT DNQ 4 pole - verticale - vertical deviator		----	Kg	6,2	6,2	6,2	6,2	6,2	10,6	11,2	11,2	12,4	22,7	25,7

note (1) a causa delle armoniche e delle tolleranze dei condensatori, i valori nominali devono essere ridotti del 33% - due to harmonics and tolerance of the capacitors, the rated values have been reduced by 33%

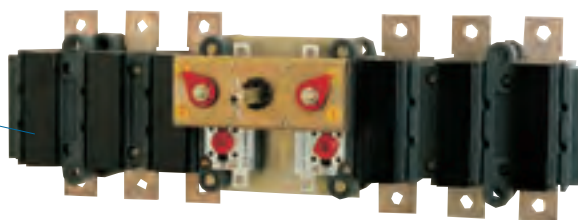

con barrette e copribarrette
 with bars and link bar covers

codici per ordini - ordering codes

CNS _v	125A	160A	200A	250A	400A	630A	630A	800A	1000A
3 pole	ECNS012532200	ECNS016032200	ECNS020032200	ECNS025032200	ECNS040032200	ECNS063032100	ECNS063032200	ECNS080032200	ECNS100032200
4 pole Note (1)	ECNS012542210	ECNS016042210	ECNS020042210	ECNS025042210	ECNS040042210	ECNS063042110	ECNS063042210	ECNS080042210	ECNS100042210
4 pole Note (2)	ECNS012542220	ECNS016042220	ECNS020042220	ECNS025042220	ECNS040042220	ECNS063042120	ECNS063042220	ECNS080042220	ECNS100042220
4 pole Note (3)	ECNS012542230	ECNS016042230	ECNS020042230	ECNS025042230	ECNS040042230	ECNS063042130	ECNS063042230	ECNS080042230	ECNS100042230
4 pole Note (4)	ECNS012542240	ECNS016042240	ECNS020042240	ECNS025042240	ECNS040042240	ECNS063042140	ECNS063042240	ECNS080042240	ECNS100042240
4 pole Note (5)	ECNS012542270	ECNS016042270	ECNS020042270	ECNS025042270	ECNS040042270	ECNS063042170	ECNS063042270	ECNS080042270	ECNS100042270

Note (1) 4.to polo addossato sezionato - 4th leaning switched pole
 Note (2) 4.to polo laterale sezionato - 4th side switched pole
 Note (3) 4.to polo addossato passante non sezionabile - 4th leaning unswitched pole

Note (4) 4.to polo laterale passante non sezionabile - 4th side unswitched pole
 Note (5) 4.to polo laterale passante sezionabile - 4th side switchable pole

Per ordinare i Deviatori (II-I) sostituire la seconda lettera C del codice con la lettera D. Esempio: ECNS012532200 diventa EDNS012532200
 To order Deviators (II-I) replace the second letter C of code with letter D. Example: ECNS012532200 becomes EDNS012532200

nota: per gli ordini in Italia sostituire con la J la E iniziale nel codice prodotto

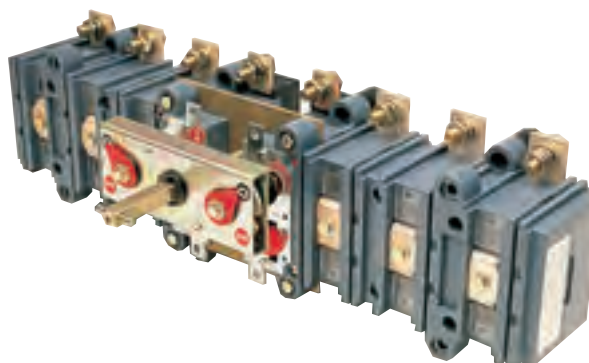

sezionamento visibile
 visible isolation

codici per ordini - ordering codes

CNS _v	125A	160A	200A	250A	400A	630A	800A	1000A
3 pole	ECNS012532000	ECNS016032000	ECNS020032000	ECNS025032000	ECNS040032000	ECNS063032000	ECNS080032000	ECNS100032000
4 pole Note (1)	ECNS012542010	ECNS016042010	ECNS020042010	ECNS025042010	ECNS040042010	ECNS063042010	ECNS080042010	ECNS100042010
4 pole Note (2)	ECNS012542020	ECNS016042020	ECNS020042020	ECNS025042020	ECNS040042020	ECNS063042020	ECNS080042020	ECNS100042020
4 pole Note (3)	ECNS012542030	ECNS016042030	ECNS020042030	ECNS025042030	ECNS040042030	ECNS063042030	ECNS080042030	ECNS100042030
4 pole Note (4)	ECNS012542040	ECNS016042040	ECNS020042040	ECNS025042040	ECNS040042040	ECNS063042040	ECNS080042040	ECNS100042040
4 pole Note (5)	ECNS012542070	ECNS016042070	ECNS020042070	ECNS025042070	ECNS040042070	ECNS063042070	ECNS080042070	ECNS100042070

Note (1) 4.to polo addossato sezionato - 4th leaning switched pole
 Note (2) 4.to polo laterale sezionato - 4th side switched pole
 Note (3) 4.to polo addossato passante non sezionabile - 4th leaning unswitched pole

Note (4) 4.to polo laterale passante non sezionabile - 4th side unswitched pole
 Note (5) 4.to polo laterale passante sezionabile - 4th side switchable pole

Per ordinare i Deviatori (II-I) sostituire la seconda lettera C del codice con la lettera D. Esempio: ECNS012532000 diventa EDNS012532000
 To order Deviators (II-I) replace the second letter C of code with letter D. Example: ECNS012532000 becomes EDNS012532000

nota: per gli ordini in Italia sostituire con la J la E iniziale nel codice prodotto

CNS 125A-1000A
 3-4 pole
 DNS 125A-1000A
 3-4 pole

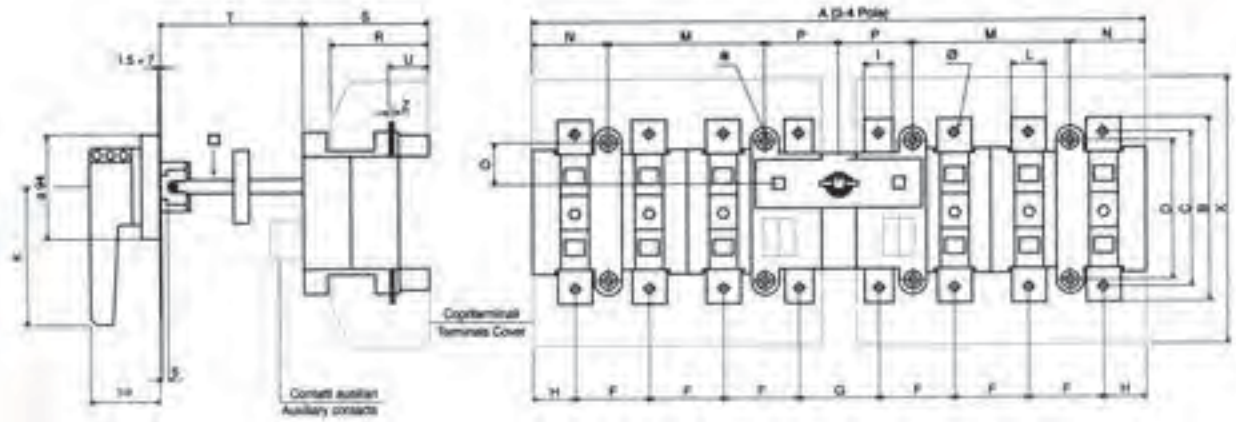

	A	B	C	D	F	G	H	I	K	L	M	N	O	P	R	S	T	U	X	Z	Ø	□	*
CNS/DNS 125A																							
CNS/DNS 160A	407	133	113	107	44	79	32	16	125	20	98	51	33	54.5	72	95	125	29	188	3	8.5	12	5.5
CNS/DNS 200A																							
CNS/DNS 250A										25													
CNS/DNS 400A	539	161	136	119	65	65	42	25	165	30	137	72	36	60.5	90	113	129	36	234	4	10.5	12	6.5
CNS/DNS 630A		187	156							35													
CNS/DNS 800A																							
CNS/DNS 1000A	721	238	200	176	87	101	49	36	165	40	174	92	64	97.5	108	130	137	48	333	6 10	12.5	12	7

caratteristiche tecniche-technical characteristics

CNP / DNP (da pagina 31 a pagina 31 - from page 31 to page 32)

CORRENTE NOMINALE A T.A. MAX 40C° RATED THERMAL CURRENT AT 40°C MAX A.T.	I _{th}	in aria libera free air	A	125	160	200	250	315	400	630	800	1000	1250	1600	1800	2000
		in cassetta box	A	125	150	160	200	300	350	630	720	910	1250	1600	1600	1800
NUMERO DEI POLI - NUMBER OF POLES		----	----	3-4-6-8	3-4-6-8	3-4-6-8	3-4-6-8	3-4-6-8	3-4-6-8	3-4-6-8	3-4-6-8	3-4-6-8	3-4-6-8	3-4-6-8	3-4-6-8	3-4-6-8
TENSIONE D'ISOLAMENTO - RATED VOLTAGE OF ISOLATION	U _i	c.a./a.c. c.c./d.c.	V	1000	1000	1000	1000	1000	1000	1000	1000	1000	1000	1000	1000	1000
TENSIONE DI TENUTA AD IMPULSO - IMPULSE WITHSTAND VOLTAGE		----	KV	8	8	8	8	8	8	8	8	8	8	8	8	8
CORRENTE D'IMPIEGO - OPERATIONAL CURRENT	I _e	500 V	A	125	160	200	250	315	400	630	800	1000	1250	1600	1800	2000
CORRENTE D'IMPIEGO - OPERATIONAL CURRENT	I _e	415 V	A	125	160	200	250	315	400	630	800	1000	1250	1600	1600	1600
CORRENTE D'IMPIEGO - OPERATIONAL CURRENT	I _e	415 V	A	125	160	200	250	315	400	630	630	800	-	-	-	-
POTENZA REATTIVA - REACTIVE POWER ^{note (1)}		380 V	KVAr	6075	100	125	150	200	280	300	320	400	500	-	-	-
CORRENTE DI BREVE DURATA RATED SHORT-TIME WITHSTAND CURRENT	I _{cw}	1 sec r.m.s.	KA	8	10	10	12,5	15	21	32	36	40	50	55	55	60
POTERE DI CHIUSURA IN C.TO C.TO RATED SHORT-CIRCUIT MAKING CAPACITY	I _{cm}	415 V peak	KA	20	25	25	31	37	45	67	76	84	105	121	121	132
DURATA MECCANICA - MECHANICAL ENDURANCE		operazioni n° operations	8000	8000	8000	8000	8000	5000	5000	3000	3000	3000	3000	3000	3000	3000
VITA ELETTRICA - ELECTRICAL LIFE		operazioni n° operations	1000	1000	1000	1000	1000	1000	1000	500	500	500	500	500	500	500
TEMPI DI COMMUTAZIONE I-0-II O II-0-I CHANGE-OVER TIME I-0-II O II-0-I		---- (sec)	12	12	12	12	12	12	12	12	12	12	12	12	12	12
POTENZA DISSIPATA PER POLO - POWER LOSSES FOR POLE		---- W	3,1	5,1	8	3,3	8,8	8,8	23	25	34	40	63	65	80	80
PESO - WEIGHT CNP 3 pole horizontal		---- Kg	-	-	-	6,8	7,1	7,1	11,1	13,5	23	26,7	28,7	36,7	36,7	36,7
PESO - WEIGHT CNP 4 pole horizontal		---- Kg	-	-	-	7,6	8,8	8,8	12,9	15,5	25	30,7	35,7	45,7	45,7	45,7
PESO - WEIGHT DNP 3 pole horizontal		---- Kg	-	-	-	6,4	6,6	6,6	10,6	13	22,3	26	28	36	36	36
PESO - WEIGHT DNP 4 pole horizontal		---- Kg	-	-	-	7,2	8,3	8,3	12,4	15	24,3	30	35	45	45	45

note(1) a causa delle armoniche e delle tolleranze dei condensatori, i valori nominali devono essere ridotti del 33%
due to harmonics and tolerance of the capacitors, the rated values have been reduced by 33%

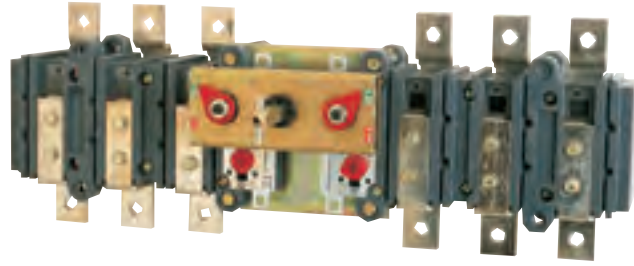

codici per ordini - ordering codes

CNP \H	250A	400A	630A	800A	1000A	1250A	1600A	1800A	2000A
3 pole	ECNP025033000	ECNP040033000	ECNP063033000	ECNP080033000	ECNP100033000	ECNP125033000	ECNP160033000	ECNP180033000	ECNP200033000
4 pole Note (1)	ECNP025043010		ECNP063043010						
4 pole Note (2)	ECNP025043020	ECNP040043020	ECNP063043020	ECNP080043020	ECNP100043020	ECNP125043020	ECNP160043020	ECNP180043020	ECNP200043020
4 pole Note (3)	ECNP025043030		ECNP063043030						
4 pole Note (4)	ECNP025043040	ECNP040043040	ECNP063043040	ECNP080043040	ECNP100043040	ECNP125043040	ECNP160043040	ECNP180043040	ECNP200043040
4 pole Note (5)	ECNP025043070	ECNP040043070	ECNP063043070	ECNP080043070	ECNP100043070	ECNP125043070	ECNP160043070	ECNP180043070	ECNP200043070

- Note (1) 4.to polo addossato sezionato - 4th leaning switched pole
 Note (2) 4.to polo laterale sezionato - 4th side switched pole
 Note (3) 4.to polo addossato passante non sezionabile - 4th leaning unswitched pole

- Note (4) 4.to polo laterale passante non sezionabile - 4th side unswitched pole
 Note (5) 4.to polo laterale passante sezionabile - 4th side switchable pole

Per ordinare i Deviatori (II-I) sostituire la seconda lettera C del codice con la lettera D. Esempio: ECNP012530000 diventa EDNP012530000
 To order Deviators (II-I) replace the second letter C of code with letter D. Example: ECNP012530000 becomes EDNP012530000

nota: per gli ordini in Italia sostituire con la J la E iniziale nel codice prodotto

CNP 250A:1000A 3-4 pole
 DNP 250A:1000A 3-4 pole

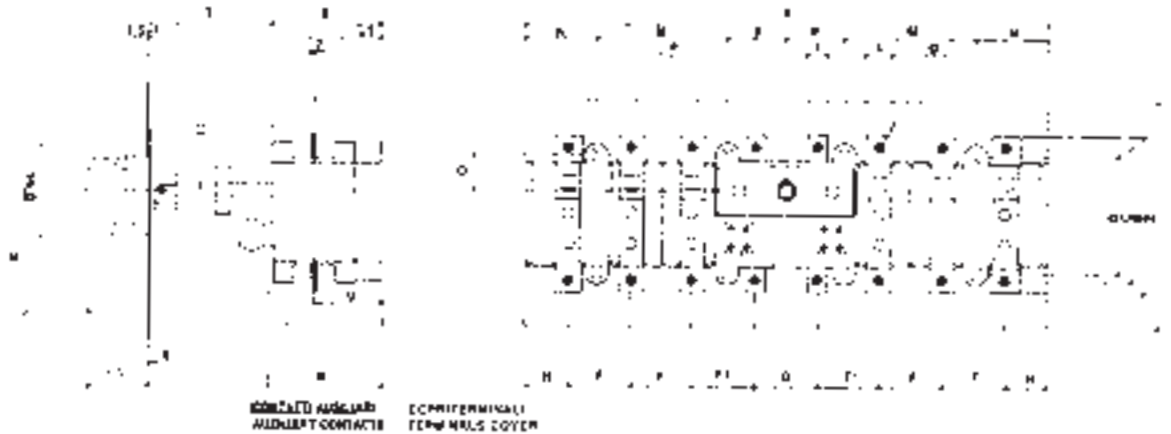

	A	A	B	C	D	F	F ₁	G	G	H	I	L	M	N	O	P	P	R	S	T	U	U ₁	W	K	X	Z	□	∅	*
	3 pole	4 pole						3 pole	4 pole							3 pole	4 pole												
CNP-DNP 250A	407	443	153	128	107	44	82	167	46	28	25	25	98	51	33	54,5	72,5	98	95	130	57	45	94	125	188	4	12	10,5	5,5
CNP-DNP 400A																										5			
CNP-DNP 630A	539	645	200	167	119	65	109	195	82	42	30	30	137	72	36	60,5	113,5	115	113	128	70	50	94	165	235	5	12	12,5	6,5
CNP-DNP 800A																										10			
CNP-DNP 1000A																										--			

per le tabelle dimensionali e i disegni del CNP 1250A:2000A vedi pag. 33
 see page 33 for dimensional tables and drawings of CNP 1250A:2000A

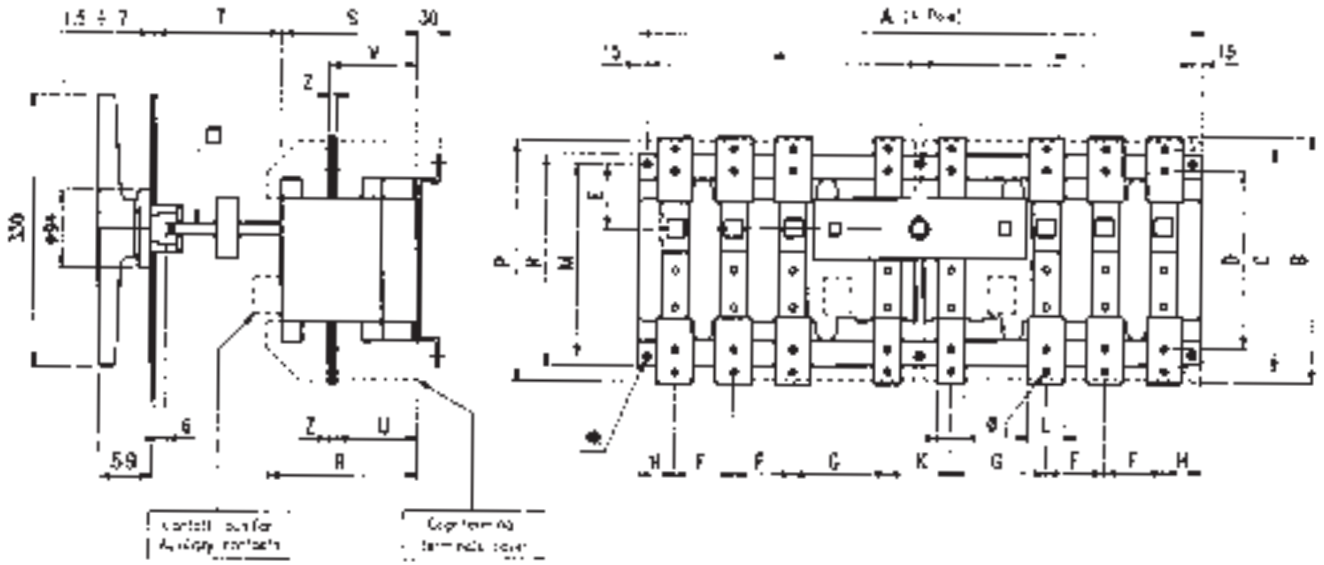

CNP 1250A:2000A 3-4 pole
 DNP 1250A:1000A 3-4 pole

	A	A	B	C	D	E	F	G	H	I	K	K	L	M	N	P	R	S	T	U	V	Z	□	∅	*
	3 pole	4 pole									3 pole	4 pole													
CNP-DNP 1250A	721	773	352	316	266	96	87	130	49	40	275	67	40	240	270	334	150	130	137	80	92	10	12	12,5	7
CNP-DNP 1600A																						12			
CNP-DNP 1800A																						20			
CNP-DNP 2000A																						20			

CORRENTE NOMINALE A. T. A. MAX 40°C RATED THERMAL CURRENT AT 40°C MAX A. T.	I _{th}	in aria libera free air	A	63	100	125	160	200	250	315	400	630	800
		in cassetta box	A	63	100	110	150	160	200	300	340	550	630
NUMERO DEI POLI - NUMBER OF POLES		----	----	3-4	3-4	3-4	3-4	3-4	3-4	3-4	3-4	3-4	3-4
TENSIONE D'ISOLAMENTO - RATED VOLTAGE OF ISOLATION	U _i	c.a./a.c. c.c./d.c.	V	1000 600	1000 600	1000 600	1000 600	1000 600	1000 600	1000 600	1000 600	1000 600	1000 600
TENSIONE DI TENUTA AD IMPULSO - IMPULSE WITHSTAND VOLTAGE		----	KV	8	8	8	8	8	8	8	8	8	8
CORRENTE D'IMPIEGO - OPERATIONAL CURRENT AC23A	I _e	415 V		63/35	100/45	125/55	160/75	200/105	250/132	315/155	400/200	630/355	800/400
		500 V	A/KW	63/40	100/65	125/75	160/100	200/125	250/160	315/200	400/280	630/425	800/560
		690 V		63/50	100/80	125/90	160/140	200/175	250/220	315/275	400/375	630/560	800/710
CORRENTE D'IMPIEGO - OPERATIONAL CURRENT AC22A	I _e	1000 V	A	63	100	125	160	200	250	315	400	630	800
CORRENTE D'IMPIEGO - OPERATIONAL CURRENT DC23A	I _e	220 V		63	100	125	160	200	250	315	400	630	800
note (G) page 0		440 V	A	63	100	125	160	200	250	315	400	630	800
POTENZA REATTIVA - REACTIVE POWER	note (1)	600 V	KVAr	35	50	60	75	100	125	150	250	315	350
POTERE DI CHIUSURA CONDIZIONATO DA FUSIBILE RATED SHORT-CIRCUIT MAKING CAPACITY	I _{cm}	380 V	KA peak	100	100	100	100	100	100	100	100	100	100
DURATA MECCANICA - MECHANICAL ENDURANCE		690 V	n° peak	10000	10000	8000	8000	8000	8000	8000	5000	5000	3000
VITA ELETTRICA - ELECTRICAL LIFE		operazioni - operations	n°	1500	1500	1000	1000	1000	1000	1000	1000	1000	500
FUSIBILI TIPO - FUSE TYPE		operazioni - operations	----	00	00	00 & 0	00 & 0	----	1-2	----	1-2	3	----
		DIN 43620		22x58	22x58	22x58	22x58	----	----	----	----	----	----
		NFC 63210		A2-A3	A2-A3	A4	A4	B1-B2	B1-B3	B2-B3	B1-B4	C1-C2	C1-C3
		BS 88											
POTENZA DISSIPATA PER POLO - POWER LOSSES FOR POLE		W	----	1,2	3,1	4,8	6,6	11	12	19	28	40	63
PESO - WEIGHT CNF 3 pole • orizzontale - horizontal		DIN 43620	Kg	6,2	6,2	6,2	6,2	6,2	10,8	11,3	11,3	20,9	----
PESO - WEIGHT CNF 4 pole • orizzontale - horizontal		DIN 43620	Kg	6,8	6,8	6,8	6,8	6,8	12,3	12,5	12,5	24,3	----
PESO - WEIGHT CNF 3 pole • orizzontale - horizontal		NFC 63210	Kg	6,2	6,2	6,2	6,2	6,2	6,2	6,2	6,2	6,2	6,2
PESO - WEIGHT CNF 4 pole • orizzontale - horizontal		NFC 63210	Kg	6,8	6,8	6,8	6,8	6,8	6,8	6,8	6,8	6,8	6,8
PESO - WEIGHT CNF 3 pole • orizzontale - horizontal		BS 88	Kg	6,4	6,4	6,4	6,4	6,4	11,1	11,3	11,3	22,9	26,1
PESO - WEIGHT CNF 4 pole • orizzontale - horizontal		BS 88	Kg	7,2	7,2	7,2	7,2	7,2	12,7	12,9	12,9	25,9	29,9
PESO - WEIGHT DNF 3 pole • orizzontale - horizontal deviator		DIN 43620	Kg	5,7	5,7	5,7	5,7	5,7	10,3	10,8	10,8	20,4	----
PESO - WEIGHT DNF 4 pole • orizzontale - horizontal deviator		DIN 43620	Kg	6,3	6,3	6,3	6,3	6,3	11,8	12	12	23,8	----
PESO - WEIGHT DNF 3 pole • orizzontale - horizontal deviator		NFC 63210	Kg	5,7	5,7	5,7	5,7	5,7	5,7	5,7	5,7	5,7	5,7
PESO - WEIGHT DNF 4 pole • orizzontale - horizontal deviator		NFC 63210	Kg	6,3	6,3	6,3	6,3	6,3	6,3	6,3	6,3	6,3	6,3
PESO - WEIGHT DNF 3 pole • orizzontale - horizontal deviator		BS 88	Kg	5,9	5,9	5,9	5,9	5,9	10,6	10,8	10,8	22,4	25,6
PESO - WEIGHT DNF 4 pole • orizzontale - horizontal deviator		BS 88	Kg	6,7	6,7	6,7	6,7	6,7	12,2	12,4	12,4	25,4	29,4

note (1) a causa delle armoniche e delle tolleranze dei condensatori, i valori nominali devono essere ridotti del 33% - due to harmonics and tolerance of the capacitors, the rated values have been reduced by 33%

fusibili esclusi
dalla fornitura
fuses out of supply



fusibili Din
Din fuses

codici per ordini - ordering codes

CNF \ D	125A NH0	125A NH00	160A NH0	160A NH00	250A	400A	630A
3 pole	ECNF01253010O	ECNF01253020O	ECNF01603010O	ECNF01603020O	ECNF02503030O	ECNF04003040O	ECNF06303050O
4 pole Note (1)	ECNF01254011O	ECNF01254021O	ECNF01604011O	ECNF01604021O	ECNF02504031O	ECNF04004041O	ECNF06304051O
4 pole Note (2)	ECNF01254012O	ECNF01254022O	ECNF01604012O	ECNF01604022O	ECNF02504032O	ECNF04004042O	ECNF06304052O
4 pole Note (3)	ECNF01254013O	ECNF01254023O	ECNF01604013O	ECNF01604023O	ECNF02504033O	ECNF04004043O	ECNF06304053O
4 pole Note (4)	ECNF01254014O	ECNF01254024O	ECNF01604014O	ECNF01604024O	ECNF02504034O	ECNF04004044O	ECNF06304054O
4 pole Note (5)	ECNF01254017O	ECNF01254027O	ECNF01604017O	ECNF01604027O	ECNF02504037O	ECNF04004047O	ECNF06304057O

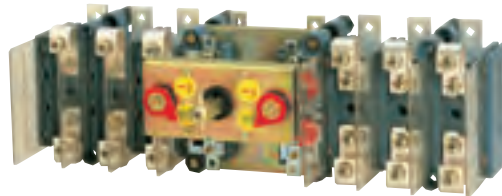

fusibili BS
BS fuses

codici per ordini - ordering codes

CNF \ B	125A	160A	200A	250A	315A	400A	630A	800A
3 pole	ECNF01253110O	ECNF01603130O	ECNF02003140O	ECNF02503140O	ECNF03153150O	ECNF04003150O	ECNF06303170O	ECNF08003180O
4 pole Note (1)	ECNF01254111O	ECNF01604131O	ECNF02004141O	ECNF02504141O	ECNF03154151O	ECNF04004151O	ECNF06304171O	ECNF08004181O
4 pole Note (2)	ECNF01254112O	ECNF01604132O	ECNF02004142O	ECNF02504142O	ECNF03154152O	ECNF04004152O	ECNF06304172O	ECNF08004181O
4 pole Note (3)	ECNF01254113O	ECNF01604133O	ECNF02004143O	ECNF02504143O	ECNF03154153O	ECNF04004153O	ECNF06304173O	ECNF08004183O
4 pole Note (4)	ECNF01254114O	ECNF01604134O	ECNF02004144O	ECNF02504144O	ECNF03154154O	ECNF04004154O	ECNF06304174O	ECNF08004184O
4 pole Note (5)	ECNF01254117O	ECNF01604137O	ECNF02004147O	ECNF02504147O	ECNF03154157O	ECNF04004157O	ECNF06304177O	ECNF08004187O

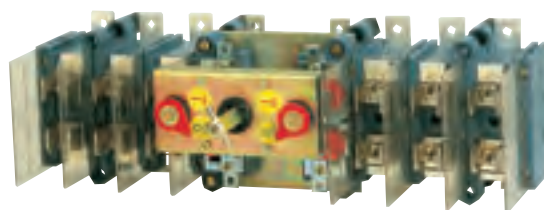

fusibili NFC
NFC fuses

codici per ordini - ordering codes

CNF \ N	125A
3 pole	ECNF01253070O
4 pole Note (1)	ECNF01254071O
4 pole Note (2)	ECNF01254072O
4 pole Note (3)	ECNF01254073O
4 pole Note (4)	ECNF01254074O
4 pole Note (5)	ECNF01254077O

- Note (1) 4.to polo addossato sezionato - 4th leaning switched pole
- Note (2) 4.to polo laterale sezionato - 4th side switched pole
- Note (3) 4.to polo addossato passante non sezionabile - 4th leaning unswitched pole
- Note (4) 4.to polo laterale passante non sezionabile - 4th side unswitched pole
- Note (5) 4.to polo laterale passante sezionabile - 4th side switchable pole

Per ordinare i Deviatori (II-I) sostituire la seconda lettera C del codice con la lettera D. Esempio: ECNF01253010O diventa EDNF01253010O
To order Deviators (II-I) replace the second letter C of code with letter D. Example: ECNF01253010O becomes EDNF01253010O

nota: per gli ordini in Italia sostituire con la J la E iniziale nel codice prodotto

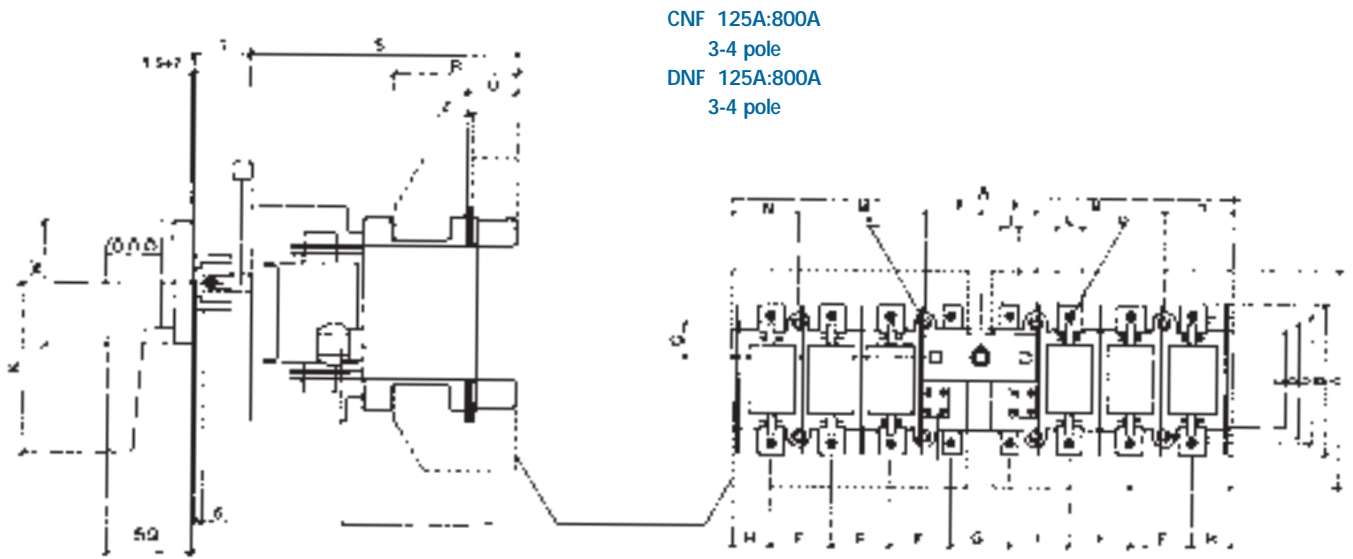

CNF 125A:800A
 3-4 pole
 DNF 125A:800A
 3-4 pole

3 poli o 4to polo addossato - 3 pole or 4th leaning pole

	A	B	C	D	F	G	H	I	J	K	L	M	N	O	P	R	S	T	U	X	Z	∅	□	*
CNF-DNF 125A																		68 (CNF) 40 (DNF)	29	188	3	8,5	12 (CNF) 10 (DNF)	5,5
CNF-DNF 160A	407	133	113	107	44	79	32	20	...	125	20	98	51	33	54	72	150							
CNF-DNF 200A																								
CNF-DNF 250A								25			25							40 (CNF) 37 (DNF)					12 (CNF) 10 (DNF)	6,5
CNF-D NF 315A	539	161	136	119	65	65	42	25	...	125	30	137	72	36	60	90	196		36	234	4	10,5		
CNF-DNF 400A								35			35													
CNF-DNF 630A	721	238	200	176	87	101	49	36	...	165	40	174	92	64	98	108	230	28 (CNF) 40 (DNF)	48	333	6 10	12,5	12 (CNF) 10 (DNF)	7
CNF-DNF 800A																								

4to polo laterale - 4th side pole

	A	B	C	D	F	G	H	I	J	K	L	M	N	O	P	R	S	T	U	X	Z	∅	□	*
CNF-DNF 125A																		68 (CNF) 40 (DNF)	29	188	3	8,5	12 (CNF) 10 (DNF)	5,5
CNF-DNF 160A	444	133	113	107	44	40	32	20	82	125	20	98	51	33	67	72	150							
CNF-DNF 200A																								
CNF-DNF 250A								25			25							40 (CNF) 37 (DNF)					12 (CNF) 10 (DNF)	6,5
CNF-D NF 315A	643	161	136	119	65	81	42	25	109	125	30	137	72	36	100	90	191		36	234	4	10,5		
CNF-DNF 400A								35			35													
CNF-DNF 630A	769	238	200	176	87	63	49	36	130	165	40	174	92	64	100	108	230	28 (CNF) 40 (DNF)	48	333	6 10	12,5	12 (CNF) 10 (DNF)	7
CNF-DNF 800A																								

ACCESSORI - ACCESSORIES

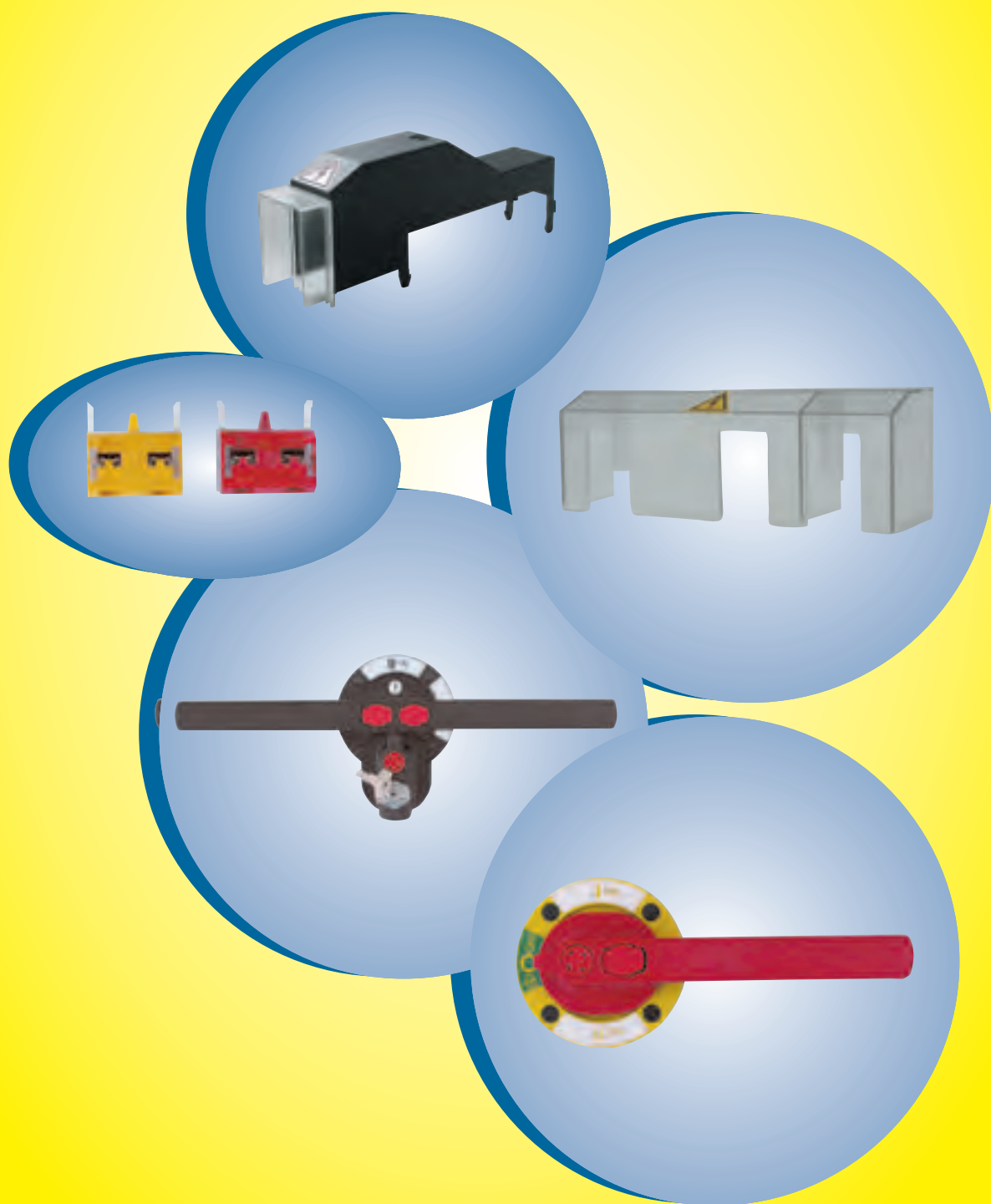

MANIGLIE RINVIATE - per commutatori manuali (di serie) e commutatori by pass (di serie)
per commutatori motorizzati e commutatori by pass motorizzati (nota bene: chiedere all'ufficio tecnico)

HANDLES FOR DOOR - for change-over switches (standard) and by-pass change-over switches (standard)
for motor driven change-over switches and motor driven by-pass change-over switches (contact our technical department)

maniglia corta rinvia pos. II-0-I
short handle for door pos. II-0-I



nera - black



rossa - red

adatta per - suitable for

CKS 125A : 630A 3-4 pole
CKF 125A : 630A 3-4 pole
CNS 63A : 400A 3-4 pole
CNS 63A : 400A 6-8 pole
CNP 250A : 800A 3-4 pole
CNQ 125A : 400A 3-4 pole
CNF 125A : 400A 3-4 pole
BPV 125A : 200A 3-4 pole

Code	con blocco porta (di serie) with door lock (standard)	con blocco a chiave with key lock	con sblocco porta with door interlock override	con blocco a chiave e sblocco porta with key lock and door interlock override
nera - black	EXMN11200003A	EXMN11201003A	EXMN11200103A	EXMN11201103A
rossa - red	EXMN13200003A	EXMN13201003A	EXMN13200103A	EXMN13201103A

maniglia lunga rinvia pos. II-0-I
long handle for door pos. II-0-I



nera - black



rossa - red

adatta per - suitable for

CKS 800A : 1250A 3-4 pole
CKS 125A : 630A 6-8 pole
CKF 800A : 1250A 3-4 pole
CNF 630A : 800A 3-4 pole
CNS 630A : 1000A 3-4 pole
BPV 250A : 1000A 3-4 pole
CNS 630A : 1000A 6-8 pole
CNP 1000A : 2000A 3-4 pole
CNP 250A : 800A 6-8 pole
CNQ 125A : 400A 6-8 pole

Code	con blocco porta (di serie) with door lock (standard)	con blocco a chiave with key lock	con sblocco porta with door interlock override	con blocco a chiave e sblocco porta with key lock and door interlock override
nera - black	EXMN21200003A	EXMN21201003A	EXMN21200103A	EXMN21201103A
rossa - red	EXMN23200003A	EXMN23201003A	EXMN23200103A	EXMN23201103A

maniglia doppia rinvia pos. II-0-I
double handle for door pos. II-0-I



nera - black



rossa - red

Code	senza blocco lucchetto (di serie) without padlock facility (standard)	con blocco lucchetto with padlock facility	con sblocco porta with door interlock override
nera - black	EXMN41200003A	EXMN31200003A	EXMN31200103A
rossa - red	EXMN43200003A	EXMN33200003A	EXMN33200103A

adatta per - suitable for

CKS 800A : 1250A 6-8 pole
CNP 1000A : 2000A 6-8 pole
CNP 2500A : 6300A 3-4 pole
CNP 2500A : 6300A 6-8 pole
BPV 1250A : 2000A 3-4 pole



nera - black



rossa - red

Code	con blocco a chiave with key lock	con blocco a chiave e sblocco porta with key lock and door interlock override
nera - black	EXMN31201003A	EXMN31201103A
rossa - red	EXMN33201003A	EXMN33201103A

MANIGLIE RINVIATE - per commutatori manuali (di serie) e commutatori by pass (di serie)
per commutatori motorizzati e commutatori by pass (nota bene: chiedere all'ufficio tecnico)

DIRECT HANDLES - for change-over switches (standard) and by-pass change-over switches (standard)
for motor driven change-over switches and motor-driven by-pass change-over switches (contact our technical department)

maniglia corta rinvia pos. II-I
short handle for door pos. II-I



nera - black



rossa - red

adatta per - suitable for
DNS 63A : 200A 6-8 pole
DKF 125A : 630A 3-4 pole
DNP 250A : 400A 3-4 pole
DNQ 125A : 200A 3-4 pole
DNF 125A : 200A 3-4 pole
BPD 125A : 200A 3-4 pole
DKS 125A : 630A 3-4 pole
DNS 63A : 200A 3-4 pole

Code	con blocco porta (di serie) with door lock (standard)	con blocco a chiave with key lock	con sblocco porta with door interlock override	con blocco a chiave e sblocco porta with key lock and door interlock override
nera - black	EXMN11201005A	EXMN11201005A	EXMN11200105A	EXMN11201105A
rossa - red	EXMN13200005A	EXMN13201005A	EXMN13200105A	EXMN13201105A

maniglia lunga rinvia pos. II-I
long handle for door pos. II-I



nera - black



rossa - red

adatta per - suitable for
DKS 800A : 1250A 3-4 pole
DNS 250A : 1000A 3-4 pole
DNS 250A : 1000A 6-8 pole
DNP 630A : 1000A 3-4 pole
DNP 250A : 400A 6-8 pole
DKS 125A : 630A 6-8 pole
DNQ 125A : 200A 6-8 pole
DNQ 250A : 400A 3-4 pole
DNQ 250A : 400A 6-8 pole
DNF 250A : 800A 3-4 pole
BPD 250A : 1000A 3-4 pole
DKF 800A : 1250A 3-4 pole

Code	con blocco porta (di serie) with door lock (standard)	con blocco a chiave with key lock	con sblocco porta with door interlock override	con blocco a chiave e sblocco porta with key lock and door interlock override
nera - black	EXMN21200005A	EXMN21201005A	EXMN21200105A	EXMN21201105A
rossa - red	EXMN23200005A	EXMN23201005A	EXMN23200105A	EXMN23201105A

maniglia doppia rinvia pos. II-I
double handle for door pos. II-I



nera - black



rossa - red

Code	senza blocco lucchetto (di serie) without padlock facility (standard)	con blocco lucchetto with padlock facility	con sblocco porta with door interlock override
nera - black	EXMN41200005A	EXMN31200005A	EXMN31200105A
rossa - red	EXMN43200005A	EXMN33200005A	EXMN33200105A

adatta per - suitable for
DKS 800A : 1250A 6-8 pole
DNP 630A : 1000A 6-8 pole
DNP 1250A : 6300A 3-4 pole
DNP 1250A : 6300A 6-8 pole
BPD 1250A : 2000A 3-4 pole



nera - black



rossa - red

Code	con blocco a chiave with key lock	con blocco a chiave e sblocco porta with key lock and door interlock override
nera - black	EXMN31201005A	EXMN31201105A
rossa - red	EXMN33201005A	EXMN33201105A

MANIGLIE DIRETTE - per tutti i commutatori motorizzati (di serie)
per tutti i commutatori manuali (su richiesta)

DIRECT HANDLES - for all motor driven change-over switches (standard)
for all manual change-over switches (upon request)

maniglia corta diretta
direct short handle



nera - black



rossa - red

Code	(per albero \varnothing 10) (for shaft \varnothing 10)	adatta per - suitable for
nera - black	EXMN11240000A	CKS 125A : 630A 3-4 pole
rossa - red	EXMN13240000A	BPD 125A : 200A 3-4 pole
		DKS 125A : 630A 3-4 pole
		DNF 125A : 200A 3-4 pole
		DNS 63A : 200A 3-4 pole
		CKF 125A : 630A 3-4 pole
		DNS 63A : 200A 6-8 pole
		DKF 125A : 630A 3-4 pole
		DNP 250A : 400A 3-4 pole
		DNQ 125A : 200A 3-4 pole

Code	(per albero \varnothing 12) (for shaft \varnothing 12)	adatta per - suitable for
nera - black	EXMN11220000A	CNS 63A : 400A 3-4 pole
rossa - red	EXMN13220000A	CNS 63A : 400A 6-8 pole
		CNP 250A : 800A 3-4 pole
		CNQ 125A : 400A 3-4 pole
		CNF 125A : 400A 3-4 pole
		BPV 125A : 200A 3-4 pole

maniglia lunga diretta
direct long handle



nera - black



rossa - red

Code	(per albero \varnothing 10) (for shaft \varnothing 10)	adatta per - suitable for
nera - black	EXMN21240000A	CKS 125A : 630A 6-8 pole
rossa - red	EXMN23240000A	DKS 125A : 630A 6-8 pole
		DNP 250A : 400A 6-8 pole
		DNQ 125A : 200A 6-8 pole

Code	(per albero \varnothing 12) (for shaft \varnothing 12)	adatta per - suitable for
nera - black	EXMN21220000A	CKS 800A : 1250A 3-4 pole
rossa - red	EXMN23220000A	DKS 800A : 1250A 3-4 pole
		CKF 800A : 1250A 3-4 pole
		DKF 800A : 1250A 3-4 pole
		CNP 250A : 800A 6-8 pole
		CNP 1000A : 2000A 3-4 pole
		DNP 630A : 1000A 3-4 pole
		CNS 630A : 1000A 3-4 pole
		DNS 250A : 1000A 3-4 pole
		CNS 630A : 1000A 6-8 pole
		DNS 250A : 1000A 6-8 pole
		CNF 630A : 800A 3-4 pole
		DNF 250A : 800A 3-4 pole
		DNQ 250A : 400A 3-4 pole
		CNQ 125A : 400A 6-8 pole
		DNQ 250A : 400A 6-8 pole
		BPD 250A : 1000A 3-4 pole
		BPV 250A : 1000A 3-4 pole

maniglia doppia diretta
direct double handle



nera - black



rossa - red

Code	(per albero \varnothing 12) (for shaft \varnothing 12)
nera - black	EXMN31220000A
rossa - red	EXMN33220000A

adatta per - suitable for
CKS 800A : 1250A 6-8 pole
DNP 1250A : 6300A 6-8 pole
DKS 800A : 1250A 6-8 pole
BPV 1250A : 2000A 3-4 pole
CNP 1000A : 2000A 6-8 pole
BPD 1250A : 2000A 3-4 pole
CNP 2500A : 6300A 3-4 pole
CNP 2500A : 6300A 6-8 pole
DNP 630A : 1000A 6-8 pole
DNP 1250A : 6300A 3-4 pole

maniglia corta diretta con targa avvertenze
direct short handle with warning plate



nera - black



rossa - red

adatta per - suitable for

CKM 125A : 630A 3-4 pole
CMF 125A : 630A 3-4 pole
DKM 125A : 630A 3-4 pole
DMF 125A : 630A 3-4 pole
DMV 125A : 200A 3-4 pole
DMV 250A short 3-4 pole
BPM 125A : 200A 3-4 pole
BDM 125A : 200A 3-4 pole

adatta per - suitable for

CMV 125A : 200A 3-4 pole
CMV 250A short 3-4 pole

Code	(per albero \varnothing 10) (for shaft \varnothing 10)
nera - black	EXMN11240000T
rossa - red	EXMN13240000T

Code	(per albero \varnothing 12) (for shaft \varnothing 12)
nera - black	EXMN11220000T
rossa - red	EXMN13220000T

maniglia lunga diretta con targa avvertenze
direct long handle with warning plate



nera - black



rossa - red

adatta per - suitable for

CKM 125A : 630A 6-8 pole
DKM 125A : 630A 6-8 pole
DMV 125A : 200A 6-8 pole
DMV 250A short 6-8 pole

adatta per - suitable for

CKM 800A : 1250A 3-4 pole
DMV 250A medium 3-4 pole
DKM 800A : 1250A 3-4 pole
DMV 315A : 2000A 3-4 pole
CMV 125A : 200A 6-8 pole
BPM 250A : 2000A 3-4 pole
CMV 250A short 6-8 pole
BDM 250A : 2000A 3-4 pole
CMV 250A medium 3-4 pole
CMF 800A : 1250A 3-4 pole
CMV 315A : 2000A 3-4 pole
DMF 800A : 1250A 3-4 pole

Code	(per albero \varnothing 10) (for shaft \varnothing 10)
nera - black	EXMN21240000T
rossa - red	EXMN23240000T

Code	(per albero \varnothing 12) (for shaft \varnothing 12)
nera - black	EXMN21220000T
rossa - red	EXMN23220000T

maniglia doppia diretta con targa avvertenze
direct double handle with warning plate



nera - black



rossa - red

adatta per - suitable for

CKM 800A : 1250A 6-8 pole
DKM 800A : 1250A 6-8 pole
DMV 315A : 2000A 6-8 pole
DMV 2500A : 6300A 3-4 pole
CMV 315A : 2000A 6-8 pole
DMV 2500A : 6300A 6-8 pole
CMV 2500A : 6300A 3-4 pole
CMV 2500A : 6300A 6-8 pole
CMV 250A medium 6-8 pole
DMV 250A medium 6-8 pole

Code	(per albero \varnothing 12) - (for shaft \varnothing 12)
nera - black	EXMN31220000T
rossa - red	EXMN33220000T

dispositivo di sblocco porta
door interlock override

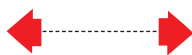

Code	EXNDS
------	-------

Applicabile a tutte le maniglie rinviate, si attiva dall'esterno del pannello. Permette l'apertura del portello in posizione di I-ON.

Applicable to all the handles for door. It must be activated from outside the panel. It allows the opening of the door in the I-ON position.

anello per ribassare le maniglie rinviate
ring to lower handles for door



anello - ring

Code **EXNDMB**

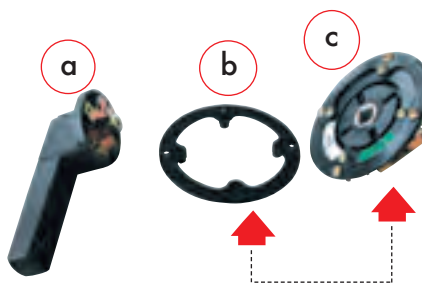

- a Impugnatura
- b Anello
- c Mostrina con impugnatura e anello

- a Handle
- b Ring to lower the handle
- c Ring with position indication



maniglia con anello - handle with ring

anello per abbassare le maniglie rinviate
ring to lower handles for door

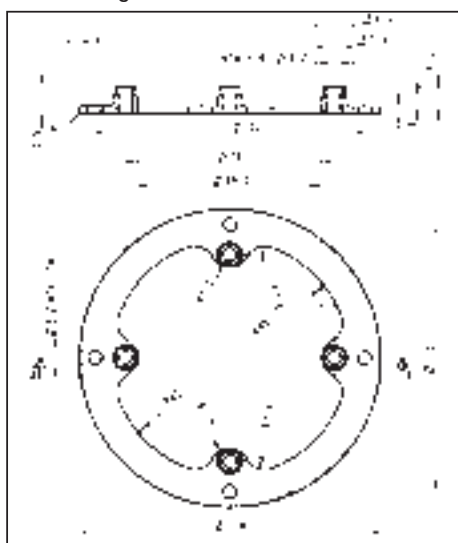

dima di foratura per maniglia bassa
drilling template for low handle

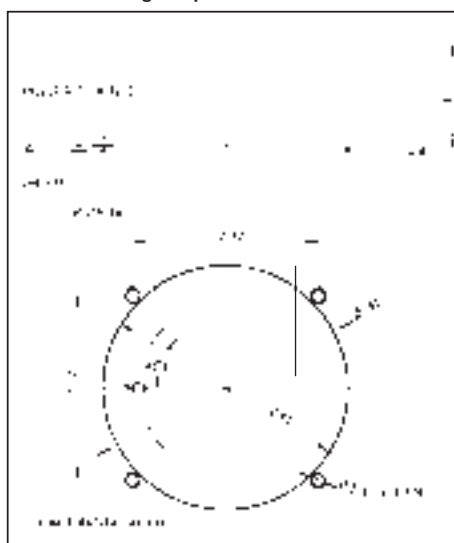

per ordinare la maniglia già completa di anello utilizzare il codice della maniglia rinviate (vedi pagine 28-29) sostituendo la lettera finale **A** del codice con la lettera **R**
Esempio: EXMN11200003**A** diventa EXMN11200003**R**.

to order handle complete with ring replace the letter **A** of handle for door ordering code (pages 28-29) with the letter **R**

Example: EXMN11200003**A** becomes EXMN11200003**R**

dime di foratura per maniglia rinviate
drilling template for handles for door

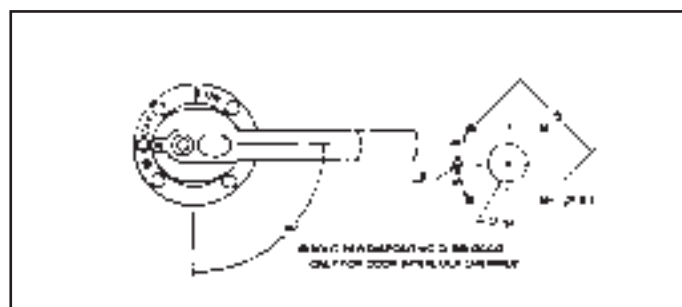
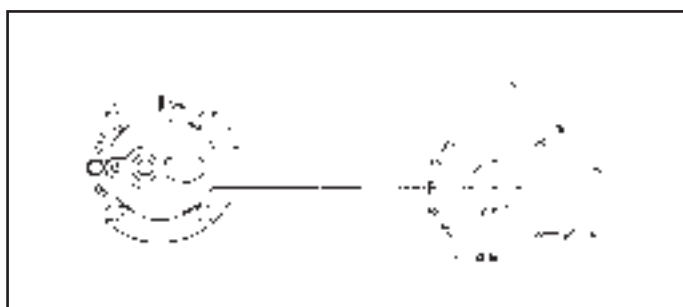

blocco a chiave
key lock



Code

EXNBC

per maniglia singola
for single handle

il blocco delle maniglie può essere tenuto in posizione di 0 - OFF e I - ON o in entrambe le posizioni
the lock of the handles can be locked in either O - OFF or I - ON position or in both positions

note: per l'uso con maniglia doppia chiedere all'ufficio tecnico
note: for double handle contact our technical department
vedi maniglie codici pg 28-29 - see handle codes page 28-29

EXMN31201003A | EXMN31201103A | EXMN33201003A | EXMN33201103A

EXMN31201005A | EXMN31201105A | EXMN33201005A | EXMN33201105A

guarnizione in gomma
handle sealing

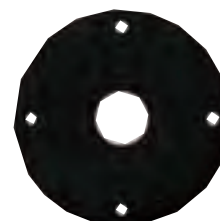

per maniglie IP 65 for IP 65 handles

Code

EXG 12

prolunga d'albero con giunzione
shaft extension with junction



Lunghezza Length 180 mm	Lunghezza Length 240 mm	Lunghezza Length 280 mm
EXT120180	EXT120240	EXT120280

Code

giunzione per prolunga
junction for shaft extension



Code

EXM12

adatta per
suitable for

CKS 800A:1250A
DKS 800A:1250A
CNS 125A:1000A
DNS 250A:1000A
CNP 250A:4000A
DNP 630A:4000A
CNQ 125A: 400A
DNQ 250A: 400A
CNF 125A: 800A
DNF 250A: 800A
BPV 125A:2000A
BPD 250A:2000A
CKF 800A:1250A
DKF 800A:1250A

prolunga d'albero con giunzione
shaft extension with junction



Lunghezza Length 180 mm	Lunghezza Length 240 mm	Lunghezza Length 280 mm
EXT100180	EXT100240	EXT100280

Code

giunzione per prolunga
junction for shaft extension



Code

EXM10

adatta per
suitable for

CKS 125A: 630A
DKS 125A: 630A
DNF 125A: 200A
BPD 125A: 200A
DNS 125A: 200A
DNP 250A: 400A
DNQ 125A: 200A
CKF 125A: 630A
DKF 125A: 630A

schermi di protezione contatti principali (utilizzare in alternativa ai copribarrette)
protection shield for main contacts (to be used instead of link bar covers)

Code



3 - 4° polo addossato - 3 and 4th leaning pole	EXNC33S		EXNC43S		EXNC53S
4 poli (polo laterale) - 4 pole (side pole)		EXCN34S		EXCN44S	EXNC54S
adatto per suitable for	CNS - DNS horizontal	125A:200A	250A:400A	630A:1000A	

schermi di protezione fusibili per CNF
fuse protection shield for CNF

Code

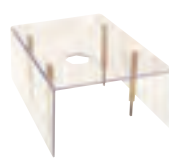
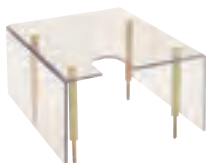

3 - 4° polo addossato - 3 and 4th leaning pole	EXNCF33		EXNCF43		EXNCF53
4 poli (polo laterale) - 4 pole (side pole)		EXCNF34		EXCNF44	EXNCF54
adatto per suitable for	CNF - DNF horizontal	125A:200A	250A:400A	630A:800A	

schermi di protezione fusibili per serie K
fuse protection shield for K series

Code

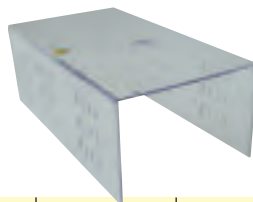

adatto per
suitable for

3 poli - 3 pole	EXKCF33		EXKCF43		EXKCF53		EXKCF63
4 poli - 4 pole		EXCKF34		EXCKF44		EXKCF54	EXKCF64
adatto per suitable for	CKF - DKF - CMF - DMF	125A:200A	250A:400A	630A:800A	800A:1250A		

schermi di protezione contatti principali per commutatori orizzontali CNS DNS 6-8 poli
protection shield for main contacts for CNS DNS 6-8 pole horizontal change-over switches



Code

adatto per
suitable for

6 poli - 6 pole	EXNC36S		EXNC46S		EXNC56S
8 poli - 8 pole		EXNC38S		EXNC48S	EXNC58S
adatto per suitable for	CNS - DNS horizontal	125A:200A	250A:630A (medium)	630A:1000A	

per una protezione completa del commutatore e del deviatore orizzontale tipo CNS 6-8 poli ordinare anche una copia di copriterminali (superiore e inferiore) per i contatti inferiori (vedi copriterminali per CNS a fondo pagina)

for a complete protection of horizontal change-over switches CNS type 6-8 pole order also top & bottom terminal covers (see CNS terminal covers)

schermi di protezione contatti principali con coprimorsetti inglobati per commutatori orizzontali CNP DNP 3-4 poli
 protection shield for main contacts and terminal covers for CNP DNP 3-4 pole horizontal change-over switches



Code

3 - 4° polo addossato - 3 and 4th leaning pole	EXNC33P		EXNC43P		EXNCP53P	
4 poli (polo laterale) - 4 pole (side pole)		EXNC34P		EXNC44P		EXNC54P
adatto per suitable for	CNP - DNP horizontal	250A:400A		630A:1000A		1250A:2000A

schermi di protezione contatti principali e coprimorsetti superiori ed inferiori per commutatori verticali CNQ CNP DNQ DNP 3-4 poli
 protection shield for main contacts and terminal covers for CNQ CNP DNQ DNP 3-4 pole vertical change-over switches

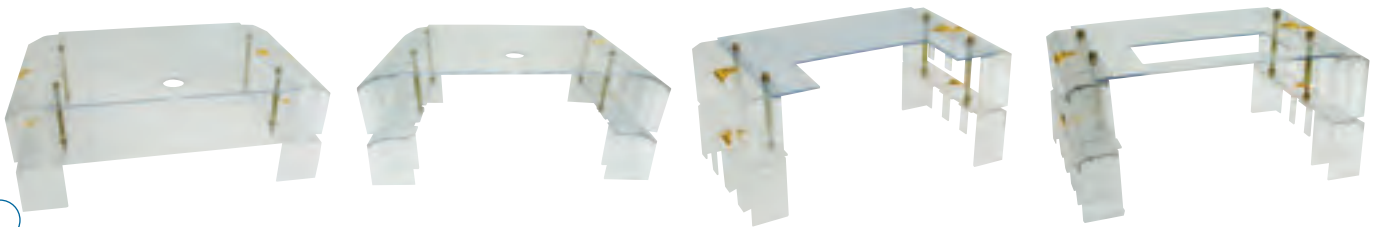

Code

3 - 4 polo addossato - 3 and 4th leaning pole	EXNC33Q		EXNC43Q		EXNC53Q	
4 poli (polo laterale) - 4 pole (side pole)		EXNC34Q		EXNC44Q		EXNC54Q
adatto per suitable for	CNQ - DNQ CNP - DNP vertical	125A:200A 250A:400A		250A:400A 630A:800A		----- 1000A:2000A

coprimerminali per 3 poli per serie K
 terminal cover for 3 pole for K series



Code

superiore - top	EXKCS33	EXKCS43	EXKCS53
inferiore - bottom	EXKCI33	EXKCI43	EXKCI53
adatto per suitable for	CKS - DKS CKM - DKM CKF - DKF CMF - DMF	125A:200A	250A: 630A 800A:1250A

coprimerminali per 4 poli per serie K
 terminal cover for 4 pole (side pole) for K series



Code

superiore - top	EXKCS34	EXKCS44	EXKCS54
inferiore - bottom	EXKCI34	EXKCI44	EXKCI54
adatto per suitable for	CKS - DKS CKM - DKM CKF - DKF CMF - DMF	125A:200A	250A: 630A 800A:1250A

coprimerminali per 3 poli e 4° polo addossato
 terminal cover for 3 pole and 4th leaning pole



Code

superiore - top	EXNCS33	EXNCS43	EXNCS53
inferiore - bottom	EXNCI33	EXNCI43	EXNCI53
adatto per suitable for	CNF - DNF CNS - DNS CNP - DNP	125A:200A 125A:200A 250A:400A	250A: 400A 250A: 630A 630A:1000A 1250A:2000A

coprimerminali per 4 poli (polo laterale)
 terminal cover for 4 pole (side pole)



Code

superiore - top	EXNCS34	EXNCS44	EXNCS54
inferiore - bottom	EXNCI34	EXNCI44	EXNCI54
adatto per suitable for	CNF - DNF CNS - DNS CNP - DNP	125A:200A 125A:200A 250A:400A	250A: 400A 250A: 630A 630A:1000A 1250A:2000A

copribarrette per contatti principali per CNS
link bar covers for main contacts for CNS



Code

	EXNCB3	EXNCB4	EXNCB5
adatto per suitable for	CNS-DNS 125A:200A	250A:630A	630A:1000A

copribarrette per attacchi uscita per serie K (pagine 2-6)
outgoing terminal protection shield for K series (pages 2-6)



vedi pg3-5 " see pg3-5

adatto per suitable for

Code

	EXKCB3	EXKCB4	EXKCB5
adatto per suitable for	CKS-DKS-CKM-DKM 125A:630A	250A:630A	630A:1000A

copriterminali per cavo
terminals cover for cable



Code

	EXKCP4	EXKCP5
adatto per suitable for	CKS - DKS 250A: 630A	800A:1250A
	CNF - DNF 250A: 400A	630A: 800A
	CNS - DNS 250A: 630A	630A:1000A
	CNP - DNP 630A:1000A	1250A:2000A

utilizzo con coprimorsetti fitted on terminal cover

utilizzo con copribarrette (CKS,DKS,CKM,DKM) fitted on outgoing terminal protection shield (CKS,DKS,CKM,DKM)

contatti ausiliari

a richiesta, tutti gli interruttori possono essere equipaggiati con contatti ausiliari che potranno essere anticipati o ritardati rispetto al contatto principale (come diagramma sottoriportato *). I contatti ausiliari possono essere protetti da una apposita calotta contro i contatti accidentali.

auxiliary contacts

on request, all switches can be equipped with auxiliary contacts, that can be leading or lagging as regard the main contacts (see the diagram below *). The auxiliary contacts can be protected with a cover against accidental touches.

i contatti ausiliari sono forniti completi di:
the auxiliary contacts are supplied complete with:



Legenda - Legend
 Aperto - Open
 Aperto - Open
 Chiuso - Closed

EXNCMAU



Code

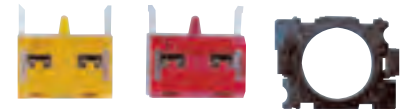

1 NO	1NO	1NC	1NO+1NC	1NO+1NC	1NO+1NO	1NO+1NO	1NC+1NC	2NO+2NC	2NO+2NC	2NO+2NO	2NO+2NO	2NC+2NC
EXNCAU1	EXNCAU1V	EXNCAU2	EXNCAU3	EXNCAU3V	EXNCAU4	EXNCAU4V	EXNCAU5	EXNCAU6	EXNCAU6V	EXNCAU7	EXNCAU7V	EXNCAU8

Code

(*)

potere di interruzione	AC11	V	24	110	220	380	600
		A	10	6,5	4,5	2,6	1,6
breaking capacity	DC11	V	24	110	220	380	600
		A	5	1,1	0,6	0,3	0,15

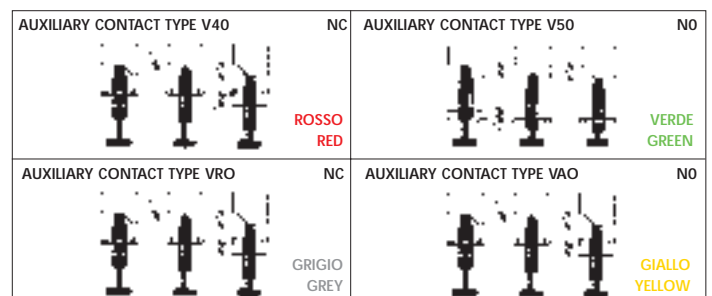

CONTACTPLASMA

la qualità certificata

La certificazione del Sistema di Qualità attesta la conformità del processo qualitativo attuato nell'Azienda alle Norme armonizzate europee UNI-EN ISO 9001, le quali definiscono i requisiti indispensabili che tali Sistemi devono possedere.

Si fa quindi riferimento all'affidabilità dei prodotti, dei servizi industriali ed alla loro rispondenza e garanzia di uniformità nel tempo. La CONTACTPLASMA srl, il 10 Giugno 1997, ha ottenuto da parte CISQ-RINA tale certificazione, per i processi di produzione sulla totalità dei suoi prodotti.

Registrazione IQNET
Certificato MOODY

No. IT-3166
No. 0312219

CONTACTPLASMA

Certified quality

The certification of CONTACTPLASMA quality system proves the conformity of the quality system carried out in the factory with the European standard UNI-EN ISO 9001, in which the essential requirements of such system are established. Therefore reference is made to the reliability of both products and industrial services and their conformance and uniformity guarantee in the long run.

On 10 June 1997 CONTACTPLASMA srl has obtained such certification from CISQ-RINA for the manufacturing processes of its complete range of products.

IQNET Registration
MOODY Certificate

No. IT-3166
No. 0312219





CAT 0302 BT



RICERCA TECNOLOGICA ELETTROMECCANICA ELETTROTECNICA BT-MT
 L.V.-M.V. ELECTROMECHANICAL AND ELECTROTECHNICS TECHNOLOGICAL RESEARCH

STABILIMENTI/FACTORY
 Via A. Gramsci, 2 - 26827 Terranova dei Passerini -LO- Italia
 Telefono +39 0377 833696 - 832120 fax +39 0377 830442
 www.contactplasma.it www.contactplasma.com
 e-mail management@contactplasma.it