

caratteristiche tecniche - technical characteristics  
**INP** (da pagina 18 a pagina 21 - from page 18 to page 21)

TIPO (SERIE) - TYPE (SERIES)	INP	INP	INP	INP	INP	INP	INP	INP	INP	INP	INP	INP	INP	INP	INP	INP	INP	INP	INP
<b>I<sub>th</sub></b> CORRENTE NOMINALE A T.A. MAX 401° RATED THERMAL CURRENT AT 40° MAX A.T.	in aria libera free air	A	250	400	630	800	1000	1250	1600	1800	2000	2500	3150	4000	5000	6300	7000	INP	INP
	in cassetta box	A	250	350	630	720	910	1250	1600	1600	1800	2200	2500	3400	4200	5500	6000	INP	INP
NUMERO DEI POLI - NUMBER OF POLES	--	--	3-4	3-4	3-4	3-4	3-4	3-4	3-4	3-4	3-4	3-4	3-4	3-4	3-4	3-4	3-4	INP	INP
<b>U<sub>i</sub></b> TENSIONE D'ISOLAMENTO - RATED VOLTAGE OF ISOLATION	c.c./a.c.	V	1000	1000	1000	1000	1000	1000	1000	1000	1000	1000	1000	1000	1000	1000	1000	1000	1000
	c.c./d.c.	V	600	600	600	600	600	600	600	600	600	600	600	600	600	600	600	600	600
		kV	8	8	8	8	8	8	8	8	8	8	8	8	8	8	8	8	8
TENSIONE DI TENUTA AD IMPULSO - IMPULSE WITHSTAND VOLTAGE	--		8	8	8	8	8	8	8	8	8	8	8	8	8	8	8	8	8
<b>I<sub>e</sub></b> CORRENTE D'IMPIEGO - OPERATIONAL CURRENT AC21	500 V	A	250	400	630	800	1000	1250	1600	1800	2000	2500	3150	4000	5000	6300	7000	INP	INP
	500 V	A	250	400	630	800	1000	1250	1600	1600	1600	2000	2100	2200	2500	2600	2600	INP	INP
	500 V	A	250	400	630	630	800	--	--	--	--	--	--	--	--	--	--	INP	INP
POTENZA REATTIVA - REACTIVE POWER <i>note (1)</i>	380 V	kVar	125	200	280	300	320	400	500	--	--	--	--	--	--	--	--	--	--
<b>I<sub>sw</sub></b> CORRENTE DI BREVE DURATA RATED SHORT-TIME WITHSTAND CURRENT	1 sec	kA r.m.s.	19	21	32	36	40	40	50	55	60	80	85	85	100	120	120	INP	INP
	500 V	kA peak	40	45	67	76	84	84	105	121	132	176	187	187	200	200	200	INP	INP
DURATA MECCANICA - MECHANICAL ENDURANCE	operazioni operations	n°	8000	5000	5000	3000	3000	3000	3000	3000	3000	3000	2000	2000	2000	2000	2000	2000	2000
	operazioni operations	n°	1000	1000	1000	500	500	500	500	500	500	500	500	500	500	500	500	500	500
PESO - WEIGHT INP 3 pole	--	Kg	3	3,2	5,2	6,3	6,3	12,5	13,5	17,5	17,5	45	45	45,6	82,5	92,5	92,5	INP	INP
	--	Kg	3,1	--	5,5	--	--	--	--	--	--	--	--	--	--	--	--	INP	INP
	--	Kg	3,8	4	6	7,3	7,3	14,5	17	22	22	54	54	54,8	110	110	120	INP	INP

*note (1)* a causa delle armoniche e delle tolleranze dei condensatori, i valori nominali devono essere ridotti del 33% - due to harmonics and tolerance of the capacitors, the rated values have been reduced by 33%

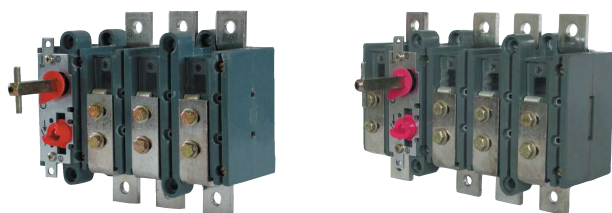

codici per ordini - ordering codes

INP	250A	400A	630A	800A	1000A	1250A	1600A	1800A	2000A
3 pole	EINP02503300A	EINP04003300A	EINP06303300A	EINP08003300A	EINP10003300A	EINP12503300A	EINP16003300A	EINP18003300A	EINP20003300A
4 pole Note (5)	EINP02504301A	-	EINP06304301A	-	-	-	-	-	-
4 pole Note (1)	EINP02504302A	EINP04004302A	EINP06304302A	EINP08004302A	EINP10004302A	EINP12504302A	EINP16004302A	EINP18004302A	EINP20004302A
4 pole Note (6)	EINP02504303A	-	EINP06304303A	-	-	-	-	-	-
4 pole Note (2)	EINP02504304A	EINP04004304A	EINP06304304A	EINP08004304A	EINP10004304A	EINP12504304A	EINP16004304A	EINP18004304A	EINP20004304A
4 pole Note (3)	EINP02504307A	EINP04004307A	EINP06304307A	EINP08004307A	EINP10004307A	EINP12504307A	EINP16004307A	EINP18004307A	EINP20004307A

Note (5) 4.to polo addossato sezionato  
4th leaning switched pole

Note (1) 4.to polo laterale sezionato  
4th side switched pole

Note (6) 4.to polo addossato passante non sezionabile  
4th leaning unswitched pole

Note (2) 4.to polo laterale passante non sezionabile  
4th side unswitched pole

Note (3) 4.to polo laterale passante sezionabile  
4th side switchable pole

Per vedere le fotografie dei neutri andare a pagina 48  
See page 48 for 4th pole photos

INP 250A÷2000A 3 poli  
INP 250A÷2000A 4° polo addossato  
INP 250A÷2000A 3 polo  
INP 250A÷2000A with 4th leaning pole

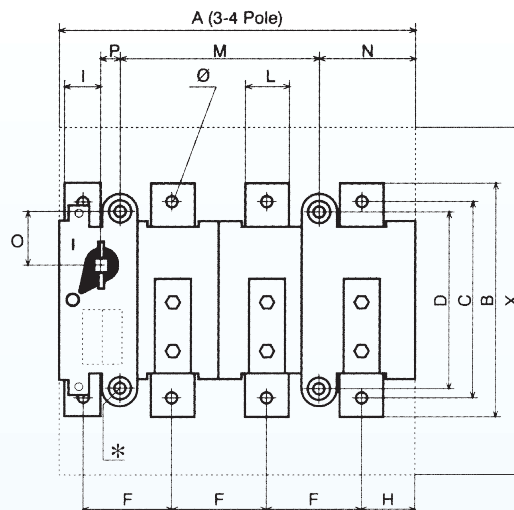
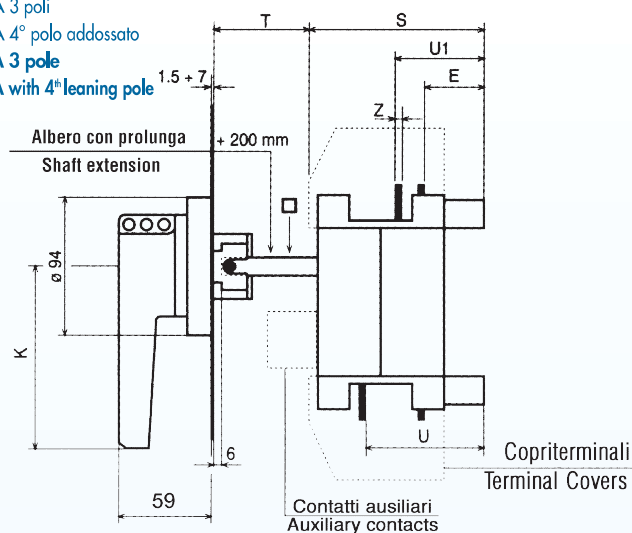

	A	A	B	C	C <sub>1</sub>	D	E	F	H	I	K	L	M	N	O	P	S	T	U	U <sub>1</sub>	Z	X	□	∅	*
	3-4 pole	4 pole																							
INP 250A	181	181	153	128	-	107	29	44	32	16	125	25	98	51	33	6	98	60	57	45	4	178	10	10,5	5,5
INP 400A	181	-					5																		
INP 630A	256	256	200	167	-	119	37	65	42	25	125	30	137	72	36	12	115	70	70	50	5	234	12	12,5	6,5
INP 800A	256	-					10																		
INP 1000A		-					10																		
INP 1250A	325	-	353	317	267	176	-	87	49	40	165	40	174	92	64	19,5	150	118	80	90	10	333	12	12,5	7
INP 1600A			79	91	12																				
INP 1800A			20	20	20																				
INP 2000A			75	95	20																				

Per ordinare i sezionatori INP con manovra inversa (I-0) vedi pagina 42 nota D.  
See page 42 note D to order INP switches with anticlockwise operation (I-0)

nota: per gli ordini in Italia sostituire con la J la E iniziale nel codice prodotto

altre tabelle dimensionali e disegni a pag. 19  
see page 19 for other dimensional tables and drawings

INP 250A÷2000A 4° polo laterale  
 INP 250A÷2000A with 4<sup>th</sup> side pole

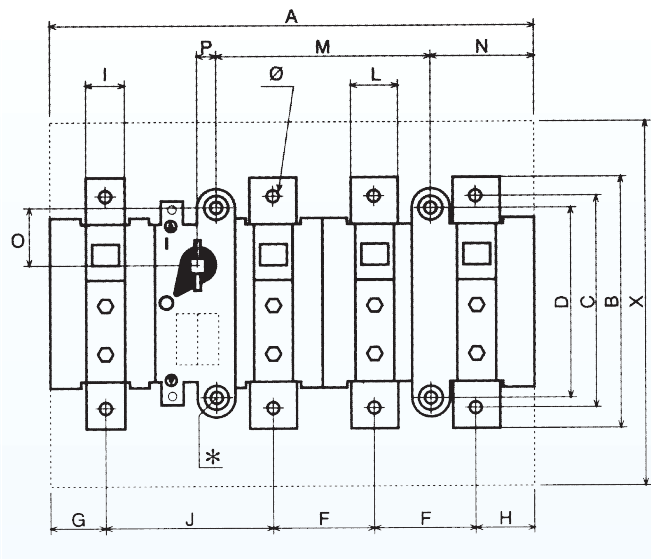
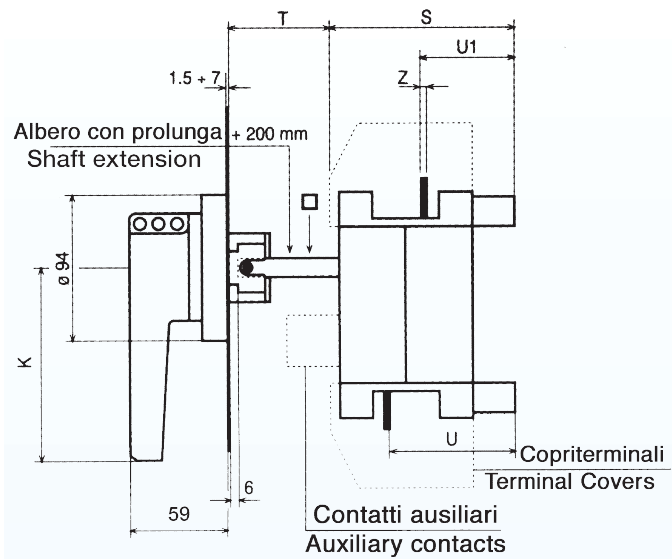

	A	B	C	Ø	D	F	H	G	I	J	K	L	M	N	O	P	S	T	U	U <sub>1</sub>	Z	X	□	*
INP 250A	222	153	128	10,5	107	44	32	20	25	82	125	25	98	51	33	6	98	60	57	45	4	178	10	5,5
INP 400A																					5			
INP 630A	306	200	167	12,5	119	65	42	25	30	109	125	30	137	72	36	12	115	70	70	50	5	234	12	6,5
INP 800A																					10			
INP 1000A																					10			
INP 1250A	378	353	316	12,5	176	87	49	25	40	130	165	40	174	92	64	19,5	150	118	80	90	10	334	12	7
INP 1600A																			79	91	12			
INP 1800A																			20					
INP 2000A																			75	95	20			

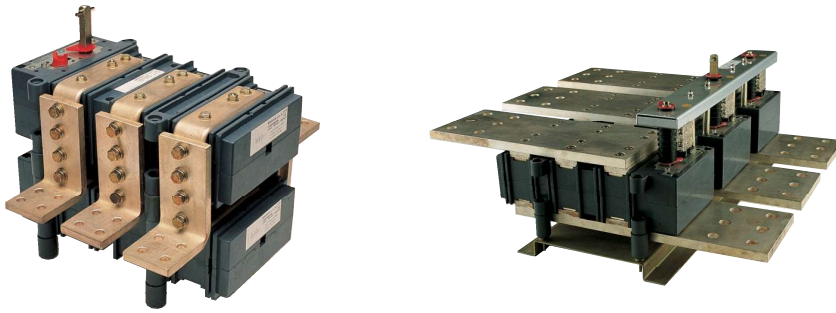

codici per ordini - ordering codes

INP	2500A	3150A	4000A	5000A	6300A	7000A
3 pole	EINP25003000A	EINP31503000A	EINP40003000A	EINP50003000A	EINP63003000A	EINP70003000A
4 pole	EINP25004002A	EINP31504002A	EINP40004002A	EINP50004002A	EINP63004002A	EINP70003000A

INP 2500A÷4000A 3-4 poli  
INP 2500A÷4000A 3-4 pole

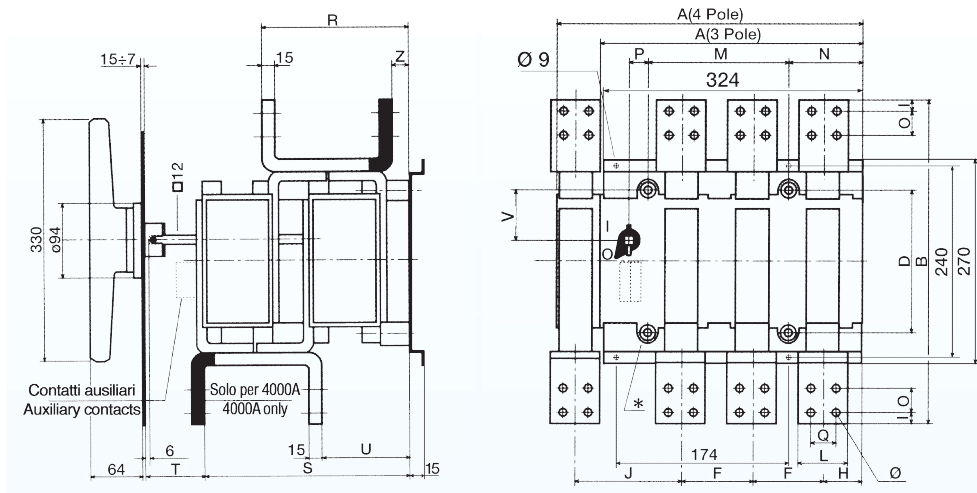

	A	A	B	D	F	H	J	I	L	M	N	O	P	Q	R	S	T	U	V	*	Ø	Z
	3 pole	4 pole																				
INP 2500A																						
INP 3150A	324	377	440	176	107	29	110	20	80	174	92	64	19,5	40	176	262	143	120	64	7	12,5	40
INP 4000A																						

INP 5000A÷6300A 3-4 poli  
INP 5000A÷6300A 3-4 pole

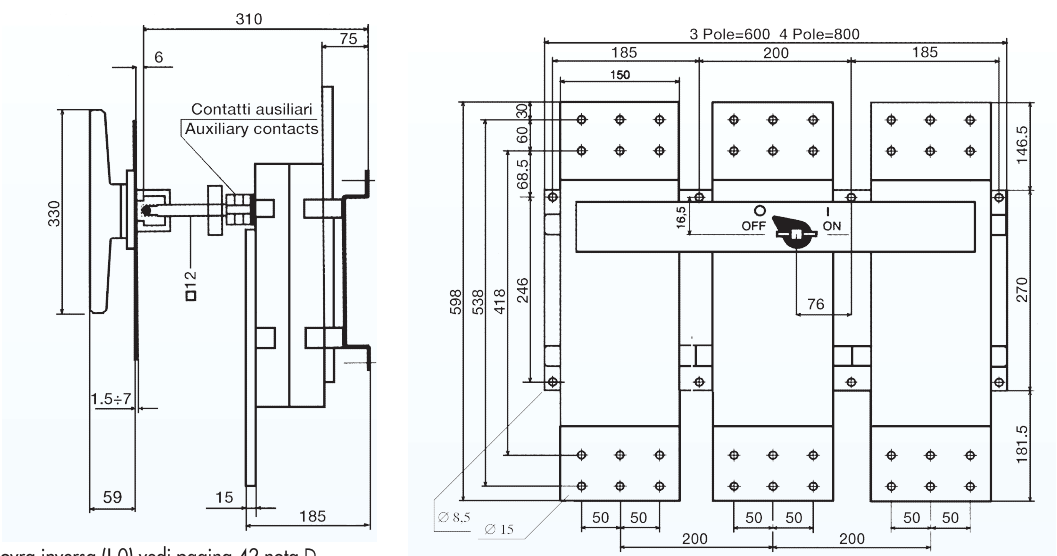

Per ordinare i sezionatori INP con manovra inversa (I-0) vedi pagina 42 nota D.  
**See page 42 note D to order INP switches with anticlockwise operation (I-0)**  
**nota:** per gli ordini in Italia sostituire con la J la E iniziale nel codice prodotto

INP 7000A 3-4 poli  
INP 7000A 3-4 pole

